



calma.

calma collection

ALAT

P. 04



ANGLE

P. 12

BOLET

P. 14

CIRCUS

P. 16

COQUETA

P. 18



DORM

P. 20

DUE

P. 24

LOLA

P. 28



LLUM

P. 30

XICA & XANCA

P. 33



NEW!

LOU

P. 36

MAREA

P. 40



NEW!

MARIA

P. 45

NUA

P. 47

OM

P. 49

TEN

P. 54

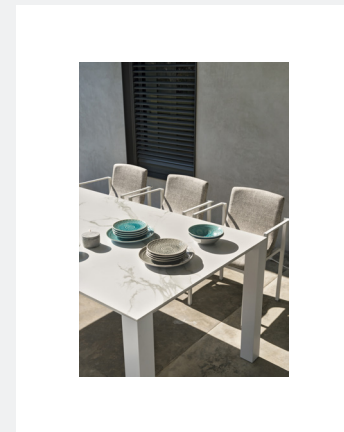

PEPA

P. 56

TRAMA & MALLA

P. 59

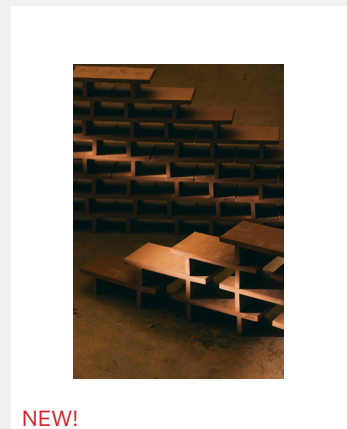

NEW!

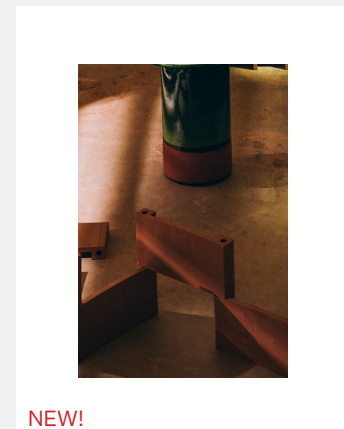

NEW!

calma.

alat



calma.

alat wood



ALAT LOUNGE SOFA

A sofa of titanic proportions.

Monumental and Monolithic. “Alat” which means “winged” in Catalan, takes basic geometric cues from brutalism, giving it a heavy appearance and a feeling of robustness that contrasts with the visual lightness of the lateral wings.

Alat fuses the sofa with the archetypal lounge, making it useful as both while defining itself as something totally reimagined.

DESIGN:
ANDREU CARULLA



DESIGN: ANDREU CARULLA



ALAT WOOD

It is a variant in the ALAT collection presented in a single dimension, 350cm long. The main structure is made of natural fir wood, without any treatment or protection.

The construction accessories are made of stainless steel and aluminum.

The cushions of the Alat collection are formed with comfort foams of different densities, covered with a protective waterproof inner cover, and the outer shell construction with Silvertex vinyl fabric in white (Ice) or black (Carbon) , in Acrylic Sunbrella Savane Zinc color and in Agora Bruma

MATERIALS / COLOURS

Iroko



Sunbrella



J236 zinc

Silvertex

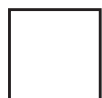

4004 ice



9002 carbon

Agora



1003 Bruma

SIZE	REF. 854	
WIDTH	350 CM	138"
DEPTH	110 CM	43"
HEIGHT	72 CM	28"
N.W.	115 KG	

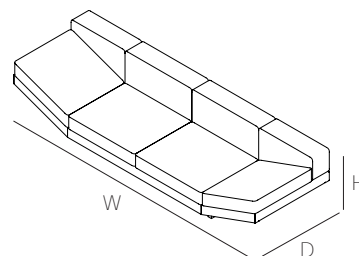

UN/BOX:	1/3
BOX SIZE:	206X116X78 CM 2/ 80X116X78 CM
VOL:	3,300 M3
G.W.:	140 KG



calma.

alat alu



ALAT MODULAR LOUNGE SOFA

A sofa of titanic proportions.

Alat is a simple invitation to lie down informally, a sassy proposal for relax with no complex, provocative because of its shape and dimensions.

With an aluminum structure texturize powder coated painted, it comes in 2 options of color, white and charcoal (dark gray). The cushions are upholstered in Sunbrella Savane fabrics, Zinc color

DESIGN:
ANDREU CARULLA



DESIGN: ANDREU CARULLA



MODULAR SOFA

Alat is a collection of lounge sofas of titanic proportions. Of austere appearance, its shape permits various modular configurations. Its winged sides give the user multiple ways of sitting or laying down.

The structure is constructed either from extruded aluminium profiles of varying dimensions and powder coated in the oven and available in two colours or a solid pine timber frame.

The cushions of Alat are filled with various densities of foam. wrapped in a protective cover and housed in an exterior case in Silvertex or Sunbrella fabric.

MATERIALS / COLOURS

Aluminium



11 white



13 black

Sunbrella



J236 zinc

Silvertex

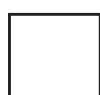

4004 ice



9002 carbon

SIZE	REF. 851	
WIDTH	350 CM	138"
DEPTH	110 CM	43"
HEIGHT	72 CM	28"
N.W.	145 KG	

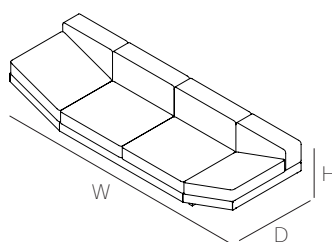

UN/BOX:	1/3	
BOX SIZE:	206X116X78 CM 2/ 80X116X78 CM	
VOL:	3,300 M3	
G.W.:	165 KG	

SIZE	REF. 852	
WIDTH	450 CM	177"
DEPTH	110CM	43"
HEIGHT	72 CM	28"
N.W.	170 KG	

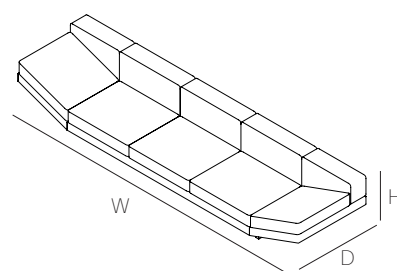

UN/BOX:	1/2	
BOX SIZE:	306X116X78 CM 90X116X37 CM	
VOL:	3,156 M3	
G.W.:	190 KG	



DESIGN: ANDREU CARULLA



SIZE	REF. 853-3	
WIDTH	76 CM	30"
DEPTH	111 CM	44"
HEIGHT	72 CM	28"
N.W.	35 KG	

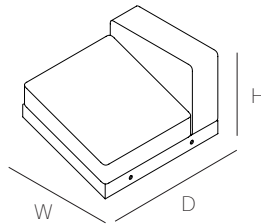

UN/BOX:	1/1
BOX SIZE:	90X115X60 CM
VOL:	0,6 M3
G.W.:	40 KG

SIZE	REF. 853-1	
WIDTH	200 CM	77"
DEPTH	111 CM	44"
HEIGHT	72 CM	28"
N.W.	74 KG	

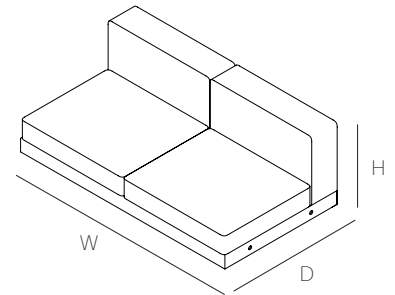

UN/BOX:	1/1
BOX SIZE:	204X115X76
VOL:	1,80 M3
G.W.:	85 KG

MODULAR SOFA

Alat is a collection of lounge sofas of titanic proportions. Of austere appearance, its shape permits various modular configurations. Its winged sides give the user multiple ways of sitting or laying down.

The structure is constructed either from extruded aluminium profiles of varying dimensions and powder coated in the oven and available in two colours or a solid pine timber frame.

The cushions of Alat are filled with various densities of foam. wrapped in a protective cover and housed in an exterior case in Silvertex or Sunbrella fabric.

SIZE	REF. 853-6	
WIDTH	111 CM	44"
DEPTH	111 CM	44"
HEIGHT	72 CM	28"
N.W.	54 KG	

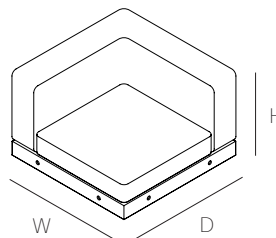

UN/BOX:	1/1
BOX SIZE:	115X115X76 CM
VOL:	1,00 M3
G.W.:	60 KG

SIZE	REF. 853-8	
WIDTH	32 CM	13"
DEPTH	85 CM	33"
HEIGHT	41 CM	16"
N.W.	11 KG	

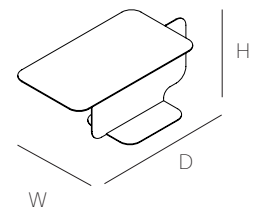

UN/BOX:	1/1
BOX SIZE:	36X89X45 CM
VOL:	0,15 M3
G.W.:	15 KG

MATERIALS / COLOURS

Aluminium



11 white



13 black

Sunbrella



J236 zinc

Silvertex

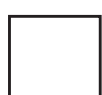

4004 ice



9002 carbon

calma.

alat daybed



ALAT DAYBED

An evolution of the award-winning Alat Sofa, the Alat Daybed is comfort at epic proportions. An ample piece of furniture that shelters the user with an all-covering slatted screen, making it a cozy alcove for outdoor use.

DESIGN:
ANDREU CARULLA



DESIGN: ANDREU CARULLA



ALAT DAYBED

ALAT DAYBED is a double extra-large lounger with a large canopy, which extends the ALAT collection family.

Structure of aluminum powder coated textured painted, measures of 280x200x210cm. All the exterior of the Daybed ALAT, is made with a blind of fir wood, providing shadows and wefts for sun protection.

The cushions of this product are made with high comfort technical foams and protected with an inner waterproof cover of heat-sealed seams. The exterior finish available in different acrylic or technical fabrics

MATERIALS / COLOURS

Aluminio



14 mocca

Sunbrella



J236 zinc

Silvertex



4004 ice



9002 carbon

Agora



1003 Bruma

SIZE REF. 856

WIDTH	280 CM	110"
DEPTH	206 CM	81"
HEIGHT	204 CM	80"

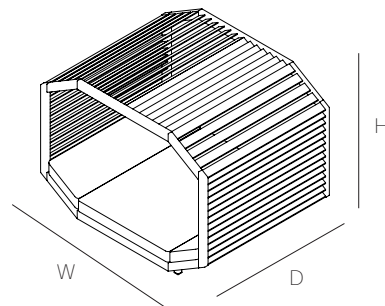

ESTRUCTURE 1

BOX SIZE: 210X154X60 CM

G.W.: 220 KG

ESTRUCTURE 2

BOX SIZE: 265X40X16 CM

G.W.: 20 KG

BASE CUSHIONS

BOX SIZE: 152X72X85 CM

G.W.: 30 KG

WING CUSHIONS

BOX SIZE: 105X72X85 CM

G.W.: 25 KG

calma.

angle



ANGLE

As a game of inclined planes,... Pure geometry

Angle is a table for large spaces, sculptural, architectural, but, at the same time, it is delicate and elegant. A project of apparent simplicity, but which has detailed technical work.

DESIGN:
SERRAYDELARROCHA



DESIGN: ANDREU CARULLA



TABLE

Angle is an exercise of design where the new material has been the essence and the motivation. SerraydelaRocha highlight that “its geometry has been studied at the structural level to get maximum rigidity in the simplest way, achieving a visual effect of lightness”.

SIZE	REF. 902	
WIDTH	340 CM	134"
DEPTH	105 CM	41"
HEIGHT	73 CM	30"
N.W.	178 KG	

MATERIALS / COLOURS / FINISHINGS

Aluminium

Dekton



11 white



ZN Zenit



19 Taupe



GL galema

UN/BOX:	1/5	
BOX SIZE:	138X113X8 CM	
	115X113X8 CM	
	115X113X8 CM	
	110X106X54 CM	
	177X96X32 CM	
VOL:	1,507 M3	
G.W.:	196 KG	





BOLET

Glazed ceramic outdoor stool

Bolet is both an exercise in functionalism and an ode to craftsmanship. The geometry of Bolet is achieved with a simple transformation to the clay extrusion process. Making it useful as both a stool and occasional side-table. Fired at a high heat, it is able to withstand extreme changes in temperature making it ideal for both indoor and outdoor use. Dip-glazed in traditional La Bisbal colours, the hardness of its material is softened with a generous natural cork base and three holes on top provide a convenient way of moving it with ease.

Utilitarian, local and warm. Bolet embodies a new approach to a traditional proce

DESIGN:
ANDREU CARULLA



DESIGN: ANDREU CARULLA



BOLET

Bolet is a stool/occasional side table made from traditional ceramic, hardened at 1070°C in the kiln, Bolet is resistant to the harshest changes in temperature and is able to withstand extreme climates.

It comes in various traditional glaze colours.

SIZE	REF. 257	
WIDTH	Ø35 CM	14"
HEIGHT	40 CM	16"

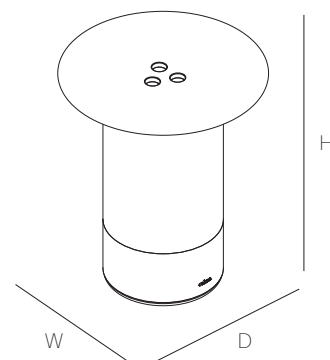

MATERIALS / COLOURS

Ceramics



Colors



GR Green



BL Blue



YL Yellow



BR Brown

UN/BOX:	1/1
BOX SIZE:	Ø36X43 CM
VOL:	0,06 M3
G.W.:	9 KG





CIRCUS SIDETABLES

Versatile stackable sidetables.

After introducing our *Senyora* Collection, Andreu Carulla has designed Circus. A collection of stackable sidetables for the outdoor furniture brand that complement the seating collection perfectly.

DESIGN:
ANDREU CARULLA

DESIGN: ANDREU CARULLA



Ref. 551



Ref. 552



Ref. 553



Ref. 550

SIZE	REF. 551	
DIAMETER	60 cm	24"
HEIGHT	56 cm	22"
N.W.	5,40 kg	
UN/BOX:	1/1	
BOX SIZE:	62x62x58 cm	
VOL:	0,242 m ³	
G.W.:	6,60 kg	

SIZE	REF. 552	
DIAMETER	50 cm	20"
HEIGHT	46 cm	18"
N.W.	3,90 kg	
UN/BOX:	1/1	
BOX SIZE:	52X52X48 cm	
VOL:	0,127 m ³	
G.W.:	4,90 kg	

SIZE	REF. 553	
DIAMETER	40 cm	16"
HEIGHT	36 cm	14"
N.W.	2,70 kg	
UN/BOX:	1/1	
BOX SIZE:	42X42X38 cm	
VOL:	0,007 m ³	
G.W.:	3,30 kg	

SIZE	REF. 550	
SET DE MESAS		
N.W.	12 kg	
UN/BOX:	1/1	
BOX SIZE:	62X62X58 cm	
VOL:	0,242 m ³	
G.W.:	13,50 kg	

STACKABLE SIDETABLES

Collection of 3 stackable side tables made from 12mm steel rod, powder coated in the oven with a tabletop in 10mm thick HPL. Easy assembly with no need for tools. Where the structure meets the ground, round corners are protected with nylon feet.

MATERIALS / COLOURS

STEEL FRAME: INOX



11 white



14 mocca

TABLETOP: HPL



41 white



44 beige

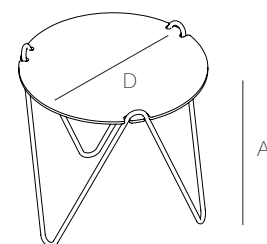

calma.

coqueta



COQUETA

A woven wicker armchair

Calma has rescued one of Spain's great design classics for its new collection. Bestowed with a Gold Delta Award in 1988, the country's most coveted design award, the Coqueta chair by Pete Sans is both a carefully balanced and a radical piece of design. A milestone in the history of Spanish design, a basket-weave seat is suspended from its seamless stainless steel structure, all of which is held together with its most identifiable detail: a buckled belt which spans the length of the chair.

DESIGN:
PETE SANS



DESIGN: PETE SANS



Ref. 341 inox



Ref. 341 black

COQUETA





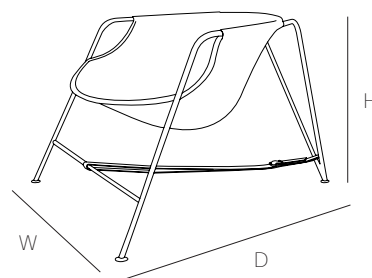

A design classic in the history of Spanish design, this armchair is characterised by its woven basket seat that is suspended from a stainless steel frame. These components are structurally strengthened by a buckled belt that spans the length of the chair, providing tension.

Available in two finishes, a natural and a black, where the former is characterised by a natural colour woven seat and polished stainless steel frame. The latter is characterised by an all black look, with a black-coated frame and a black woven seat.

SIZE	REF. 341	
WIDTH	94 CM	37"
DEPTH	96 CM	38"
HEIGHT	65 CM	26"
N.W.	5 KG	



MATERIALS / COLOURS

Ref. 341 inox	Frame	Wicker	Belt
			
	Stainless steel	Natural	Natural leather
Ref. 341 black	Frame	Wicker	Belt
			
	Black steel	Black	technical strap

UN/BOX:	1/1
BOX SIZE:	98X100X70 CM
VOL:	0,68 M3
G.W.:	9 KG





DORM MODULAR SOFA

A soft-modular outdoor sofa

Designed to be a discreet and reliable piece of outdoor furnishing, dorm is a modular sofa that is versatile in its simplicity. Featuring detachable and waterproof fabric cushions and stainless steel feet.

DESIGN:
SERRAYDELAROCHA

calma.

dorm

DESIGN: SERRAYDELARROCHA



DESIGN: SERRAYDELARROCHA



MODULAR SOFA

Dorm is a collection of upholstered modular sofas with an internal structure made from rotation-moulded 100% recyclable polyethylene. Its cushions are made from a combination of technical foams for maximum comfort and protected by a removable waterproof fabric.

Each module is separated by a stainless steel structure that permits drainage between backrest, seat cushion and armrest. The feet are in stainless steel polished to a high shine.

UPHOLSTERY

SILVERTEX® Multilayer vinyl and polyester with a density of 685 gr/m². Protected by **SILVERGUARD®** Natural bacterial resistance. Prohibits the growth of bacteria by way of Ag ions (silver) and **PERMABLOK®** anti-bacterial and anti-microbial activity, high resistance to abrasion and highly resistant to stains.

CHARTRES The raw material of the material is dyed-acrylic **Sunbrella®**. In the pre-production phase of its fabrication, before making the thread, colour is incorporated on a fibre-level. Giving Sunbrella® their characteristic sun resistance and weather resistance

NATTÉ is an incredibly resistant fabric in 100% Sunbrella acrylic. with a 5 year guarantee, it is fade resistant and easy to clean.

DOLCE VITA

In every case, the fabric is removable.

MATERIALS / COLOURS

SILVERTEX



4004 ice



0009 taupe



9002 carbón

SUNBRELLA CHARTRES



f025 carbon



f027



f028 dove



f026 shale

SUNBRELLA NATTÉ



10083 dusk



10022 grey chiné

DOLCE VITA



Bandolero Y



Bandolero S

DESIGN: SERRAYDELARROCHA



Fundas hibernación con tejido Seaguard Flex de Sunbrella®

SIZE	REF. 811	
WIDTH	128 cm	50"
DEPTH	100 cm	39"
HEIGHT	67 cm	26"
N.W.	42,2 kg	



UN/BOX:	1/1	
BOX SIZE:	131X103X66 cm	
VOL:	0,891 m ³	
G.W.:	51 kg	

SIZE	REF. 814	
WIDTH	160 cm	63"
DEPTH	100 cm	39"
HEIGHT	67 cm	26"
N.W.	49 kg	



UN/BOX:	1/1	
BOX SIZE:	164X103X66 cm	
VOL:	1,115 m ³	
G.W.:	58 kg	

SIZE	REF. 815	
WIDTH	160 cm	63"
DEPTH	100 cm	39"
HEIGHT	67 cm	26"
N.W.	49 kg	



UN/BOX:	1/1	
BOX SIZE:	164X103X66 cm	
VOL:	1,115 m ³	
G.W.:	58 kg	

SIZE	REF. 816	
WIDTH	192 cm	76"
DEPTH	100 cm	39"
HEIGHT	67 cm	26"
N.W.	56 kg	



UN/BOX:	1/1	
BOX SIZE:	196X103X66 cm	
VOL:	1,339 m ³	
G.W.:	65 kg	



calma.

due



calma.

due



DUE COLLECTION

The fine curved lines join the sinuosity of our body's own curves, to brace it and coddle it naturally in unique moments of its life.

DESIGN:
CROUSCALOGERO



DESIGN: CROUSCLOGERO



ARMCHAIR

Stackable armchair with an aluminum structure painted in the oven, and seat and back in pre-stressed Batyline ISO fabric with thermos welded seams.

It comes in 2 options of color combinations, structure and fabric entirely white, and structure and fabric entirely in Taupe.

MATERIALS / COLOURS

Aluminium frame



11 white



19 taupe

Batyline ISO



61 white



63 taupe

SIZE	REF. 321	
WIDTH	54 CM	21"
DEPTH	60 CM	24"
HEIGHT	80 CM	31"
N.W.	4,7 KG	

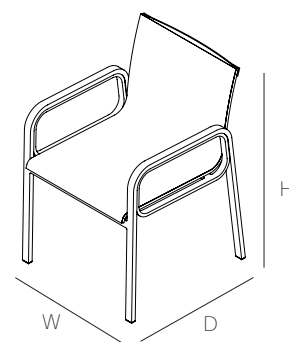

UN/BOX:	2/1
BOX SIZE:	63X57X104 CM
VOL:	0,373 M3
G.W.:	16 KG



DESIGN: CROUSCLOGERO







MESAS COMEDOR

It comes in 2 options of color combinations, structure and fabric entirely white, and structure and fabric entirely in Taupe.

The DUE table consists of a tubular structure in oven-painted aluminum, and a 10mm thick HPL countertop. Two options for colors of structure, white and taupe, two options also for countertop finishing, white and Decor Wood.

MATERIALS / COLOURS

Frame	Top
	
11 white	41 taupe
Frame	Top
	
19 taupe	45 wood

SIZE	REF. 332	
WIDTH	98 CM	39"
DEPTH	265 CM	76"
HEIGHT	74 CM	29"
N.W.	52 KG	

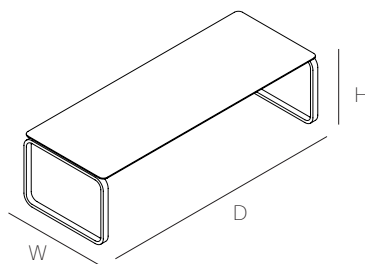

UN/BOX:	1/1
BOX SIZE:	269X102X17 CM
VOL:	0,466 M3
G.W.:	70 KG

SIZE	REF. 331	
WIDTH	98 CM	39"
DEPTH	192 CM	76"
HEIGHT	74 CM	29"
N.W.	52 KG	

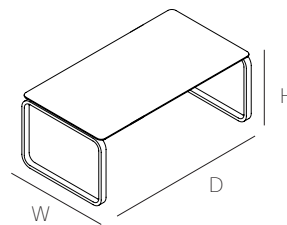

UN/BOX:	1/1
BOX SIZE:	196X102X17 CM
VOL:	0,340 M3
G.W.:	56 KG





LOLA

Lola, popular, dynamic, courageous and very practical, Sra Lola is the typical lady who seems you have known her your entire life, but inside she is really different. It looks delicate but is very resistant.

DESIGN:
ANDREU CARULLA

DESIGN: ANDREU CARULLA



DINING CHAIR

Stackable Structure in massive steel rod 12 mm galvanized and powder painted, leg protectors in Nylon, fully adaptable to Sra sys- tem.

SIZE	REF. 643	
WIDTH	48 CM	19"
DEPTH	61 CM	24"
HEIGHT	84 CM	32"
N.W.	8 KG	

MATERIALS / COLOURS

Aluminium



11 white

Batyline Eden



0567 silver



0557 blue

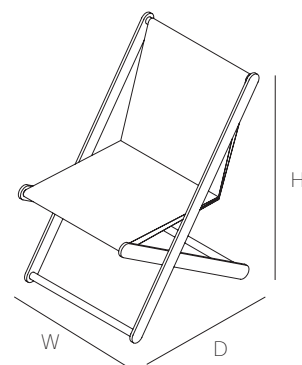

UN/BOX:	4/1
BOX SIZE:	69X51X105 CM
VOL:	0,369 M3
G.W.:	34 KG



calma.

llum





LLUM OUTDOOR LAMP

Outdoor Lamp made of polyethylene, which illuminates in all directions, and is suspended on three wooden feet. Designed to provide warmth, comfort and light in both indoor and outdoor spaces.

DESIGN:
CROUSCALOGERO

DESIGN: CROUSCLOGERO



REF. 701



REF. 702

OUTDOOR LIGHTING

LLUM is Calma's first lamp. It is based on a rotomolded polyethylene balloon, supported by 3 feet of Iroko wood suitable for outdoor use, and incorporates a 4000K LED bulb. It comes in 2 heights: 80 and 120 cm

MATERIALS / COLOURS

PE



21 white natural

WOOD



53 iroko

SIZE	REF. 701	
DIÁMETER	50 CM	20"
HEIGHT	85 CM	33"
N.W.	5,10 KG	

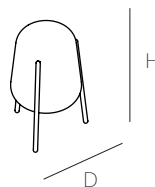

UN/BOX:	1/1	
BOX SIZE:	52X52X87 CM	
VOL:	0,230 M3	
G.W.:	6,4 KG	

SIZE	REF. 702	
DIÁMETER	60 CM	20"
HEIGHT	120 CM	47"
N.W.	6,4 KG	

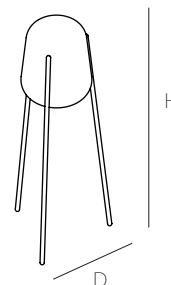

UN/BOX:	1/1	
BOX SIZE:	62X62X122 CM	
VOL:	0,461 M3	
G.W.:	7 KG	



calma.

xica & xanca



calma.

xica & xanca



OUTDOOR LAMP

Three natural timber legs suspend a white frosted globe in mid air, permitting illumination in every direction. Designed to provide outdoor warmth and light during short summer nights and indoor comfort during the long winters, Xica i Xanca is a versatile collection that brings a space to life without distraction or excess.

DESIGN:
CROUSCALOGERO



DESIGN: CROUSCLOGERO



REF. 704



REF. 703

OUTDOOR LIGHTING

These 2 lamps join the LLUM family to expand the collection. The special feature is that they incorporate an IP65 luminaire, battery powered charge by induction without the need for external cables and a 290 lumen bulb.

The one-piece rotomold polyethylene housing in natural color, allows the diffusion of light in a regular and proportionate intensity. The structure consists of 3 legs of Iroko wood and come in 2 measures.

MATERIALS / COLOURS

PE

WOOD



21 white natural

53 iroko

SIZE	REF. 703	
DIÁMETER	29 CM	11"
HEIGHT	32 CM	13"
N.W.	2 KG	

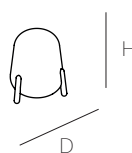

UN/BOX:	1/1	
BOX SIZE:	30X30X34 CM	
VOL:	0,03 M2	
G.W.:	2,5 KG	

SIZE	REF. 704	
DIÁMETER	42 CM	17"
HEIGHT	96 CM	38"
N.W.	2,5 KG	

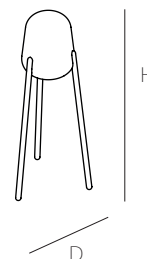

UN/BOX:	1/1	
BOX SIZE:	45X45X100 CM	
VOL:	0,20 M3	
G.W.:	3,00 KG	





LOU

Relaxed soft-furniture collection

Lou is the result of the first collaboration between the studio of Inma Bermúdez and Calma. The collection comprises three pieces: a pouf, a lounge chair and a sofa. We like to call them “soft” furniture. The seat cushion is made from various layers of viscoelastic, making it remarkably comfortable. When removed during the winter months, Lou still retains a sculptural appearance due to its delicately light wire frame.

DESIGN:
STUDIO INMA BERMUDEZ



DESIGN: STUDIO INMA BERMUDEZ



LOU

This is a complete collection for relax , composed of armchair, 2 seater sofa, pouf, coffee table, gardener and brazier.

The structure is made of solid steel rod, with previous protection of zinc and powder coated painted.

The seat cushions are formed by a combination of comfort foams, with an inner waterproof cover of technical fabric and heat-sealed seams, and an outer sheath confection with Sunbrella LOPI acrylic fabric, in different colors. The collection is accompanied by additional decoration cushions.

MATERIALS / COLOURS

Colors



Green 6003

Sunbrella



Lopi Sand



Lopi Blush

Decorative cushions



Solids Pumkin



Solids Mint



Solids Blush



Heritage Leaf

SIZE	REF: 352	
DIÁMETER	Ø88 CM	35"
HEIGHT	62 CM	24"
N.W.	18 KG	

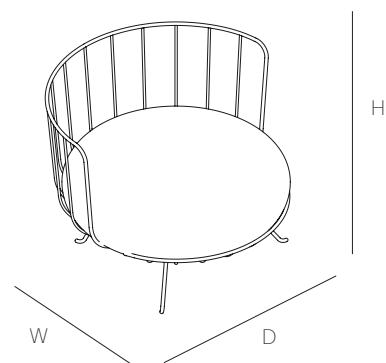

UN/BOX:	1/1
BOX SIZE:	92X87X68 CM
VOL:	0,55 M3
G.W.:	25 KG



DESIGN: STUDIO INMA BERMUDEZ



LOU

This is a complete collection for relax , composed of armchair, 2 seater sofa, pouf, coffee table, gardener and brazier.

The structure is made of solid steel rod, with previous protection of zinc and powder coated painted.

The seat cushions are formed by a combination of comfort foams, with an inner waterproof cover of technical fabric and heat-sealed seams, and an outer sheath confection with Sunbrella LOPI acrylic fabric, in different colors. The collection is accompanied by additional decoration cushions.

MATERIALS / COLOURS

Colors



Green 6003

Sunbrella



Lopi Sand



Lopi Blush

Decorative cushions



Solids Pumkin



Solids Mint



Solids Blush



Heritage Leaf

SIZE	REF: 353	
WIDTH	148 CM	58"
DEPTH	83 CM	33"
HEIGHT	62 CM	24"
N.W.	27 KG	

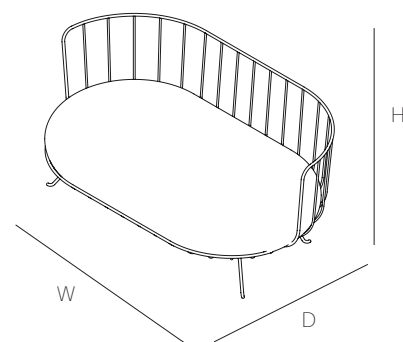

UN/BOX:	1/1
BOX SIZE:	152X87X68 CM
VOL:	0,90 M3
G.W.:	37 KG



DESIGN: STUDIO INMA BERMUDEZ



LOU

This is a complete collection for relax , composed of armchair, 2 seater sofa, pouf, coffee table, gardener and brazier.

The structure is made of solid steel rod, with previous protection of zinc and powder coated painted.

The seat cushions are formed by a combination of comfort foams, with an inner waterproof cover of technical fabric and heat-sealed seams, and an outer sheath confection with Sunbrella LOPI acrylic fabric, in different colors. The collection is accompanied by additional decoration cushions.

MATERIALS / COLOURS

Colors



Green 6003

Sunbrella



Lopi Sand



Lopi Blush

SIZE **REF: 354**

DIÁMETER	Ø88 CM	31"
HEIGHT	40 CM	16"
N.W.	15 KG	

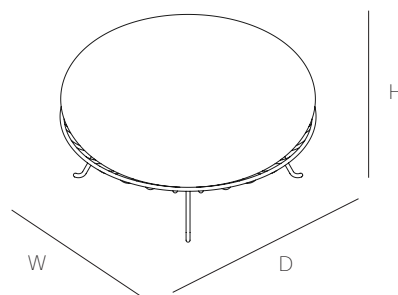

UN/BOX:	1/1
BOX SIZE:	84X84X44 CM
VOL:	0,31 M3
G.W.:	18 KG



calma.

marea





MAREA

A lounging collection

Solid but light, rigid but free, Marea (meaning “tide” in Spanish) is a seating collection defined by delicate balance and duality. Co-designed by Andreu Carulla and Joe Doucet, it embodies each designer’s particular design approach in a singular piece of furniture. Available both as a swing and as an armchair, the seat structure is in both cases suspended, giving it a gentle back-and-forth movement just like the tide of the ocean.

DESIGN: JOE DOUCET
& ANDREU CARULLA



DESIGN: ANDREU CARULLA & JOE DOUCET



MAREA

It is a collection for relax, composed of 2 pieces, a "loveseat" of natural Iroko wood structure without previous treatment, and a swing designed to be suspended.

They have in common the seat-backrest, of the same measures and patterns, based on technical fabric Batyline Eden in 2 colors, with inserts of fir wood to structure the shape and ergonomics.

SIZE	REF: 223	
WIDTH	116 CM	46"
DEPTH	78 CM	31"
HEIGHT	88 CM	35"
N.W.	14 KG	

MATERIALS / COLOURS

Iroko Wood



natural

Batyline Eden



0567 silver



0557 blue

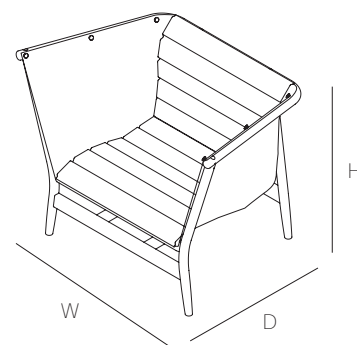

UN/BOX:	1/1
BOX SIZE:	120X82X92 CM
VOL:	0,90 M3
G.W.:	20 KG



calma.

marea swing



MAREA

A lounging collection

Solid but light, rigid but free, Marea (meaning “tide” in Spanish) is a seating collection defined by delicate balance and duality. Co-designed by Andreu Carulla and Joe Doucet, it embodies each designer’s particular design approach in a singular piece of furniture. Available both as a swing and as an armchair, the seat structure is in both cases suspended, giving it a gentle back-and-forth movement just like the tide of the ocean.

DESIGN: JOE DOUCET
& ANDREU CARULLA



DESIGN: ANDREU CARULLA & JOE DOUCET



MAREA SWING

A piece of furniture designed for relaxation, with a frame made from solid iroko wood, it is available in two versions: an arm chair and a hanging swing version.

They share a common seat and backrest of equal dimensions, made from technical Batyline Eden fabric in two colours, with slatted Douglas-fir inserts to structure it ergonomically.

MATERIALS / COLOURS

Iroko Wood



natural

Batyline Eden



0567 silver



0557 blue

SIZE	REF: 224	
WIDTH	120 CM	47"
DEPTH	82 CM	32"
HEIGHT	55 CM	22"
N.W.	5KG	

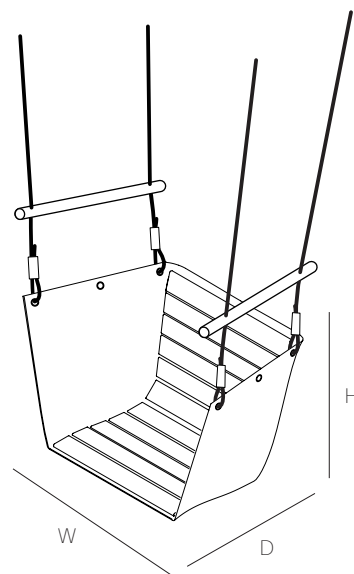

UN/BOX:	1/1
BOX SIZE:	100X42X35 CM
VOL:	0,15 M3
G.W.:	6 KG



calma.

maria



MARIA

Sra Maria, humble, rather simple, popular, Sra. Maria does not like to draw attention but always makes us look good. You can leave it at any corner where well and quietly will make what it has to do: sit well.

DESIGN:
ANDREU CARULLA



DESIGN: ANDREU CARULLA



ARMCHAIR

La estructura es de tubo cuadrado de aluminio de 22x22 mm en su parte perimetral, y de tubos circulares transversales de 18 mm para recibir el tejido con mas suavidad. Esta totalmente soldado y pintado texturizado con pintura en polvo al horno. El color de la estructura es el blanco.

Asiento y respaldo de una pieza de 49 cm de ancho en tejidos Sunbrella y Batyline, con insertos acolchados extraibles.

MATERIALS / COLOURS

Aluminium



11 white

Batyline Eden



0567 silver



0557 blue

SIZE	REF. 649	
WIDTH	60 CM	23"
DEPTH	55 CM	21"
HEIGHT	83 CM	32"
N.W.	8 KG	

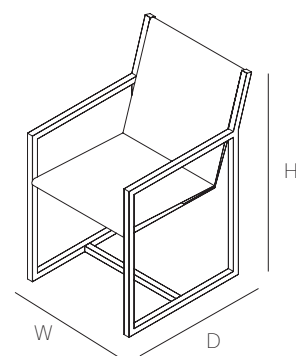

UN/BOX:	2/1	
BOX SIZE:	73X57X130 CM	
VOL:	0,541 M3	
G.W.:	18 KG	



calma.

nua



NUA

Have you ever imagined a simple dress could become your relax sofa? Nua is this. A simple dressed up naked aluminum frame.

DESIGN:
FERRAN SERRA



DESIGN: FERRAN SERRA

**REF. 935****LOUNGE CHAIR**

NUA takes a step forward with a new model of armchair, where the cushions have more prominence; they are incorporated in the arms. Although the aluminum structure remains the same, NUA acquires a more compact armchair look. The new finishes for this new version, the NUA Soirée, are the acrylics Sunbrella Natté Silver Gray and Dusk.

MATERIALS / COLOURS

Aluminium



11 white

Sunbrella natte



10083 dusk



10022 grey chiné

SIZE

REF. 933

WIDTH	82 CM	32"
DEPTH	71 CM	28"
HEIGHT	66 CM	26"
N.W.	9,8 KG	

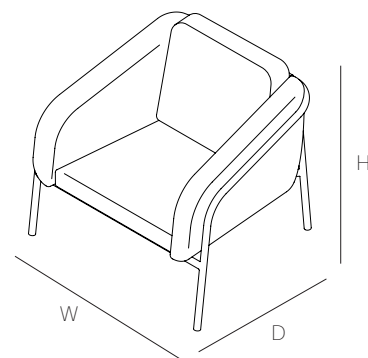

UN/BOX:	2/1
BOX SIZE:	90X83X72 CM
VOL:	0,537 M3
G.W.:	22,6 KG





OM UMBRELLA

Evoking the Mediterranean

Inspired by classic mediterranean canopies and umbrellas, Om brings a twist on a well-established product. Because of its innovative unfolding mechanism, the umbrella can be adapted to any need, wether it is fully, half or hardly open, providing different types of shade for every position.

DESIGN:
ANDREU CARULLA





DESIGN: ANDREU CARULLA



UMBRELLA

Mast and ribs made from extruded aluminium 6063, anodised in silver or black.

Mechanism rings made from machined solid aluminium 6063 with plastic gaskets and washers in every joint.

Open/close mechanism in stainless steel 304.

Fabric in polyester, Sunless 500

Two types of fabric configuration:

- Individual fabric panels inserted in the slots of the ribs (1)
- All-covering single-piece fabric fitted over the ribs (2)

MATERIALS/COLOURS

Anodised Aluminium STRUCTURE



13 black



12 silver

FABRIC Sunless 500



90 black



20 white



10 vainilla/grey

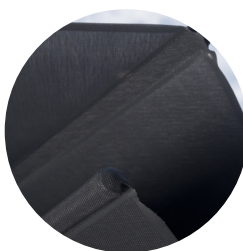

SIZE	REF. 993	
DIAMETER	300 CM	118"
HEIGHT	232 CM	91"
N.W.	18 kg	
UN/BOX:	1/1	
BOX SIZE:	237x43x13 cm	
VOL:	0,134 m ³	
G.W.:	27 kg	

SIZE	REF. 991	
DIAMETER	250 CM	98"
HEIGHT	232 CM	91"
N.W.	16 kg	
UN/BOX:	1/1	
BOX SIZE:	237x43x13 cm	
VOL:	0,134 m ³	
G.W.:	24 kg	

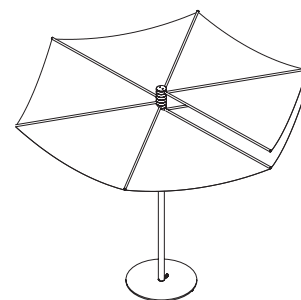

DESIGN: ANDREU CARULLA

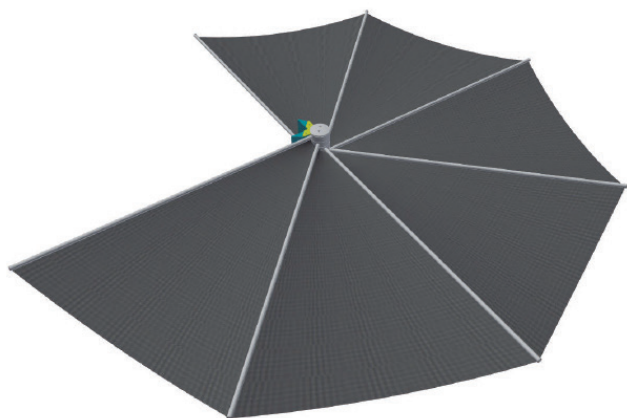

WALL-MOUNTED PARASOLS

Hub and ribs in extruded aluminium 6063 anodised in silver or black.

Mechanism rings made from machined solid aluminium 6063 with plastic gaskets and washers in every joint.

Open/close mechanism in stainless steel 304. Sandblasted in silver and sandblasted and lacquered in black

Wall fixing in sheet metal stainless steel 304. Fabric in polyester, Sunless 500.

MATERIALS/COLOURS

Anodised Aluminium STRUCTURE



13 black



12 silver

FABRIC Sunless 500



90 black



20 white



10 vainilla/grey

SIZE **REF. 973**

DIAMETER	300 CM	118"
N.W.		14 kg

UN/BOX: 1/1

BOX SIZE: 162x36x17 cm

VOL: 0,128 m³

G.W.: 17 kg



DESIGN: ANDREU CARULLA

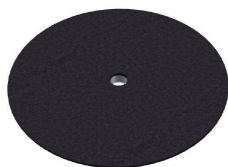

AUXILIARY TABLE

Tabletop in 10mm thick HPL, aluminium support adjustable in height.

MATERIALS / COLOURS

HPL



42 BLACK



41 WHITE

SIZE

REF. 982

DIAMETER	75 cm	28"
N.W.	7,7 kg	

UN/BOX: 1/1

BOX SIZE: 84x84x4 cm

VOL: 0,028 m³

G.W.: 8,7 kg

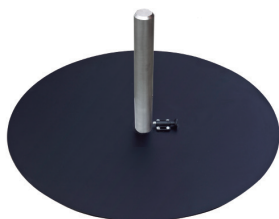

PARASOL BASE

Base in sheet metal stainless steel 304, zinc primed with aluminium and oven baked epoxy finish. Plastic stoppers as base feet. Mast in stainless steel 304

MATERIALS / COLOURS

ALUMINIUM ANODIZED



13 BLACK



12 SILVER



11 WHITE

SIZE

REF. 980

DIAMETER 70 cm 28"

HEIGHT 33 cm 13"

N.W. 50 kg

UN/BOX: 1/1

BOX SIZE: 80x75x6 cm

VOL: 0,036 m³

G.W.: 52 kg



FLOOR-MOUNTABLE PARASOL BASE

Base in sheet metal stainless steel 304, zinc primed with aluminium and oven baked epoxy finish. Designed to be fixed to the ground. Mast in stainless steel 304

MATERIALS / COLOURS

HPL



13 BLACK



12 SILVER

SIZE

REF. 981

DIAMETER 22 cm 9"

HEIGHT 33 cm 13"

N.W. 8 kg

UN/BOX: 1/1

BOX SIZE: 23x23x33 cm

VOL: 0,017 m³

G.W.: 10 kg





TEN COLLECTION

The compact and straight lines of its frame combine with the curvy and wavy lines of the wood-grain. Ten is the essence and warmth of nature.

DESIGN:
RICARD VICENS



DESIGN: RICARD VICENS



MESAS COMEDOR

Estructura de marco de aluminio sobre patas desmontables también de aluminio, todo ello acabado con pintura en polvo al horno.

Encimera de componente Dekton, de 8 mm de espesor

MATERIALS / COLOURS

Aluminium Frame

HPL Top



11 white



14 mocca



13 black



AU aura



ED edora



TR trilium

SIZE	REF. 925	
WIDTH	90 CM	35"
DEPTH	240 CM	94"
HEIGHT	74 CM	29"
N.W.	65 KG	

UN/BOX:	1/1	
BOX SIZE:	250X100X12 CM	
VOL:	0,300 M3	
G.W.:	70 KG	

SIZE	REF. 924	
WIDTH	90 CM	35"
DEPTH	200 CM	94"
HEIGHT	74 CM	29"
N.W.	51 KG	

UN/BOX:	1/1	
BOX SIZE:	210X100X12 CM	
VOL:	0,252 M3	
G.W.:	56 KG	

SIZE	REF. 923	
WIDTH	90 CM	35"
DEPTH	90 CM	35"
HEIGHT	74 CM	29"
N.W.	28 KG	

UN/BOX:	1/1	
BOX SIZE:	100X100X12 CM	
VOL:	0,120 M3	
G.W.:	30 KG	





SENYORA PEPA LOUNGE ARMCHAIR

*An origami-like seating system
that is incredibly flexible.*

Different material and frame combinations define the Senyora Pepa seating collection. The covers can be removed and changed in an instant.

Each with its own distinctive personality, they can easily feel at home indoors and outdoors, enjoying the Mediterranean sun or keeping warm by a wood-burning stove.

DESIGN:
ANDREU CARULLA



DESIGN: ANDREU CARULLA



STACKABLE LOUNGE CHAIR

The structure is formed by 12mm steel rods that are bent to meet tangentially. Carefully spot-welded, this minimises the amount of joints. Galvanised and then powder coated in the oven, this gives it an anti-oxidant protection.

Where the structure meets the ground, round corners are protected with nylon feet.

The seat and backrest are both 65cm wide in Sunbrella fabric with removable padding. Cushions in laminated Sunbrella fabric with heat-sealed seams.

MATERIALS / COLOURS

Steel Frame



11 white



14 mocca

Sunbrella Chartres



F025 carbon



F028 dove

Cushions: Sunbrella Chartres



F028 dove



F026 shale

SIZE	REF. 565	
WIDTH	73 CM	28"
DEPTH	75 CM	29"
HEIGHT	66 CM	26"
N.W.	12,5 KG	

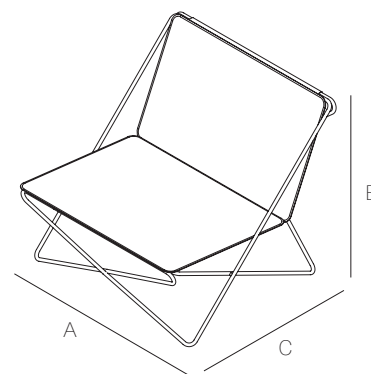

UN/BOX:	2/1
BOX SIZE:	78X81X77 CM
VOL:	0,483 M3
G.W.:	27 KG



DESIGN: ANDREU CARULLA



STACKABLE CHAIR

The structures are made of 12 mm diameter stainless steel tube that connect straight sections with curved sections, joined by careful welding to minimize the joints. The finish is given with the powder paint in the oven, after treatment of antioxidant protection based on galvanized.

The feet are formed by spokes, all equal, which allow the coupling of nylon stops with the shape of the radius of the tube and thus avoid direct contact of the metal with the pavement.

Seat and back of a 43 cm wide piece in Sunbrella fabrics, with removable padded inserts.

MATERIALS / COLOURS

Steel Frame



11 white



14 mocca

Sunbrella Chartres



F025 carbon



F028 dove

Cushions: Sunbrella Chartres



F028 dove



F026 shale

SIZE	REF. 543	
WIDTH	73 CM	28"
DEPTH	75 CM	29"
HEIGHT	66 CM	26"
N.W.	12,5 KG	

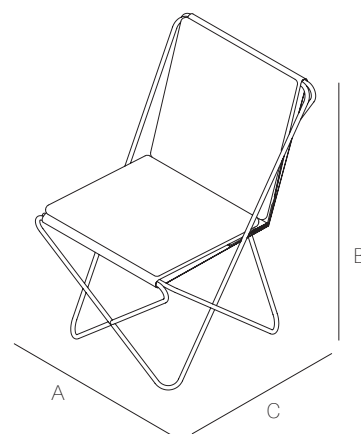

UN/BOX:	2/1
BOX SIZE:	78X81X77 CM
VOL:	0,483 M3
G.W.:	27 KG



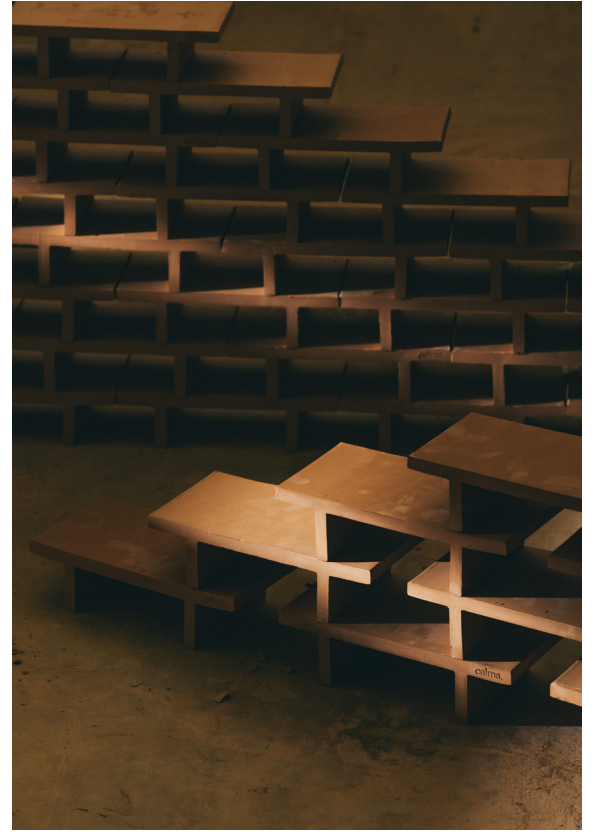

TRAMA

A reinterpretation of the typical Spanish “gelosia”, a modular ceramic outdoor architectural feature.

Trama is unique as it is the first in its kind not to produce double-wall thicknesses when built-up. It also allows varying levels of transparency depending on the way the individual pieces are configured.

DESIGN:
ANDREU CARULLA

DESIGN: ANDREU CARULLA

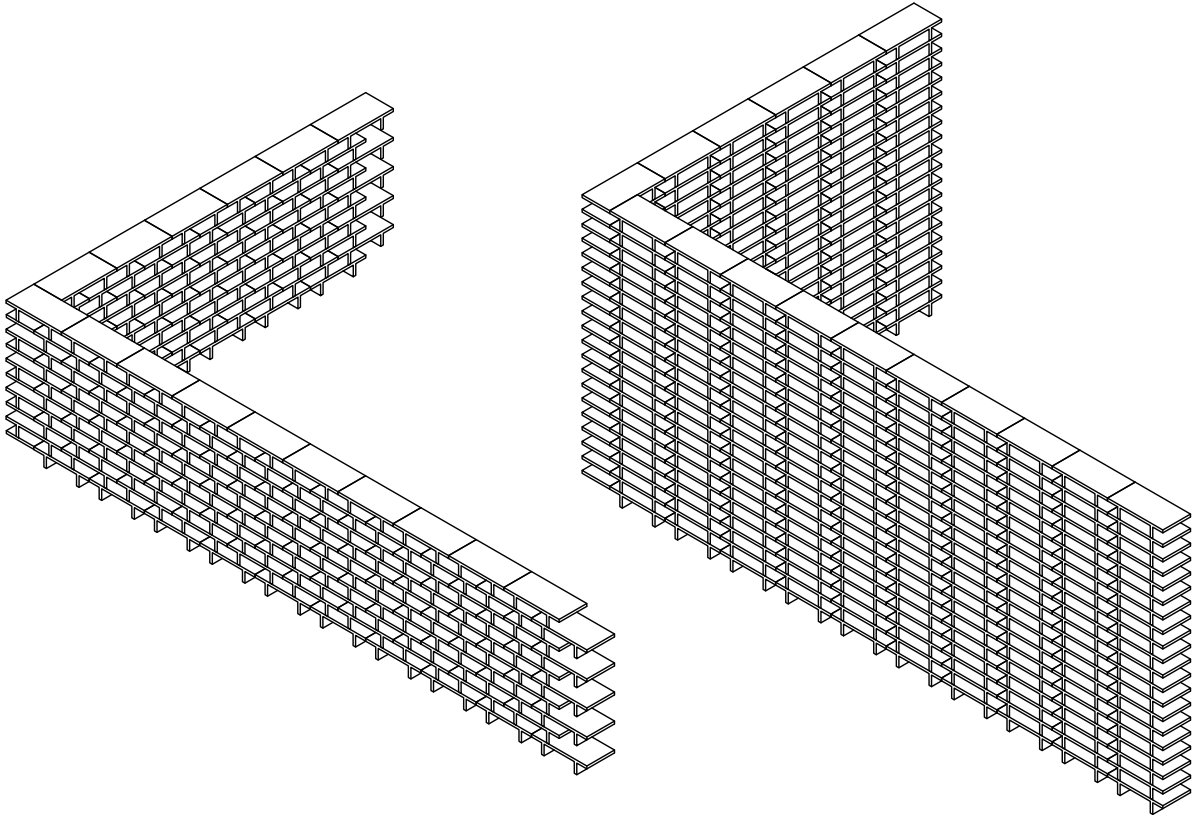

TRAMA

Natural ceramic accessory, of small sizes to be mounted in different positions to offer lattices and transparencies of different sensations and aspects.

MATERIALS / COLOURS

Ceramics



SIZE	REF. 258	
WIDTH	26 CM	10"
DEPTH	10 CM	4"
HEIGHT	6 CM	2"

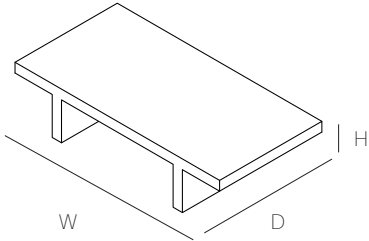



TRAMA

A reinterpretation of the typical Spanish “gelosia”, a modular ceramic outdoor architectural feature.

Malla is able to be supported by structural rods and offers the option to be hung like a ceramic curtain.

DESIGN:
ANDREU CARULLA

DESIGN: ANDREU CARULLA

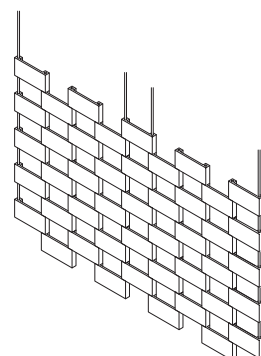
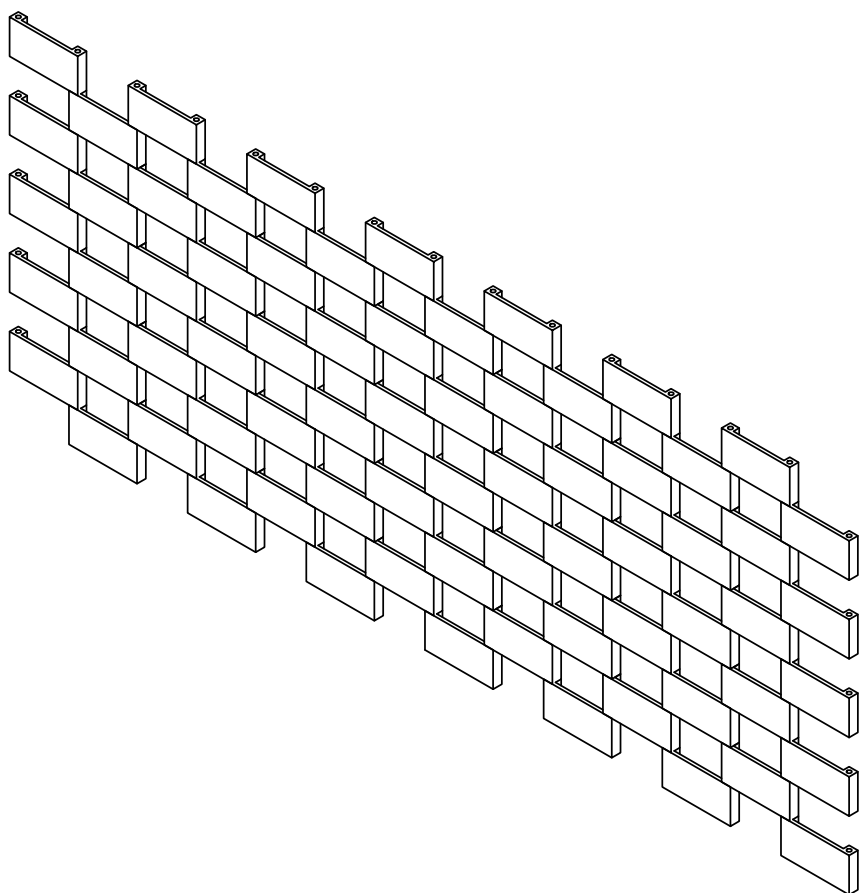
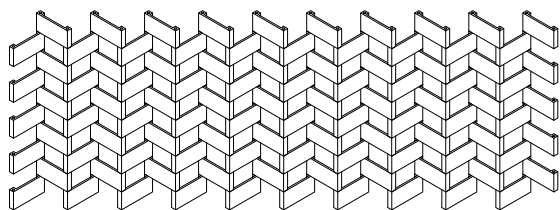
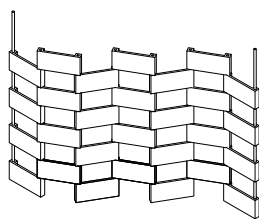

MALLA

Natural ceramic accessory, of small sizes to be mounted in different positions to offer lattices and transparencies of different sensations and aspects.

MATERIALS / COLOURS

Ceramics



SIZE	REF. 259	
WIDTH	26 CM	10"
DEPTH	10 CM	4"
HEIGHT	6 CM	1,5"

