

indoor

# Nautica Swing chair / columpio



reddot award 2014  
winner

MUT Design, 2012

T060

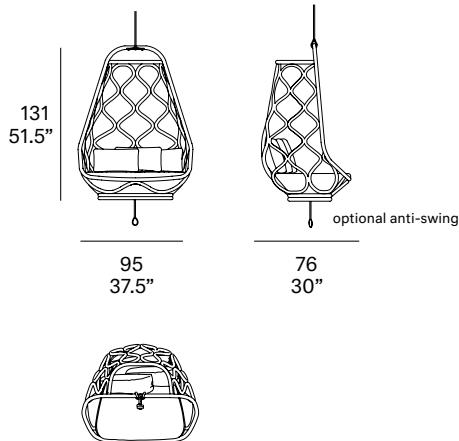

Swing chair with structure made of peeled and tinted natural rattan of 1.33" diameter. Backrest manufactured in peeled and tinted natural rattan of 0.94" diameter. Finished with a three step water-based coating (dye, base coat and top coat) highly resistant to solar radiation thanks to UV filters. Upholstered cushion with possibility of customization through a wide variety of high performance technical fabrics. 3 loose cushions 19.75"x 12.5" included. Polyester rope with 0.55" of section to hang the swing chair included. Optional anti-swing (braided polyester rope + carabiner).

Columpio con estructura en rattan natural pelado y tintado de 34 mm de calibre. Respaldo fabricado en rattan natural pelado y tintado de 24 mm de calibre. Acabado con recubrimiento en tres fases (tinte, fondo y acabado) con filtros UV que lo hacen altamente resistente a la radiación solar. Los acabados utilizados son en base al agua. Cojines tapizados con posibilidad de personalización mediante una amplia variedad de tejidos técnicos de altas prestaciones de uso. 3 cojines decorativos de 50x32 cm incluidos. Cuerda de poliéster de 14 mm de sección necesaria para colgar el columpio incluida.

## Shipment details

Qty	1 swing chair (1 box)
Volume	1,04 m <sup>3</sup> / 36.7 ft <sup>3</sup>
Gross weight	19 kg / 41.9 lb
Net weight	14 kg / 30.9 lb
Box dimensions (approx.)	98 x 79 x 134 cm 38.5" x 31" x 52.75"
Item dimensions (width x depth x height)	95 x 76 x 131 cm 37.5" x 30" x 51.5"
COM	seat cushion: 1,8 m / 1.9 yd (1, 40 - 1,50 m / 54"-59") loose cushion: 1,5 m / 1.6 yd

## Certifications

EN 581-1:2006  
EN 581-2:2016

expormim

Expormim S.A.  
Pol. Ind. Jaime I  
46640 Moixent (Valencia) Spain  
+34 962 295 144/5  
export@expormim.com  
www.expormim.com

Expormim USA LLC  
(212) 204-8572  
usa@expormim.com  
www.expormim.com

1/6

**Rattan**

**Tinted**



R10 natural



R03 noce



R06 verde oliva



R08 azzurro



R07 mogano



R24 cinder purple



R23 french grey



R05 grigio



R09 nero

**Lacquered**



R02 bianco



R22 clay



R17 forest green



R16 navy blue



R14 japanese red



indoor

Cushions / confección

group 1 - natté Sunbrella®



natté white

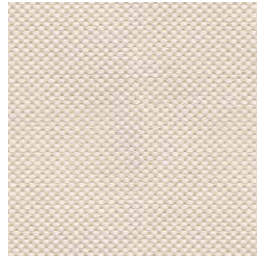

natté canvas



natté taupe chalk

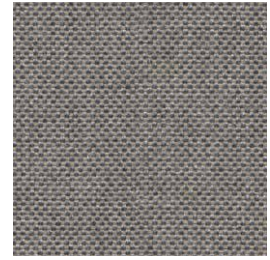

natté carbon beige



natté dark taupe



natté carbon sky



natté amber

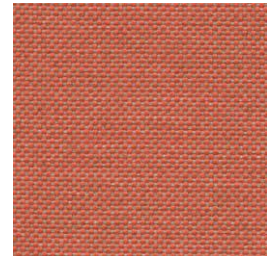

natté flamingo

group 1 - dolce Crevin®



dolce 07



dolce 16

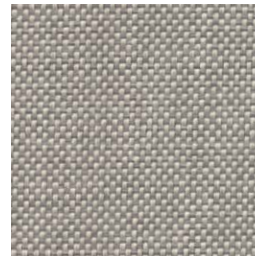

dolce 75



dolce 53

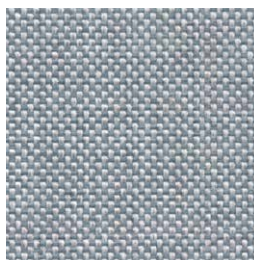

dolce 43



dolce 24



dolce 30

indoor

Cushions / confección

group 1 - valencia™ faux leather



valencia 1049



valencia 0020

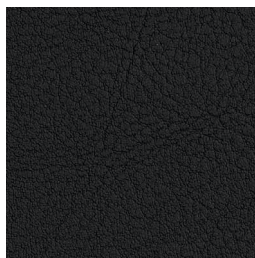

valencia 9035

Cushions / confección

group 2 - ito Crevin®



ito 05

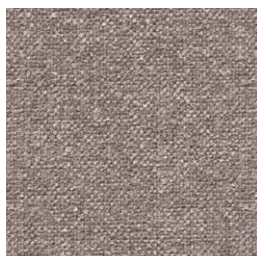

ito 18



ito 12



ito 71



ito 21



ito 20



ito 38



ito 45

group 2 - sacco Crevin®



sacco 02



sacco 05



sacco 11

indoor

Cushions / confección

group 3 - ascendent Carlucci®



ascendent 090



ascendent 070



ascendent 071



ascendent 030



ascendent 093



ascendent 022



ascendent 040

group 3 - elmosoft Elmo® leather



elmosoft 22024



elmosoft 93129

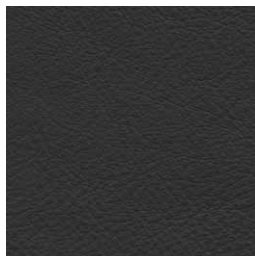

elmosoft 99999

indoor

Decorative cushions

Sunbrella®



ikebana uyuni J369



ikebana safari J332

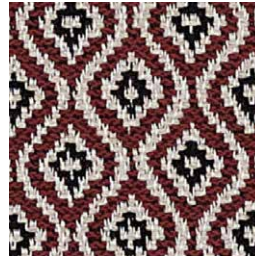

komo tawny J345

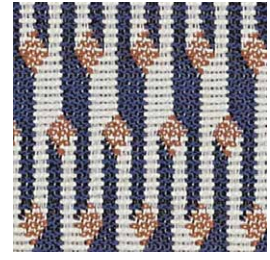

marquetry mistral J384



marquetry shamal J383