

 **angel cerdá**

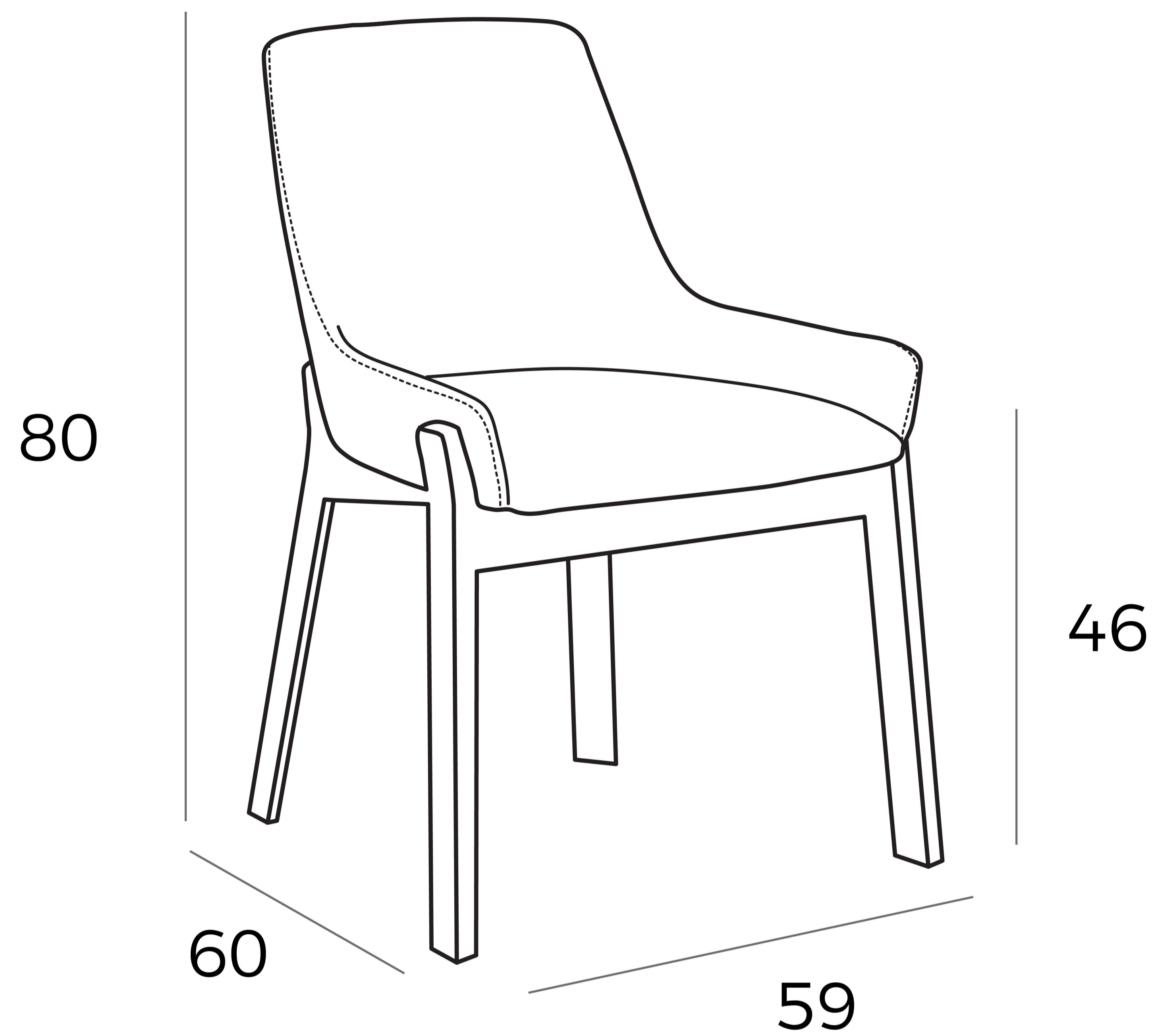

**PACK  
2**

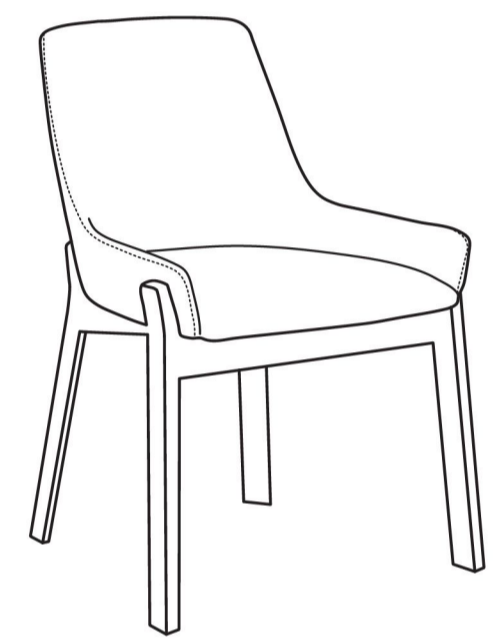

59 x 60 x 80 cm.  
16,5 kg.

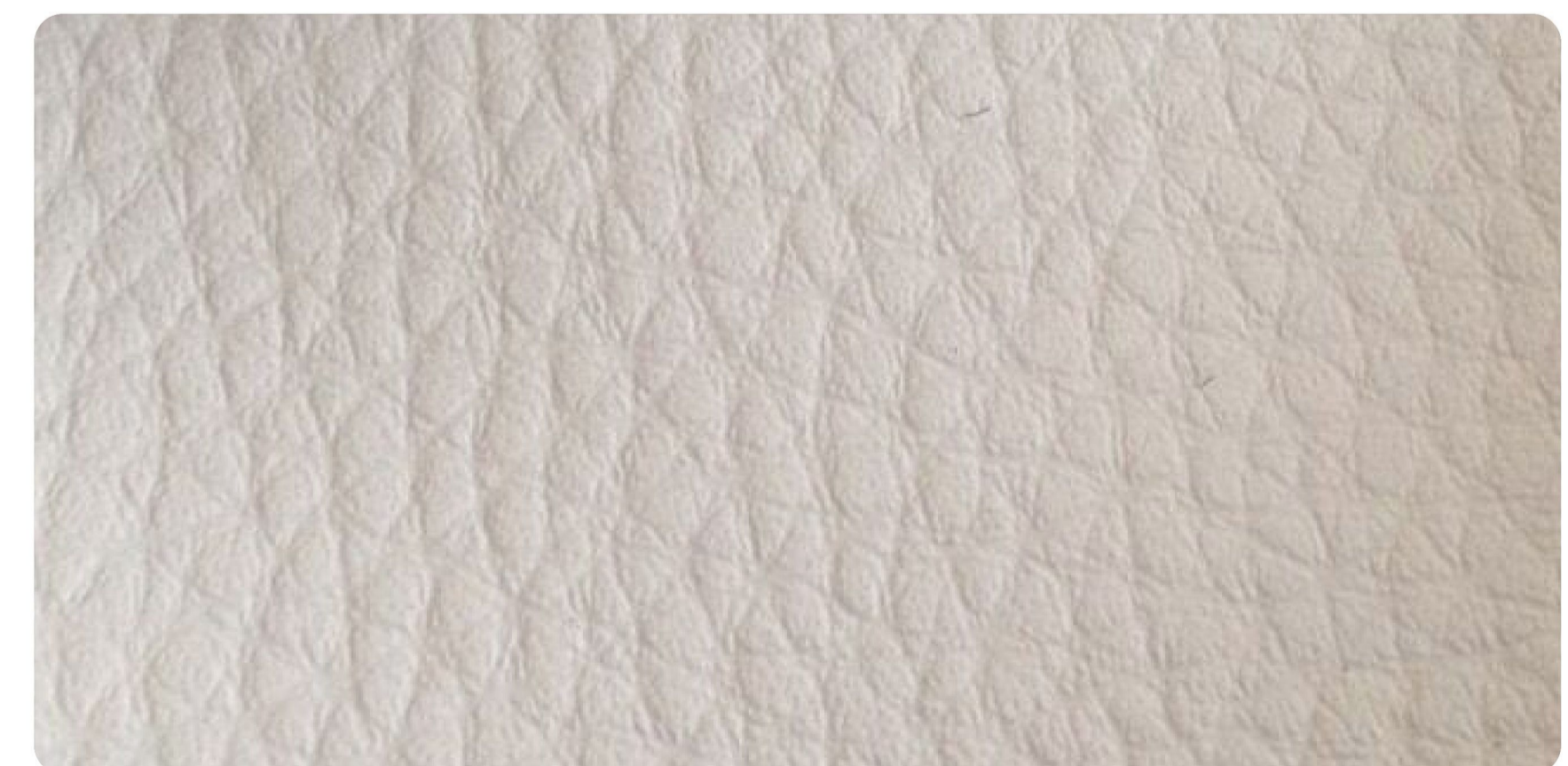
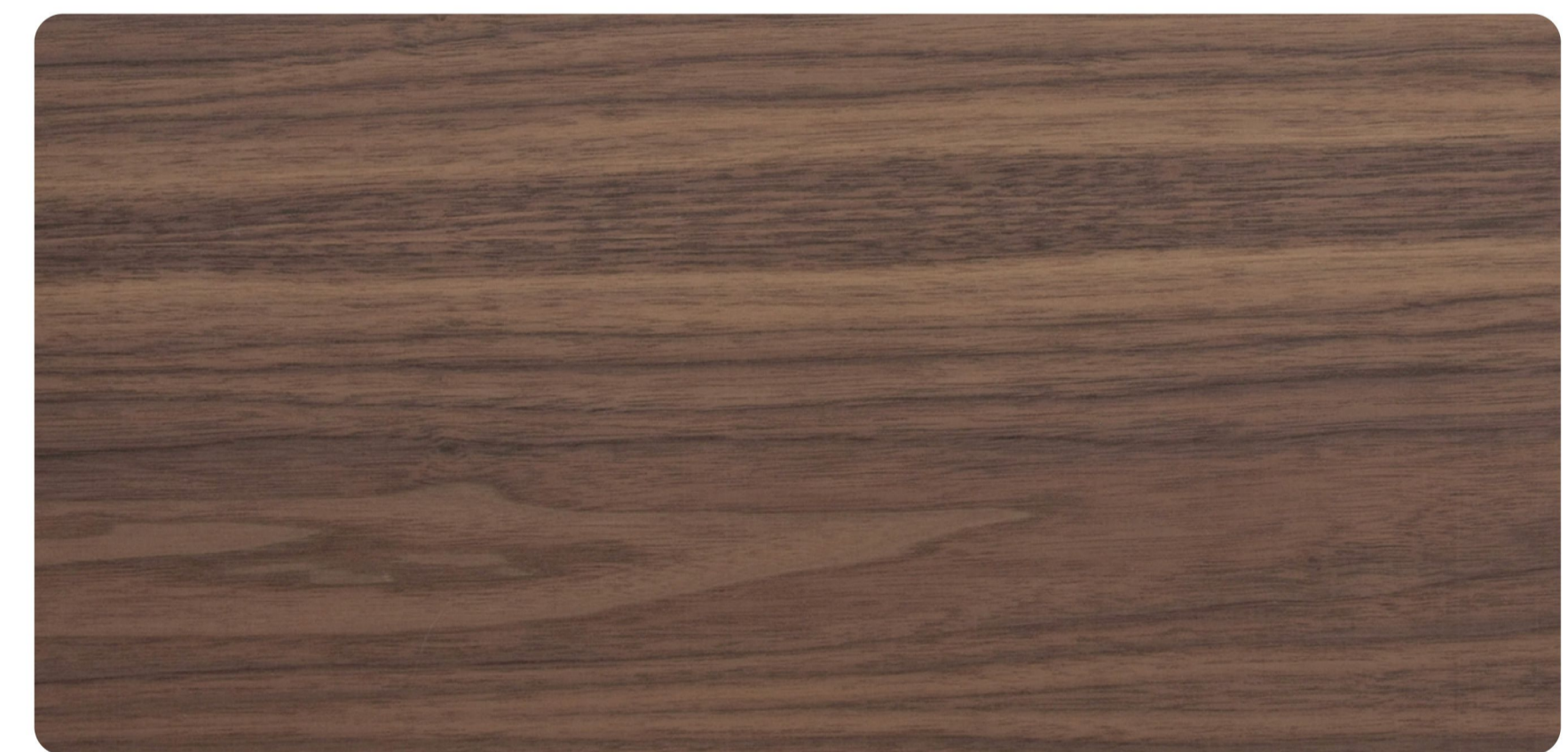

 68 x 66 x 50 cm.  34 kg.