

outdoor

Nautica outdoor Swing chair with base / columpio con base

MUT Design 2013

C361



Swing chair structure made of high resistance aluminum tube finished in textured epoxy paint. Expanded polyurethane seat cushion with removable waterproof and fireproof cover made of polyester with special anti-mould and anti-bacterial treatment. 3 loose cushions 19.75"x19.75" included. Braided polyester rope is provided to hang the swing chair. Optional anti-swing (braided polyester rope + carabiner). Base made of high resistance aluminum tube finished with polyester powder.

Estructura del columpio fabricada en tubo de aluminio de alta resistencia, con acabado en pintura epoxi texturada. Cojín de asiento en poliuretano expandido con funda hidrófuga e ignífuga fabricada en poliéster con un tratamiento especial antifúngico y antibacteriano. 3 cojines de corativos de 50x32 cm incluidos. Cuerda de poliéster suministrada, necesaria para el anclaje del columpio a la base. Anti-swing opcional (cuerda de poliéster + mosquetón). Base fabricada en tubo de aluminio de alta resistencia, con acabado en pintura de polvo de poliéster.

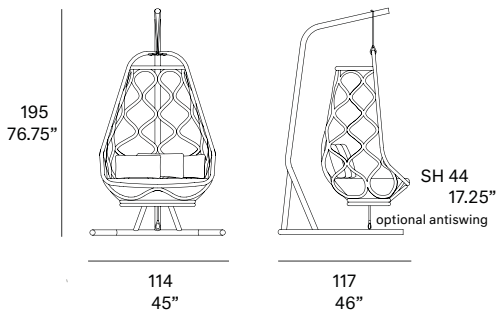

Shipment details

Qty	1 swing chair with base (1 box)
Volume	3,3 m3 / 116.5 ft3
Gross weight	56 kg / 123 lb
Net weight	40 kg / 88 lb

Item dimensions (width x depth x height)	114 x 117 x 195 cm 45" x 46" x 76.75"
COM (1, 40 - 1,50 m / 54"-59")	seat cushion: 1,8 m / 2 yd loose cushion: 1,5 m / 1.7 yd

Certifications

UNE EN 581-1:2006
UNE EN 581-2:2016

Awards



reddot award 2017
winner

expormim

Expormim S.A.
Pol. Ind. Jaime I
46640 Moixent (Valencia) Spain
+34 962 295 144/5
export@expormim.com
www.expormim.com

Expormim USA LLC
(212) 204-8572
usa@expormim.com
www.expormim.com

1/7

frame / estructura

metallic finishes / metales



600 white
antique textured



102 FT light grey
fine textured



111 FT graphite
fine textured

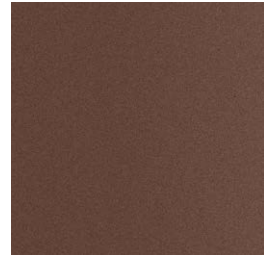

108 FT oxide
fine textured



109 FT champagne
fine textured



110 FT bronze
fine textured



113 FT sage
fine textured

base

metallic finishes / metales



600 white
antique textured



111 FT graphite
fine textured

outdoor

Cushions / confección

group 11 - natté Sunbrella®



natté white



natté canvas



natté taupe chalk

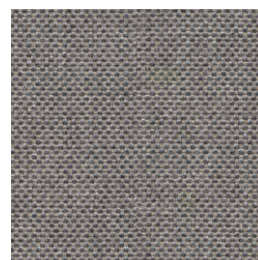

natté carbon beige



natté dark taupe

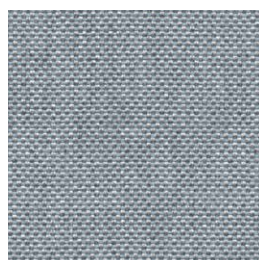

natté frosty chiné



natté carbon sky

outdoor

Cushions / confección

group 12 - dolce Crevin®



dolce 07



dolce 16



dolce 80

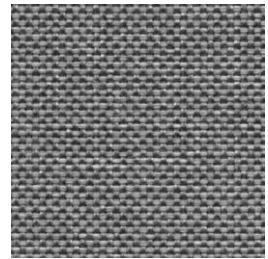

dolce 51



dolce 53

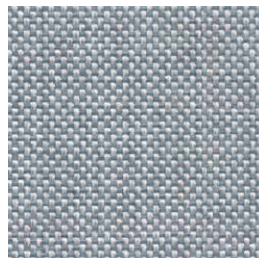

dolce 43

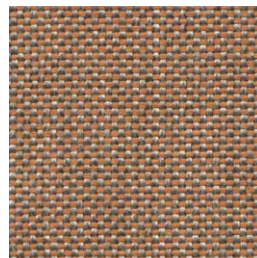

dolce 24



dolce 30

group 12 - strada Crevin®

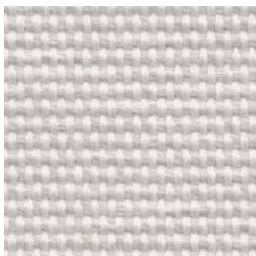

strada 07

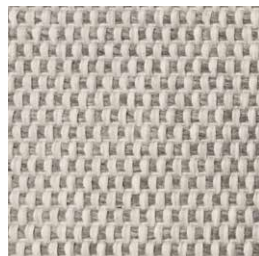

strada 75

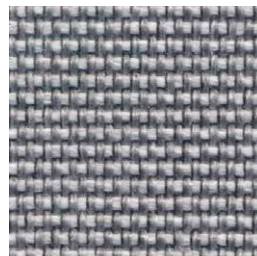

strada 51



strada 83

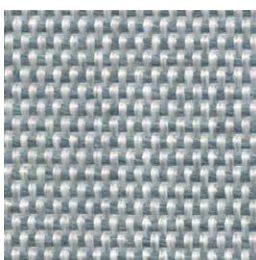

strada 43

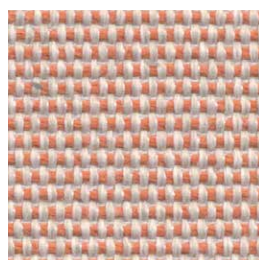

strada 29



strada 32

outdoor

Cushions / confección

group 12 - silvertex™

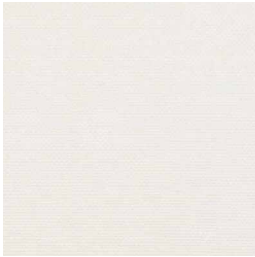

silvertex ice

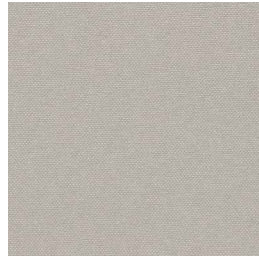

silvertex macadamia

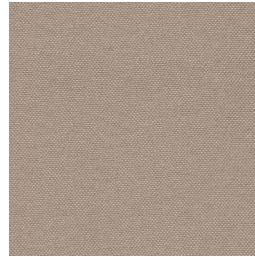

silvertex sandstone

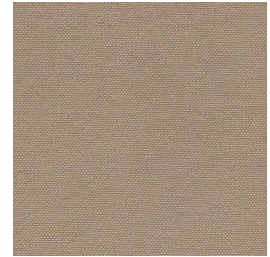

silvertex taupe

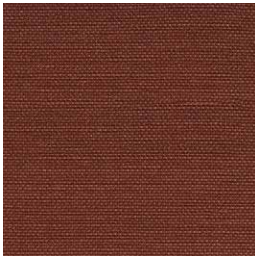

silvertex umber

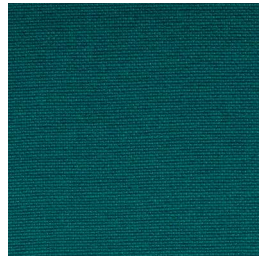

silvertex teal



silvertex citrus

outdoor

Cushions / confección

group 13 - heritage Sunbrella®



heritage papyrus



heritage ash

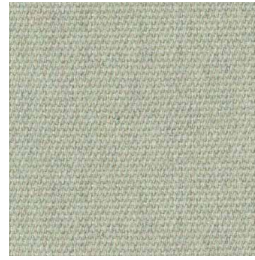

heritage moss

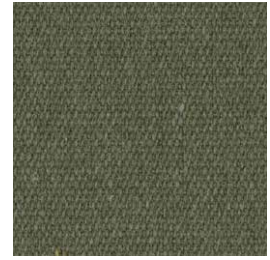

heritage leaf



heritage rust



heritage scarlet

group 13 - sling Sunbrella®

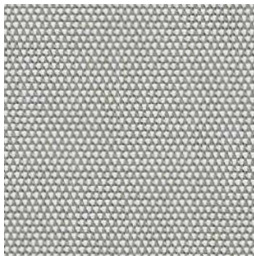

sling sailing seagull

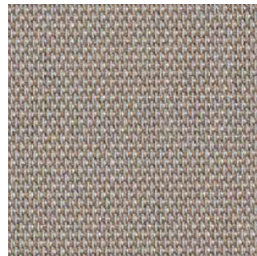

sling sailing space

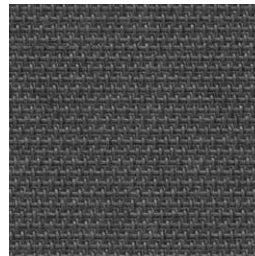

sling logan graphite

outdoor

Cushions / confección

group 13 - bora bora Crevin®



bora bora 99



bora bora 07



bora bora 08



bora bora 11



bora bora 42



bora bora 47