

Dining table Ø135
by Doshi Levien

kettal

Dining table

Ø135

Designer
Doshi Levien

Collection
Cala

Reference
KS2701400

1/3

Functionality is a key aspect of the Cala Dining Table's design. Its generous tabletop provides ample space for dining, allowing individuals to gather comfortably and enjoy meals together. The table's height and dimensions are carefully considered to promote a comfortable dining experience for users. Its versatile design enables it to seamlessly complement various interior styles, ranging from contemporary to eclectic. Its clean lines and choice of materials make it a striking centerpiece that enhances the overall atmosphere of any dining area.

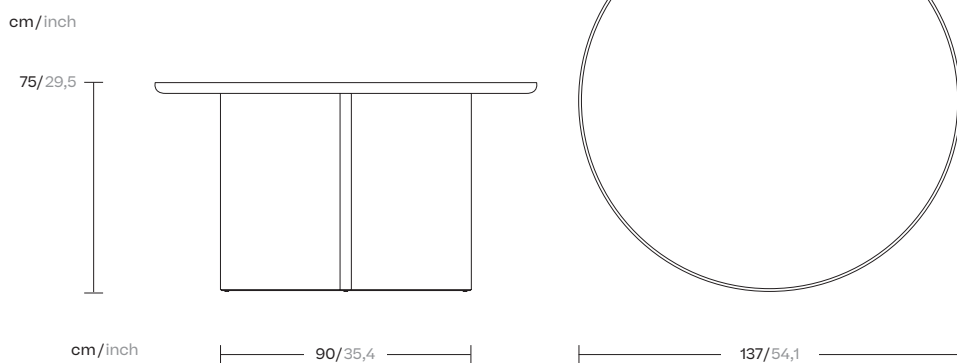

kettal

Dining table

Ø135

Designer
Doshi Levien

Collection
Cala

Reference
KS2701400

2/3

Materials

Teak
Teak A-Grade, Eco Friendly
Oeko-Tek

Marble
Antioxy, Mold resistant, Easy
Clean, Resist U.V., X-Temperature

Aluminium
Antioxy, Heavy Load, Resistant
En-1421, Kettalize-It, Anti-
Scratch, Easy Clean,
Flame Retardant M1, Eco Friendly
Ecoembes Recycling Process

Table Top / Base / Ring Colour

Terrain Coatings



Slate Stone
01C

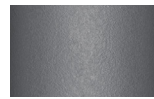

Mysty Smoke
02C



Ash
03C



Bone
04C

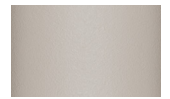

Tuff
05C



Wet Stone
06C



Sand Dune
07C



Dry Clay
08C



Arabica
09C



Sepia
19C



Rose Canyon
16C



Blossom
20C



Ruby Dust
18C



Sunset Glow
17C



Terrarosa
15C



Terracota
14C



Amber
13C



Ginger Root
12C



Desert Storm
11C



African Savannah
10C



Spring Meadow
28C

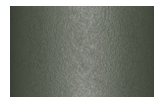

Kombu
29C



Forest Stream
27C



Sea Moss
26C



Glacier Ice
25C



Polar Sky
24C



Nightfall
23C



Indigo
22C



Wild Lupin
21C



Galena
33C



Bronze
30C



Corten
31C

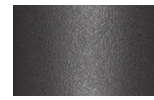

Manganese
32C

Dining table

Ø135

Designer
Doshi Levien

Collection
Cala

Reference
KS2701400

3/3

Other Characteristics

 Adjustable legs

Maintenance

Aluminium

Protect surfaces with barrier elements like film, paper, and peelable lacquers before placement and handling. If accidental contamination or splashing of strong alkalis or acids occurs, wash the affected area with a large amount of clean water, especially cut-outs or holes and cavities.

Teak

We recommend treating the wood with sealer every three months, or more frequently in the case of hotel and catering establishments. To restore the teak to its original appearance, sand the entire surface and apply the sealer.

Marble

Clean only with a soft cloth, warm water and pH neutral detergent. Do not use: acids, ammonia, abrasive powders, window cleaners and so on. Any substance with an acid pH will damage marble: lemon juice, wine, etc. Marble is treated with a waterproof sealant to protect it from damp and stains (as long as they are cleaned immediately); however, this sealant naturally wears off over time. We recommend treating the marble with sealant every three months, more frequently in the case of hotel and catering establishments.

Table Top Colour Options

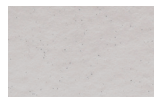

Dolomite
373

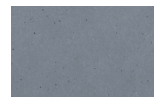

Indian Sapphire
371



Montana
377

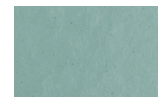

Erinite
376



Smoky Quartz
370



Jasper
375



Obsidian
372

Table Top Colour Options



Teak
904



Marble
079

Table Base Colour Options



Teak
904