

ILUMINACIÓN DECORATIVA | ESPACIOS PÚBLICOS | AMBIENTES PRIVADOS |
HOME&CONTRACT | LUZ | PROYECTOS ILUMINACIÓN | LIGHTING PROJECTS |
MADE IN SPAIN | SINCE 1942 | ILUMINACIÓN DECORATIVA | ESPACIOS PÚBLICOS
| AMBIENTES PRIVADOS | HOME & CONTRACT | LUZ | PROYECTOS ILUMINACIÓN
| LIGHTING PROJECTS | MADE IN SPAIN | SINCE 1942 | ILUMINACIÓN DECORATI-
VA | ESPACIOS PÚBLICOS | AMBIENTES PRIVADOS | HOME & CONTRACT | LUZ
| PROYECTOS ILUMINACIÓN | LIGHTING PROJECTS | MADE IN SPAIN | SINCE 1942
| ILUMINACIÓN DECORATIVA | ESPACIOS PÚBLICOS | AMBIENTES PRIVADOS |
HOME & CONTRACT | LUZ | **PROYECTOS ILUMINACIÓN** | LIGHTING PROJECTS |
MADE IN SPAIN | SINCE 1942 | ILUMINACIÓN DECORATIVA | ESPACIOS PÚBLICOS
| AMBIENTES PRIVADOS | HOME & CONTRACT | LUZ | PROYECTOS ILUMINACIÓN
| LIGHTING PROJECTS | MADE IN SPAIN | SINCE 1942 | ILUMINACIÓN DECORATI-
VA | ESPACIOS PÚBLICOS | AMBIENTES PRIVADOS | HOME & CONTRACT | LUZ
| PROYECTOS ILUMINACIÓN | LIGHTING PROJECTS | **MADE IN SPAIN** | SINCE 1942
| ILUMINACIÓN DECORATIVA | ESPACIOS PÚBLICOS | AMBIENTES PRIVADOS |
HOME & CONTRACT | LUZ | PROYECTOS ILUMINACIÓN | LIGHTING PROJECTS |
MADE IN SPAIN | SINCE 1942 | ILUMINACIÓN DECORATIVA | ESPACIOS PÚBLICOS
| AMBIENTES PRIVADOS | HOME & CONTRACT | LUZ | PROYECTOS ILUMINACIÓN
| LIGHTING PROJECTS | MADE IN SPAIN | SINCE 1942 | ILUMINACIÓN DECORATI-
VA | ESPACIOS PÚBLICOS | AMBIENTES PRIVADOS | HOME & CONTRACT | LUZ |
PROYECTOS ILUMINACIÓN | LIGHTING PROJECTS | MADE IN SPAIN | SINCE 1942
| ILUMINACIÓN DECORATIVA | ESPACIOS PÚBLICOS | **AMBIENTES PRIVADOS** |
HOME & CONTRACT | LUZ | PROYECTOS ILUMINACIÓN | LIGHTING PROJECTS |
MADE IN SPAIN | SINCE 1942 | ILUMINACIÓN DECORATIVA | ESPACIOS PÚBLICOS
| AMBIENTES PRIVADOS | HOME & CONTRACT | LUZ | PROYECTOS ILUMINACIÓN
| LIGHTING PROJECTS | MADE IN SPAIN | **SINCE 1942** | ILUMINACIÓN DECORATI-
VA | ESPACIOS PÚBLICOS | AMBIENTES PRIVADOS | HOME & CONTRACT | LUZ |
PROYECTOS ILUMINACIÓN | LIGHTING PROJECTS | MADE IN SPAIN | SINCE 1942
| ILUMINACIÓN DECORATIVA | ESPACIOS PÚBLICOS | AMBIENTES PRIVADOS |
HOME & CONTRACT | LUZ | PROYECTOS ILUMINACIÓN | LIGHTING PROJECTS |

MADE
SPAIN

since 1942



massmi.com

INDUSTRIAS MASSMI S.L.
Villa de Madrid, 48 | 46988
Pol. Ind. Fuente del Jarro
Patema. Valencia. España.
T. (+34) 961 321 416
F. (+34) 961 321 898
massmi@massmi.com

Vintage

2

LAFFIE / 8

Lámpara de suspensión
Ceiling lamp



SAVOY / 10

Lámpara de suspensión
Ceiling lamp



CROSBY / 12

Lámpara suspensión / pared
Ceiling lamp / wall

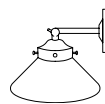

LONDON / 14

Lámpara de mesa / pared
Table lamp / wall

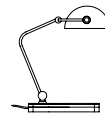

POIRET / 16

Lámpara de mesa / pared
Table lamp / wall

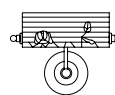

LUIGI / 18

Lámpara de suspensión /
mesa / pared
Ceiling lamp / table / wall

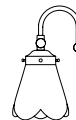

NOVEAU / TOURNON / 20

Lámparas de suspensión /
mesa / pared
Ceiling lamp / table / wall

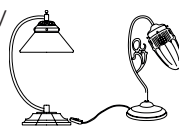

CANDEL / HOLLAND / 22

Lámpara de suspensión /
mesa / pared
Ceiling lamp / table / wall

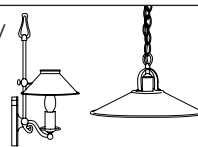

CLUB / CLUB shade / 24 / 34

Lámpara de suspensión /
mesa / pared / suelo
*Ceiling lamp / table /
wall / floor*

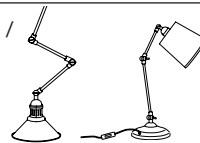

LABOHÈME / 36

Lámpara de suspensión /
mesa / pared / suelo
*Ceiling lamp / table /
wall / floor*

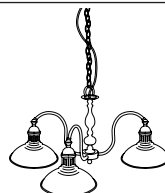

JABEL / TALIS / 38

Lámpara de suspensión
/ mesa / pared / suelo
*Ceiling lamp / table /
wall / floor*

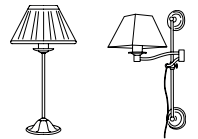

LARA / 40

Lámpara de suspensión
/ plafón
Ceiling lamp / plafond



LOLA / 42

Lámpara de suspensión
Ceiling lamp

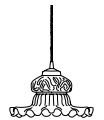

MOON / 44

Lámpara de suspensión
Ceiling lamp

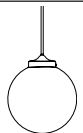

LITE / 46

Lámpara de suspensión
/ mesa
Ceiling lamp / table

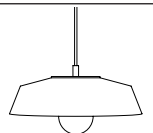

SLIM / 48

Lámpara de suspensión
Ceiling lamp

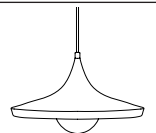

GARLAND / 50

Lámpara de suspensión /
mesa
Ceiling lamp / table

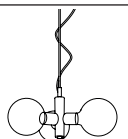

BULB / 52

Lámpara de suspensión /
mesa
Ceiling lamp / table

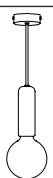

Core

NAAF / 56

Lámpara de suspensión / mesa
Ceiling lamp / table



INFINITO / IN 58 / 94 / 95

Lámpara de suspensión
plafón / mesa / suelo
*Ceiling lamp / table /
plafond / floor*

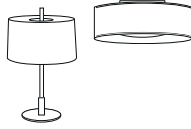

INFINITO 45° / IN pleat / IN elect. 60 / 96

Lámpara de suspensión
plafón / mesa / suelo
*Ceiling lamp / table / floor
/ plafond*

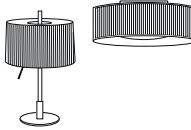

IN iris / IN gold / 62 / 80

Lámparas de
suspensión / plafón
Ceiling lamp / plafond

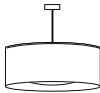

LOULU / 64

Lámpara de mesa / suelo
Table lamp / floor



HANG OUT / 66

Lámpara de suspensión
Ceiling lamp



FUSTA / 68

Lámpara de suelo
Floor lamp



ELEGANCE / 70

Lámpara de suspensión /
mesa / suelo
Ceiling lamp / table / floor

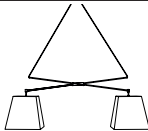

BLUR / 72

Lámpara de suspensión / suelo
Ceiling lamp / floor

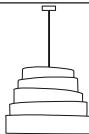

TO BE / 74

Lámpara de suspensión
Ceiling lamp



BORROCO / 76

Lámpara de suspensión /
mesa / suelo
Ceiling lamp / table / floor

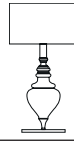

KAIRÓS / 82

Lámpara de suspensión /
mesa / suelo
Ceiling lamp / table / floor



ABBY / ORIGAMI / 84

Lámpara de suspensión
/ mesa / suelo / pared
plafón
*Ceiling lamp / table / floor
/ wall / plafond*

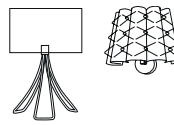

INFINITO nordic / 86

Lámpara de suspensión
/ mesa
Ceiling lamp / table

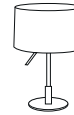

VOLUM / 88

Lámpara plafón
Plafond lamp



VOLUM basic / GATE / 90

Lámparas de suspensión
/ plafón
Ceiling lamp / plafond

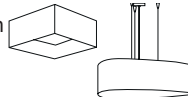

SIXTIE / 92

Lámpara de mesa / suelo
Table lamp / floor



LOBBY / 98

Lámpara de mesa
Table lamp

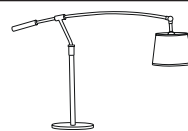

MINA / PALM / 100

Lámparas de suelo
Floor lamp

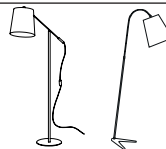

ATRIUM / 102

Lámpara de suelo
Floor lamp

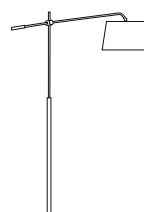

HOLD / 104

Lámpara de suelo
Floor lamp



TRAGALUZ / 106

Lámpara de suspensión
/ mesa / plafón
Ceiling lamp / table / plafond

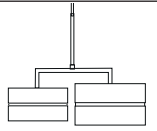

QUASAR / 108

Lámpara de suspensión
/ pared / plafón
Ceiling lamp / wall / plafond

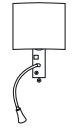

BUBLE / 112

Lámpara de suspensión
Ceiling lamp

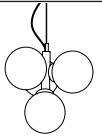

LLUNA / 114

Lámpara de suspensión
/ mesa / plafón
Ceiling lamp / table / plafond

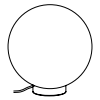

TANSHA / 116

Lámpara de suspensión /
mesa
Ceiling lamp / table

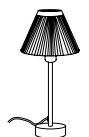

ATHINA / 118

Lámpara de mesa / suelo
Table lamp / floor

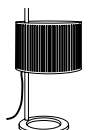

MARSALA / 120

Lámpara de suelo
Floor lamp



VERSUS / 122

Lámpara de suspensión /
mesa / suelo / pared / plafón
*Ceiling lamp / table / floor
/ wall / plafond*



GIRA / LORY / 124

Lámpara de suelo
/ mesa / pared
Floor lamp / table / wall

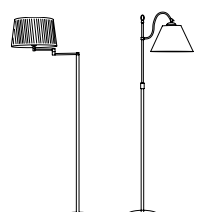

Glass & sheet

AMPORDÁ / 126

Lámpara de suspensión /
mesa / pared
Ceiling lamp / table / wall



TOULOUSE / LOMBARDIA / 128

Lámparas de suspensión /
pared
Ceiling lamp / wall



KARENINA / 130

Lámpara de suspensión /
mesa / pared
Ceiling lamp / table / wall



4

BERKA / 134

Lámpara de suspensión /
mesa / suelo
Ceiling lamp / table / floor

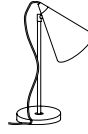

MISTYC / POPPOL / 136

Lámparas de suspensión
Ceiling lamp



BOBBY / CLUB element / 138

Lámparas de suspensión
/ pared
Ceiling lamp / wall



HAT / 140

Lámparas de suspensión / suelo
Ceiling lamp / floor



SPIDER / 142

Lámpara de suspensión
Ceiling lamp



BABE / MINIMATE / 144

Lámpara de mesa /
suelo
Table lamp / floor

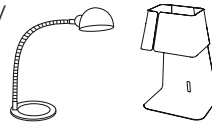

AURA / 146

Lámpara de suspensión
Ceiling lamp

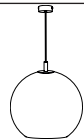

COCO / 148

Lámpara de suspensión
Ceiling lamp



GLASSY / 150

Lámpara de suspensión
Ceiling lamp

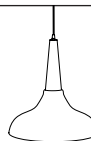

LOFT / PIPPA / 152

Lámpara de suspensión
Ceiling lamp

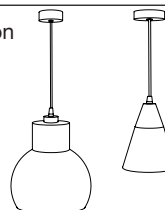

MARS / 154

Lámpara de suspensión
Ceiling lamp

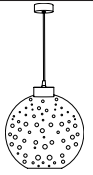

Basics

SIMPLICITY / 158

Lámpara de suspensión / mesa / pared / plafón
Ceiling lamp / table / wall / plafond

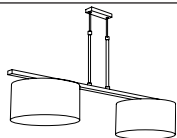

QBOX / 162

Lámpara plafón / pared
Plafond lamp / wall

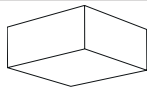

DONA / 164

Lámpara de suspensión
Ceiling lamp

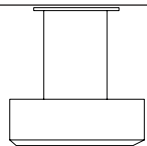

SATIN / 166

Lámpara de suspensión / mesa / plafón
Ceiling lamp / table / plafond

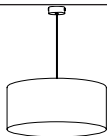

TEX / 168

Lámpara de suspensión / plafón
Ceiling lamp / plafond

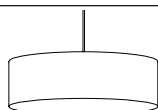

TRIPP Hotel / QUO Hotel / 170

Lámpara mesa / suelo
Table lamp / floor



CHIC Hotel / PETIT Hotel / 172

Lámpara suspensión / mesa / suelo
Ceiling lamp / table / floor

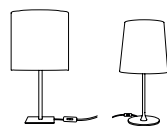

VIENA / 174

Lámpara suspensión / mesa / pared
Ceiling lamp / table / wall

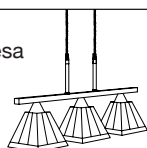

BÁSIC / 176

Lámpara suspensión / mesa / pared / suelo
Ceiling lamp / table / wall / floor



BLANK / 178

Lámpara suspensión / mesa / pared / suelo
Ceiling lamp / table / wall / floor

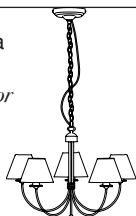

NATURA / VALISSE / 180

Lámpara de mesa / pared / suelo
Table lamp / wall / floor

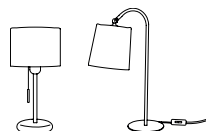

CARRÁ / CIRCA / 182

Lámpara suspensión / plafón / pared
Ceiling lamp / plafond / wall

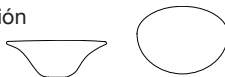

ULM / NICO / 184

Lámpara suspensión
Ceiling lamp

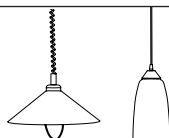

LOUVRE / 186

Lámpara pared
Wall lamp

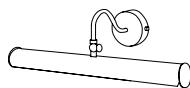

DLED / 188

Lámpara pared
Wall lamp

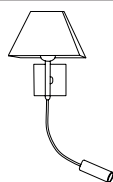

Import

KAMI / 196

Lámpara suspensión / mesa
Ceiling lamp / table



ALUMINUM / 200

Lámpara suspensión
Ceiling lamp

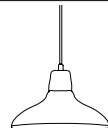

VENTILADORES / 202

Aparatos de Ventilación
Ceiling fan

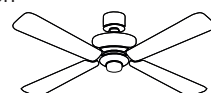

DIY

PANTALLAS / 220

Lampshades



TULIPAS CRISTAL / 226

Glasshades



ESQUELETOS/BOMBILLAS 228

Spare Frames / Bulbs

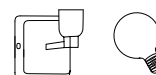

PENDELS / ACCESORIOS 230

Pendant Fixture / Accessories



MUESTRARIO ACABADOS / 234

Finishes Book

DATOS TÉCNICOS Especificaciones

8

LAFFIE

restyling 2016

technical data

242

Laffie triunfa en ambientes que requieren un detalle de estilo retro. Funcional y estéticamente a la última, las lámparas que conforman esta colección arrasan en la decoración de interiores particulares y también en los locales de moda de medio mundo.

"Laffie" triumphs in settings that call for retro-style details. Functional yet fashionable, these lamps are extremely popular both in the decoration of private homes as well as in fashionable bars throughout the world.

Suspensión/Ceiling Lamp//6000



Suspensión/Ceiling Lamp//6001



Suspensión/Ceiling Lamp//6002



Opciones cristal / Glass options



MT

TR

Acabado metal /Metal colour



ANT



VIRGIN OLIVE OIL

WHEAT

MO
VERA P

10

SAVOY

restyling 2016

technical data

242

Paredes de ladrillo visto, muebles de madera y la lámpara Savoy, que añade ese toque afrancesado años 30 al espacio, singular y exquisita pieza. Savoy se presenta en dos acabados de cristal, transparente o al ácido y en metal color latón envejecido. Y en dos formatos, lámpara de cuatro luces o Colgante sencillo de una luz.

Exposed brick walls, carved wooden furniture, and the "Savoy" lamp to add that 1930s French touch to any space. The glass shade is available in two styles, clear or acid-treated, with a metal base finished in antiqued brass. There are also two forms to choose from, a one-light pendant or a hanging bar with four lights.



Suspensión/Ceiling Lamp//6003

Opciones cristal / Glass options



MT

TR

Acabado metal / Metal colour



ANT

Suspensión/Ceiling Lamp//7003 >

Opciones cristal / Glass options



MT

TR



12

CROSBY

restyling 2016

technical data

242

Crosby es una fiel reproducción de las primeras lámparas con tulipa de cristal triplex de principios del siglo XX, que Massmi editó por primera vez en 1992. Suspendidas del techo sólo con su propio cable eléctrico trenzado, como eran antiguamente y a juego con su coqueta versión de aplique de pared. Crosby está disponible en tres tamaños de tulipa para el colgante y tres colores a elegir tanto en el aplique como en el colgante.

Crosby is a faithful reproduction of the first lamps with triplex glass shades, manufactured at the beginning of 20th century. The pendant lamp hangs by a simple braided electric cable, to achieve the retro look, in keeping with the charming sconce version. Crosby comes in three sizes for the pendant lamp and three different colors for both the sconce and the pendant lamps.



Pared/Wall Lamp//1131

Opciones cristal/ Glass options



AMB



OP



VE

Acabado metal / Metal colour



ANT



Suspensión/Ceiling Lamp//6008 -15 / 25 / 30



design 2001

technical data

242

London está inspirada en la original lámpara banquero Emeraldite, un diseño americano de finales del XIX, concebida inicialmente para los contables o "banqueros". Se ha mantenido vigente en sus múltiples adaptaciones hasta nuestros días, convirtiéndose en un icono en el escritorio de muchas series y películas americanas.

Se caracteriza por una sólida base de latón fundido y una tulipa redondeada de cristal opal o verde. London en su versión más clásica o más moderna, ambas representan el espíritu elegante y atemporal de la banker's lamp.

London was inspired by the original banker's emeraldite table lamp, an American design from the end of the 19th century and favored by accountants and bankers. Its iconic form, ever present in classic American films, has remained popular through all its different incarnations over the years.

London has a solid base made of brass and a rounded opal or green glass shade. In both its classic and modern versions, London embodies the elegant spirit of the classic banker's lamp.



^ Mesa/Table Lamp//4115

^ Mesa/Table Lamp//4128 >

Pared/Wall Lamp//1129

Opciones cristal /Glass options

Acabado metal / Metal colour



OP



VE



ANT





16

POIRET

design 1997

technical data

242

Poiret es una versión muy sencilla y geométrica de las maravillosas y exquisitas lámparas Tiffany que se fabricaban en la ciudad de Nueva York desde 1895 hasta 1928. Realizadas con recortes de vidrios opalescentes unidos con cinta de cobre.

Consideradas parte indispensable del movimiento Art Nouveau, se adaptan a la perfección en entornos eclécticos, cottage, Shabby Chic, Vintage o retro. Poiret se presenta en dos modelos de tulipa tanto para los sobremesas como para los apliques.

Poiret is a simple, geometric version of the wonderfully exquisite Tiffany lamps made in New York between 1895 and 1928. Its stained glass is made of cut crystal joined with copper foil for the solder bead. Considered an important icon of the Art Nouveau movement, these lamps harmonize perfectly with a number of decorative styles, from eclectic to cottage, shabby chic to retro. Poiret is available with two different glass shades, both for the sconce and table models



Mesa/Table Lamp//4130

Mesa/Table Lamp//4129

Mesa/Table Lamp//4119 >

Pared/Wall Lamp//1133



Pared/Wall Lamp//1132



Acabado metal / Metal colour



ANT



18

LUIGI

design 1997

technical data

243

La colección Luigi se presenta en sus diferentes versiones de mesa, pared y techo. Realizada en metal acabado latón envejecido y tulipa tiffany combinando color crema con rojo marsala. Fielmente evocadora del estilo parisino refinado y romántico, como lo eran los cafés literarios de la Montparnasse de principios del s.XIX.

The Luigi collection includes a table lamp, sconce, and pendant version. With an antiqued brass base and beige and marsala red tiffany glass shades, the "Luigi" family of lamps evokes a romantic Parisian style reminiscent of the cafés of Montparnasse in turn-of-the-century Paris.



Suspensión / Ceiling Lamp // 7122 - 3/5 luces /lights

Pared / Wall Lamp//1154 (Superior - Up)

Pared / Wall Lamp //1122 -1/2 luces/lights (Inferior - Down)

Acabado metal/ Metal colour



ANT



Suspensión / Ceiling Lamp // 6124 con polea- with pulley
6123 sin polea-without pulley

Mesa / Table Lamp//4122



20

NOUVEAU

design 1999

technical data

243

Nouveau es una revisión moderna y depurada de la iluminación más popular dentro del Art Nouveau, ligeros detalles florales en el cuerpo de las piezas combinados con tulipas en vidrio opal triplex, lo que le otorgan una elegancia y sencillez con sabor retro que le dará un toque muy personal y elegante a cualquier ambiente.

Nouveau is a modern, simplified remake of one of the most popular lamps from the Art Nouveau era. The flower details on the body and the opal triplex glass shades lend any elegant, personal touch to any space.



Suspensión / Ceiling Lamp // 7987 -2/3/5 luces/lights

Pared / Wall Lamp// 1131

Mesa / Table Lamp// 4999

Acabado metal / Metal colour



ANT

Suspensión / Ceiling Lamp // 6127 con polea- with pulley

6135 sin polea-without pulley





TOURNON

design 2016

technical data

243

Siguiendo la estela del art nouveau, los detalles en las cartelas en el cuerpo de las piezas de Tournon están inspiradas en motivos vegetales que Héctor Guimard realizó para la estación de Metro Porte Dauphine en París, inaugurada en 1900. Combinada con una tulipa de cristal al ácido estilo art deco, con motivos geométricos muy similar a la que se exhibió en una de las salas de reuniones del edificio Chrysler en 1929. Sin duda una pieza especial que dotará de una personalidad única tanto a espacios públicos como ambientes privados.

In the spirit of the Art Nouveau movement, the bracket details on the body of the lamps in the "Tournon" family were inspired by the vegetal motifs popularized by Hector Guimard in his design of the Porte Dauphin metro station in turn-of-the-century Paris. The matching art deco acid-treated glass shade has geometric designs similar to those found in the meeting rooms of the Chrysler building, built in 1929. The result is a special lighting fixture that will give a unique character to any public or private space.



Suspensión/ Ceiling Lamp// 7001

Acabado metal / Metal colour



ANT

Sobremesa/Table Lamp// 4001

Pared/Wall Lamp// 1001

22

CANDEL

design 2001

technical data

243

Candel se caracteriza por su sobriedad clásica de estilo holandés, que evoca los antiguos candelabros de vela. Realizada en auténtico acabado latón envejecido, creará una atmósfera rica y poderosa tanto en ambientes clásicos como espacios modernos aportando un personal toque vintage.

The Candel series of lamps is characterized by a classic sobriety typical of Dutch design, reminiscent of the candle chandeliers of a bygone era. Made of antiqued brass, these lamps make a rich, powerful statement, giving a personal vintage touch to both classic and modern spaces.



Pared / Wall Lamp // 1527 - 1/2 luces/ lights

Suspensión / Ceiling Lamp // 7983 - 3/5 luces/ lights

Sobremesa/ Table Lamp // 4909

Acabado metal / Metal colour



ANT



HOLLAND

reedition 2016

technical data

244

Holland es una réplica de la clásica lámpara de estilo colonial holandés. Ha estado presente en nuestro catálogo desde nuestros inicios y ahora la recuperamos dotándola de acabados actuales y fácilmente integrables en cualquier estilo.

Holland is a remake of a colonial Dutch classic. A standard fixture in our catalogue since the very beginning, it has been updated and is now available in more fashionable finishes that fit in easily with any type of decor.



Suspensión/Ceiling Lamp// 6009

Opciones metal / Metal options



D

NI

PV

24

CLUB

design 2001

technical data

244



Club ha sido reeditada manteniendo ese sabor a otra época con su aspecto envejecido en la versión latón, elegante y moderna en acabado plata. Club es una colección muy completa que crea interesantes espacios con un marcado aire retro industrial. Articulable de tal manera que puede adaptarse en altura y orientación de sus pantallas.

The updated "Club" series maintains its classic touch in its original antiqued brass version, but is now available in a silver finish for a more elegant, modern look. Club is a complete collection that creates interesting spaces with a marked industrial retro air. Its articulated frame ensures that both the height of the lamp and the lampshade position are completely adjustable.



Suspensión / Ceiling Lamp // 6894 - 12 /17 /30 /38 /45

^ Suspension / Ceiling Lamp // 6895 -1/2/3/5 luces/lights >

Opciones metal / Metal options



ANT



PL



26



technical data

244



^ Suspensión / Ceiling Lamp // 6895 - 1/2/3/5 luces/ lights

Mesa / Table Lamp// 4275

Opciones metal / Metal options



ANT



PL

Suspensión / Ceiling Lamp // 6894 - 12 /17 /30 /38 /45>



28

technical data

244

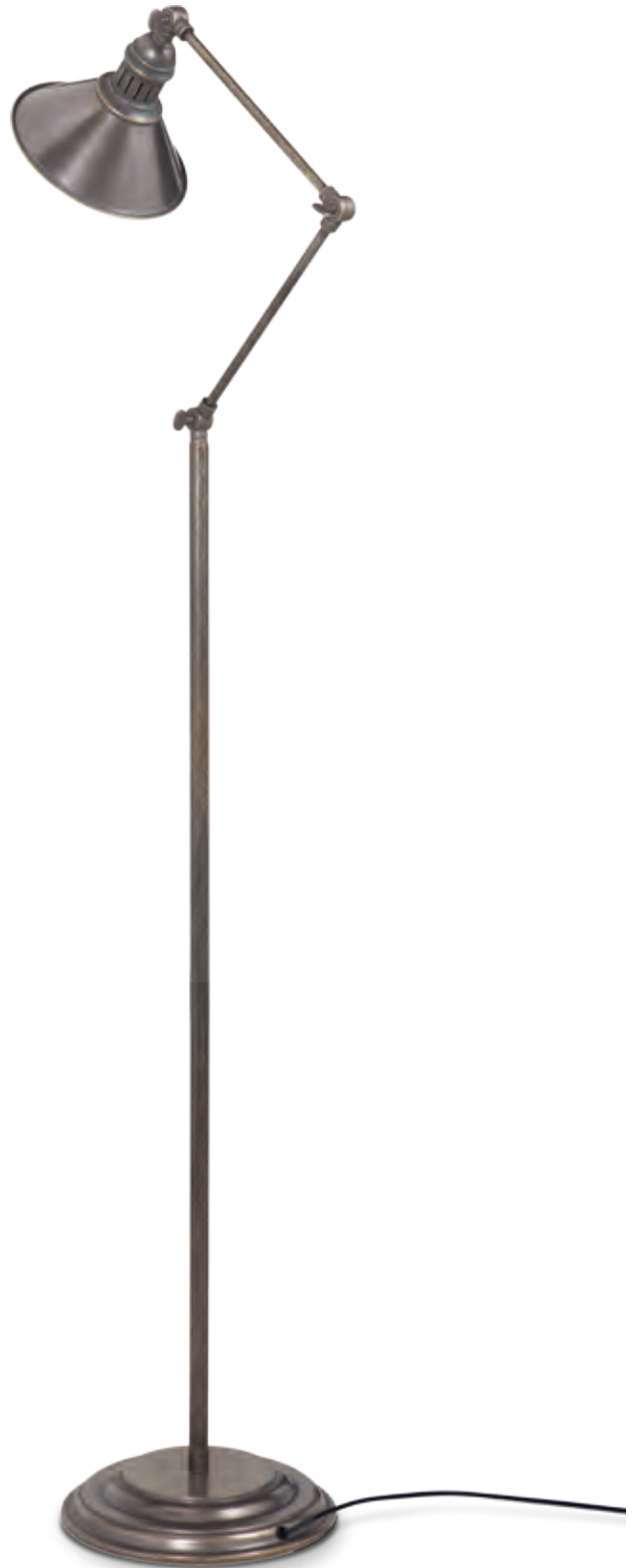

Suspensión/Ceiling Lamp // 6128

Mesa/Table Lamp // 4276

Suelo/Floor Lamp // 5264

Mesa/Table Lamp // 4275 >

Opciones metal / Metal options



ANT



PL



30

technical data

244



Pared/Wall Lamp // 1614 (superior/ up)

Pared/Wall Lamp // 1615 (inferior/ down)

Suspension/ Ceiling Lamp // 6895 -1/2/3/5 luces/ lights

Opciones metal / Metal options



ANT



PL

Pared/Wall Lamp // 1614>

Suspensión / Ceiling Lamp // 6894 - 12 /17 /30 /38 /45



32

technical data

244



Pared/Wall Lamp // 1617

Suelo /Floor Lamp // 5264

Opciones metal / Metal options



ANT



PL



34

CLUB *shade*

design 2016

technical data

244

Shade es la versión más relajada de Club, evocadora de cierto espíritu campestre y bucólico, aportando al ambiente un refinamiento natural y cálido. Cuerpo de metal en acabado plata o latón envejecidos y pantalla en lino crema. Articulada y de pantalla orientable que permiten ajustar la posición y altura de la lámpara.

shade constitutes a relaxed version of the "Club" series, lending a rural, bucolic feel while adding a warm, refined air to any space. Its metal body is available in antiqued brass or silver finishes with a cream-colored linen lampshade. Both the height of the lamp and the lampshade position are fully adjustable.



Pared/Wall Lamp // 1618 (superior-up)

Pared/Wall Lamp // 1619 (inferior-down)

Mesa / Table Lamp// 4286 (pequeño-small)

Mesa / Table Lamp// 4287 (grande-big)



Suelo /Floor Lamp // 5267

Suspensión / Ceiling Lamp // 6896 - 1/2/3/5 luces/ lights

Opciones metal / Metal options

Acabado pantalla / Shade colour



ANT

PL

LI



36

LABOHÈME

restyling 2016

technical data

245

La Bohème tiene esa mezcla entre clásico y provenzal tan atractivo, que se adapta a la perfección en los distintos estilos de la decoración más actual aportando un toque muy personal. La Bohème se presenta en una completa familia de luminarias realizadas en latón envejecido.

La Bohème is an attractive mixture of classic and Provencal style. It fits in perfectly with even the most contemporary decorative styles, adding a distinctive personal touch. "La Bohème" is a complete family of lighting fixtures made of antiqued brass.



Suspensión /Ceiling Lamp // 6116

Pared/Wall Lamp // 1556

Acabado metal / Metal colour



ANT



Suspensión / Ceiling Lamp // 7116 -3/5 luces/ lights



Mesa/Table Lamp // 4936

Suelo/Floor Lamp // 5216 >



38

JABEL

design 2001

technical data

245

Desde hace décadas Jabel es una pieza insustituible en nuestro catálogo para quienes gustan de ambientes más clásicos y con cierto aire romántico. De cuerpo acabado en latón envejecido y ligeramente torneado, viste pantalla de algodón tableado.

For several decades, "Jabel" has been an irreplaceable element of our catalogue, designed for clients who want a classic, yet romantic style. Comprised of a body of slightly turned, antiqued brass with a pleated cotton lampshade.



Mesa/Table Lamp // 4133
Acabado metal / Metal colour



Suspensión/Ceiling Lamp // 7138 - 3/5 Luces/ lights



Pared /Wall Lamp // 1532 -1/2 luces/ lights



Suelo/Floor Lamp // 5129

Acabado metal+madera/
metal+wood colour



Suelo/Floor Lamp // 5240

TALIS

design 2001

technical data

245

Talis es otro clásico en la fabricación de Massmi, un foco de luz más localizado que creará un espacio cálido y acogedor allá donde esté. De corte tradicional y elegante. Las piezas Talis son tan versátiles, que se pueden integrar fácilmente en diferentes ambientes y estilos.

Talis is another classic piece in the Massmi catalogue, a family of lamps that simultaneously create a focused beam of light and a warm, cozy space. With its traditional, elegant forms, the "Talis" family of light fixtures harmonizes with many different types of decorating styles.



Pared/Wall Lamp // 1612

Acabado Metal / Metal colour





40

LARA

design 1979

technical data

245

Con Lara retornamos a un pasado tal vez por muchos reconocido, en el recuerdo de la casa de nuestra abuela, en el pasillo de un hotel en Lyon o sobre la barra de un vetusto café. Lara se compone de plafones de techo y colgantes de latón envejecido y vidrio opal triplex y ácido.

Lara evokes a comforting nostalgia, stirring memories of visiting grandmother's house, holidays spent in a cosy French hotel, or sipping coffee in a corner café. "Lara" comes either as a flushmount ceiling lamp or as a pendant lamp with an antiqued brass finish and triplex opal glass.



Plafón /Plafond Lamp // 3433



Plafón /Plafond Lamp // 3452



// 3451



// 3428



// 3450









Acabado metal / Metal colour



PV



Suspensión /Ceiling Lamp // 6006  // 6007-16  // 6005  // 6004  // 6007-18 
Acabado metal / Metal colour

PV

46

LITE

design 2014

technical data

246

La lámpara de foco se la reconoce tradicionalmente en mercados, tabernas y cafeterías. Lite es un reconocimiento a esa funcionalidad y simplicidad tan característica. Hoy muy presente en estilos retro-industrial, también encaja a la perfección en espacios sacandi o rústicos. Lite se presenta en cuatro acabados en sus versiones colgantes y sobremesa.

Spotlights have traditionally been used in markets, cafes, and bars. "Lite" embraces this characteristic functionality and simplicity. Extremely popular in retro decor, "Lite" also works well in Nordic or rustic settings. Available in four colors for both the pendant and table lamp styles.



Suspensión / Ceiling Lamp // 6975



// 6973



// 6977



// 6974



Opciones metal / Metal options



BL-MT

CO

LA

NE-MT



Mesa / Table Lamp // 4425

Opciones metal / Metal options



BL-MT CO LA NE-MT

48

SLIM

design 2016

technical data

246

Slim es una muestra de la atemporalidad de las formas sobrias y de la sencillez escultórica de lo tradicional. Slim destaca por generar un ambiente sobrio y cálido. Se presenta en cuatro acabados blanco mate, negro mate, latón brillo y cobre satinado.

Slim is an example of the timelessness of sober forms and the simplicity of traditional design. Slim creates a warm, elegant atmosphere. Available in four colors: matte white, matte black, glossy antiqued brass, and semi-matte copper.

Suspensión / Ceiling Lamp // 6982

Opciones metal / Metal options





50

GARLAND

design 2015

technical data

246

Garland es un homenaje a esa estética de la bombilla incandescente que tantos y tantos años nos ha acompañado. Desnuda y apoyada en una simple estructura tubular en distintos acabados pasa a ser la gran protagonista de la decoración.

Garland is a homage to the bare incandescent bulb aesthetic, which has been there from the very beginning. Stripped of unnecessary decoration and supported by a simple tubular structure, Garland becomes the star of the show in whatever decor it is used.



Suspensión /Ceiling Lamp // 6979 -3 luces/ lights

Suspensión /Ceiling Lamp // 6981 -1 luz/ light

Opciones metal / Metal options



Suspensión /Ceiling Lamp // 6980 - 4 luces/ lights

Mesa /Table Lamp // 4419



52

BULB

design 2015

technical data

247

Las Bulb encajan en todo tipo de ambientes. La sencillez del portalámparas en madera de Haya es toda su esencia y naturalidad. Se presenta en dos formatos, que combinados crean sutiles y elegantes composiciones.

Bulb fits in anywhere. The natural essence of Bulb emanates from the simplicity of its beechwood socket. The different combinations made possible by the two socket and bulb size options help create elegant lighting fixture compositions.



Mesa /Table Lamp // 4440
Acabado madera / Wood colour



HA



Suspensión /Ceiling Lamp // 6992 (madera larga) / (long wood)
Suspensión /Ceiling Lamp // 6991 (madera corta) / (short wood)



56

NAAF

design 2016

technical data

247

A veces los materiales "de toda la vida" encuentran una nueva identidad, gracias al trabajo de diseñadores y artistas que vuelven la vista atrás. Nos encontramos en un momento en el que recuperar labores artesanales está más en auge que nunca, y bienvenida sea esta moda si permite que ciertas profesiones y trabajos no se pierdan para siempre. Naaf es fruto de esa nueva identidad y encuentro entre pasado y presente en los materiales, natural y sofisticada, ligera y rotunda a la vez. Realizada en pantalla de Rafia entretejida y cuerpo de metal acabado en blanco mate.

Sometimes classic materials receive new life thanks to the designers who look to the past for inspiration. Currently, the fashion is to try and recuperate artisan work. We think this is a welcome trend, especially if it means conserving certain skills and traditions that would otherwise be lost forever. Naaf is the result of this new tendency, a meeting of past and present. Its materials are natural, yet sophisticated, with an airy look and solid feel. The metal from has a matte white painted finish with a shade made of raffia.



Mesa/Table Lamp // 4457 (peña/little)

Suspensión /Ceiling Lamp // 6857

Mesa/Table Lamp // 4458 (grande/big)

Acabado metal / Metal colour

Acabado pantalla / Shade colour



BL-MT



RA





58

INFINITO

design 2003

technical data

247

Un clásico atemporal. Pieza angular de interioristas, Infinito aúna sobriedad formal y funcional. El tubo central metálico soporta una pantalla de color crudo (retorta). Versátil y elegante gran aliada de quien guste una iluminación cálida y confortable.

A timeless classic, Infinito combines formal and functional elegance. The lamp consists of a central metal tube topped with a beige canvas lampshade. Stylish and versatile, Infinito is for people who want warm, comfortable lighting.



Suspensión/Ceiling Lamp // 6808 Mesa/Table Lamp // 4250 (grande/big) Mesa/Table Lamp // 4248 (peño/little) Suelo/Floor Lamp // 5250

Opciones metal / Metal options

Acabado pantalla / Shade colour



D

NI

RE



60

INFINITO 45°

design 2010

technical data

247

Nueva opción de infinito con pantalla giratoria. Cuerpo en níquel o dorado satinado y pantalla de algodón plisada, para quien busque una versión más práctica de esta inconfundible pieza.

This new edition of our classic "Infinito" lamp has a fully adjustable lampshade. With a nickel or satin brass body topped with a pleated cotton lampshade, this is an even more practical version of an old favorite. .



Suspensión/Ceiling Lamp // 6844 Mesa/Table Lamp // 4398 (grande/big) Mesa/Table Lamp // 4397 (peño/little) Suelo/Floor Lamp // 5397

Opciones metal / Metal options Acabado pantalla / Shade Colour



D

NI

CR



INpleat

design 2014

technical data

247

Su nombre In ya subraya su principal característica formal, el leve retranqueo interior del difusor buscando un efecto lucernario, además de ofrecer así una alternativa a este tipo de luminarias. Encuentra su atractivo en la simplicidad y nitidez y su practicidad en las versiones de plafón a techo con sistema imantado. De estructura circular en algodón plisado, ligeramente despegada del techo filtra la luz generando un suave halo luminoso.

The word "In" reflects the main feature of this lamp, namely the slightly concave shape of the diffuser to give a "lucernario" or skylight effect. Its beauty lies in its simplicity and practicality, with its round frame covered with pleated cotton material. The flushmount model has magnets for easy installation. The semi-flushmount model creates a halo of light around the fixture, adding to the overall effect.



Suspensión/Ceiling Lamp // 6941-50/70

Plafón/Plafond Lamp // 3493 -50/70

Acabado pantalla / Shade colour

Acabado metal / Metal colour



CR



NI

62

IN iris

design 2010

technical data

247

Quizás la versión más atrevida de la Colección In es ésta. Compuesta de plafones de techo y colgantes en distintos tamaños, al igual que en las otras series. La sorpresa está en el material iridiscente de la orla interior, que genera un especial efecto lumínico y decorativo.

This is perhaps the most daring version of our "In" collection, consisting of flushmount or pendant lamps in various sizes. The surprise stems from the iridescent material used inside the shade, which creates a special light and decorative effect.



Suspensión/Ceiling Lamp // 6923 -50/70 Plafón/Plafond Lamp // 3476 -50/70

Acabado metal / Metal colour



NI

Opciones pantalla / Shade options



BL



NE



LOULU

design 2001

technical data

248

El triángulo que generan los tres tubos metálicos replicando la estructura de tienda de campaña india, sin necesidad de soporte en la base, junto con una generosa pantalla en tres opciones de material, proveen a Loulu de un atractivo visual y polifacético indiscutible, para crear una renovada atmósfera en espacios monótonos y asépticos.

Three metal tubes come together to make a teepee-like frame without the need for a solid base. Topped with an oversize lampshade available in three different materials, Loulu is an attractive lamp that goes anywhere, lending a fresh look to even the most somber space.



^ Mesa/Table Lamp // 4370
Suelo/Floor Lamp // 5370

Versión Acrílico / Acrylic version



Opciones Metal / Metal options



^ Mesa/Table Lamp // 4137
> Suelo/Floor Lamp // 5137

Versión Algodón plisado / Cotton pleated version

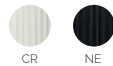

Opciones Metal / Metal options



Suelo/Floor Lamp // 5379 >
Mesa/Table Lamp // 4420 >

Versión Lamitex / Lamitex version



Acabado Metal / Metal colour





66

HANG OUT

design 2007

technical data

248

Hang Out impone verticalidad jugando entre una rotunda solidez y la ingravidez imaginaria. Pantalla de algodón crudo plisado o blanco soft, incorpora en su interior un mecanismo que permite graduar su altura y es posible instalarla a techo o bien enchufarla en un rincón especial, genera una luz intimista y confortable en el espacio.

Hang Out gives a vertical look to any space, with its illusion of solidity even as it hangs in the air. Available with a pleated cotton shade in natural ivory or soft white cotton, Hang Out has an embedded system for adjusting the height of the lamp. You can choose between a ceiling connection or a plug connection to add warmth and light to any cosy nook.



^ Suspensión/Ceiling Lamp // 6845-C (a enchufe)
// 6845-S (a techo)

Acabado metal / Metal colour



NI

Opciones pantalla / Shade options

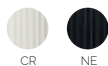

CR

NE

Suspensión/Ceiling Lamp // 6846-C (a enchufe) >
// 6846-S (a techo)

Acabado metal / Metal colour



NI

Acabado pantalla / Shade colour



BL



FUSTA

design Nacho Timón 2011

technical data

248

Fusta aporta una versión racional, moderna y elegante a este tipo de luminarias que integran mueble auxiliar y lámpara. Base realizada en distintos acabados de madera donde se inserta el pie metálico que soporta la pantalla cúbica de esquinas redondeadas en algodón soft blanco. Situada en un rincón de lectura, junto a una butaca o a orillas del sofá es sorprendentemente funcional.

Fusta is a modern and elegant collection of lighting fixtures that incorporates a lamp into an actual side table. The metal lamp frame is incorporated directly into the wooden base, which is available in various colors. Topped with a soft white cotton shade, Fusta is the perfect lamp to put either next to a sofa or armchair or to adorn a special reading nook. It embodies practicality at its best.



^ Suelo/Floor Lamp // 5390

^ Suelo/Floor Lamp // 5391

Opciones madera / Wood options

Acabado metal / Metal colour

Acabado pantalla / Shade colour





70

ELEGANCE

design 2003

technical data

248

La serie Elegance está concebida para iluminar de manera sencilla y limpia tanto un entorno doméstico como otros espacios. Su pantalla en formato piramidal de algodón blanco soft se apoya en un pie de metal y sección circular telescópico que permite jugar con la altura de la luminaria. La lámpara de suspensión de estructura cruzada se despliega desde el centro a la medida que requiera el espacio, a la ligereza de su estructura se suma un dinamismo formal muy elegante.

The Elegance collection of lamps was designed to illuminate any kind of space with a simple, clear light. The pyramid-shaped shade made of warm white cotton tops a metallic, telescopic base. In this way, Elegance can either be used as a table or floor lamp. The pendant model has a criss-cross structure, lending it dynamism and, of course, elegance.



^ Suspensión/Ceiling Lamp // 6815 -30/40
Mesa/Table Lamp // 4296 (grande/big) Mesa/Table Lamp // 4295 (peño/little)

Acabado metal / Metal colour

Acabado pantalla / Shade colour



^ Suelo/Floor Lamp // 5255

Suspensión/Ceiling Lamp // 7210 >



72

BLUR

design 2010

technical data

248

Inspirada en los juegos de volúmenes curvilíneos del museo Guggenheim, Blur juega divertida con el desenfoco que producen los halos de luz superpuestos y desiguales de su estructura cónica escalonada. Compuesta por pie de metal y estructura de pantalla en algodón blanco opaco. No deja indiferente aportando un guiño moderno y sorprendente al espacio.

Inspired by the curved volumes of the Guggenheim Museum, Blur plays with the irregular halos of light that emanate from its multitiered, cone-shaped shade. The opaque white cotton shade sits atop a metallic base, a wink to Modernism that adds a surprising look, leaving no one indifferent.



Suspensión/Ceiling Lamp // 6930

Opciones metal / Metal options



BL NE-MT

Suelo/Floor Lamp // 5364

Opciones pantalla / Shade options



BL NE

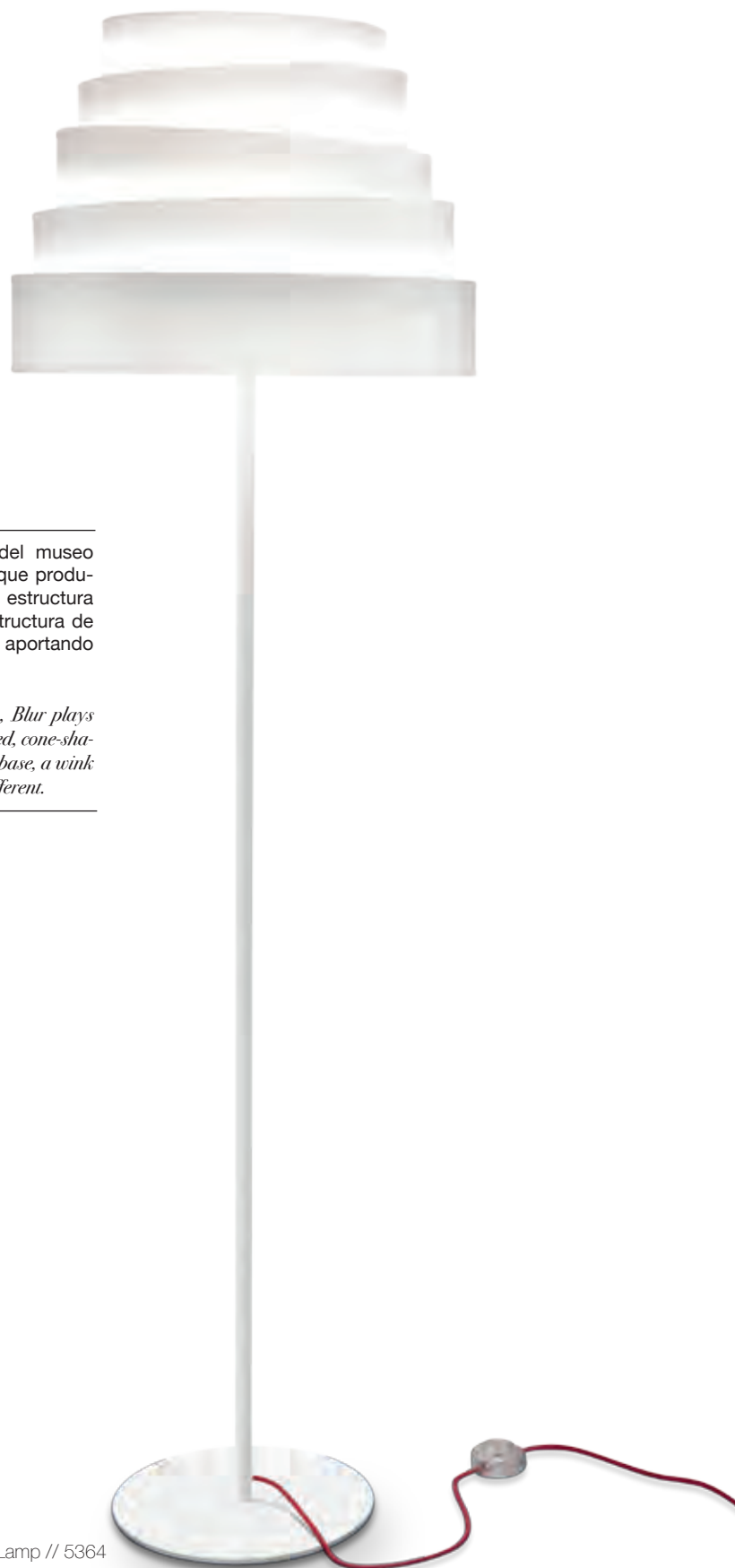



74

TO BE

design 2007

technical data

249

To Be flota en el aire suspendida por un fino cable de acero y equilibrada a modo de balanza por un sistema interior que termina con contrapeso también suspendido y permite a la lámpara ser regulada en altura. La pantalla se presenta en varios acabados y colores, Acrílico blanco y negro y en seda electra gris y crema.

To Be floats in the air on a thin steel cable. The lamp is balanced with a concealed counterweight, making the height of To Be fully adjustable. The shade is available in various materials and colors, including white or black acrylic and electric grey or cream-colored silk.



^ Suspensión/Ceiling Lamp // 6931

Versión acrílico / Acrylic version



BL

NE

Opciones metal / Metal options



NI

BL

NE-MT

^ Suspensión/Ceiling Lamp // 6932 >

Opciones pantalla / Shade options



CR

GR





76

BORROCO

design 2006

technical data

249

Borroco fue en su día un retorno a la sofisticación y una actualización de la iconografía clásica en iluminación. Ha logrado sostenerse como un clásico en el corazón de nuestro catálogo. La presentamos actualizada en sus diferentes versiones de sobremesa, de pie y de techo, apostando por el lujo accesible que recupera en la decoración los dorados y plateados de siempre, con estos nuevos acabados.

Borroco marks a return to the sophistication of an iconic lighting fixture. Today, this lamp continues to be a classic in our catalogue. Fully updated, Borroco is a complete series with table, floor, and pendant lamp models. The series brings back the luxury of the gold and silver tones of yesteryear, but with more accessible, modern finishes.



Suspensión/Ceiling Lamp // 6854

Mesa/Table Lamp // 4454 (pequeño/little)

Suelo/Floor Lamp // 5454

Opciones metal / Metal options

Opciones Pantalla / Shade options



Mesa/Table Lamp // 4455 (grande/big) >



78

technical data

249



Mesa/Table Lamp // 4453 (grande/big)

Mesa/Table Lamp // 4452 (peño/little)

Suelo/Floor Lamp // 5452

Opciones metal / Metal options

Opciones pantalla / Shade options

Suspensión/Ceiling Lamp // 6852 >

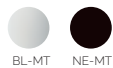





80

INgold

design 2015

technical data

249

In Gold es nuestra interpretación más “cool” de este tipo de luminarias empleada tradicionalmente como pieza de iluminación general. Jugando con el algodón crema y un material técnico en oro mate, el resultado es una pieza discreta con un toque especial que la hace idónea como elemento decorativo.

Gold is our “coolest” version of this family of lighting fixtures, used traditionally for general overhead lighting. By combining warm white cotton and an industrial material in matte gold, the result is a lamp with a special look, perfect as a functional decorative element.

Plafón/Plafond Lamp // 3494 -50/70

Opciones pantalla / Shade options

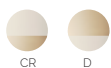

CR

D

Acabado metal / Metal colour



DM

Suspensión/Ceiling Lamp // 6942 -50/70 >



82

KAIRÓS

reedition 2016

technical data

250

Kairós de estructura esbelta y arbolada, funcional y con cierto aire futurista en su magnífico chandelier, se presenta en versiones de sobremesa, pie y techo. Cuerpo en blanco o negro mate y pantallas de doble material con interior en dorado opaco.

Kairós has a slim, tree-shaped structure, making it functional, but with a futuristic air. The collection includes a table lamp, floor lamp, and chandelier. The frame comes in black or white with a two-tone shade, the interior of which is gold in color.



Mesa/Table Lamp // 4421

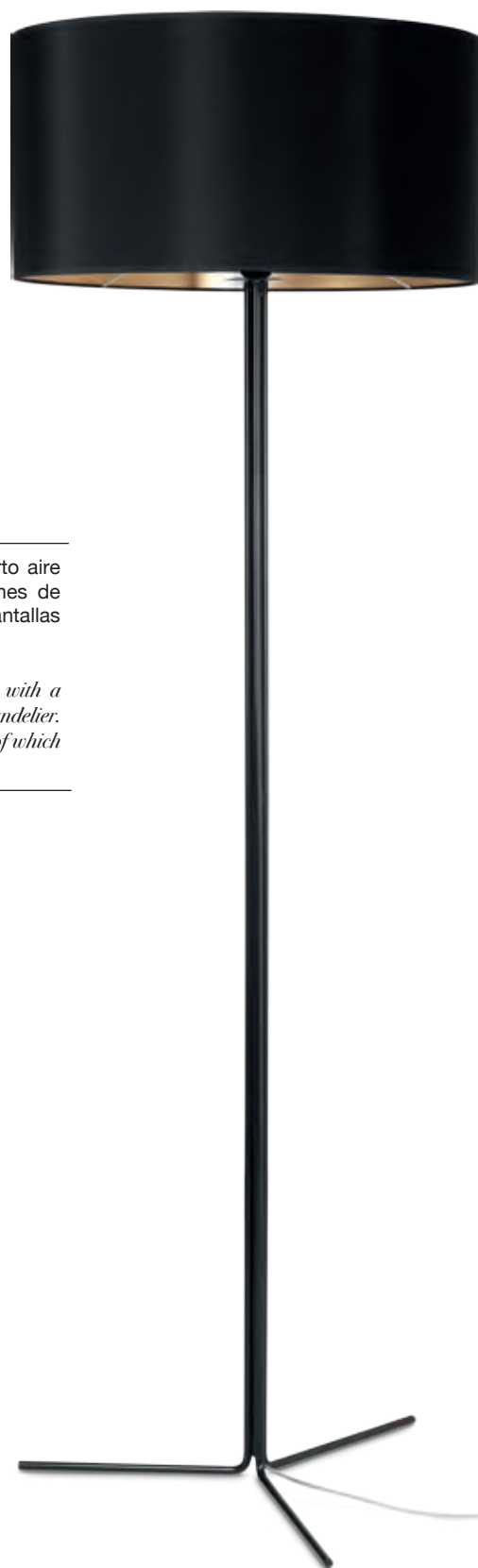

Suelo/Floor Lamp // 5421

Suspensión/Ceiling Lamp // 7421 >

Opciones metal / Metal options

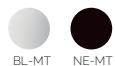

Opciones pantalla / Shade options

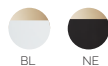



84

ABBY

design Nacho Timón 2016

technical data

249

Abby se abre en forma de pétalos, lo que le confiere un aspecto ligero y dinámico a la vez. La pantalla en algodón es fabricada a mano en doble acabado, exterior blanco o negro e interior oro mate. Se adapta igual de bien en el salón de la casa más exigente o en el hall del hotel más elegante.

The frame of our Abby floor lamp opens up in the form of flower petals, giving it a light, dynamic look. The two-tone shade is handmade, with the exterior in white or black cotton and the interior in a gold finish, making Abby the perfect lamp for a stylish living room or the most elegant hotel.



Mesa/Table Lamp // 4429

Suelo/Floor Lamp // 5429

Opciones metal / Metal options

Opciones pantalla / Shade options

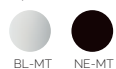

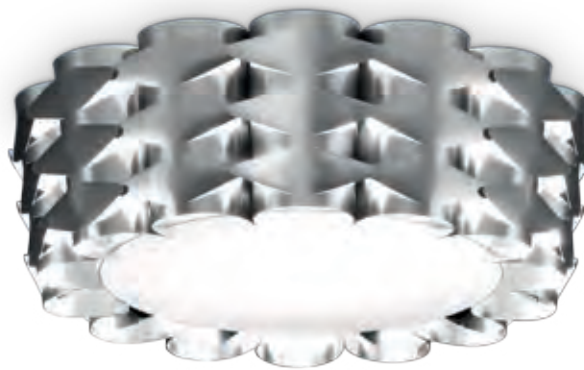

ORIGAMI

design 2008

technical data

250

Origami está inspirada en los juegos de papiroflexia japoneses. Su particular entramado de pantalla, realizado artesanalmente, le confiere una difusión de la luz con caprichosos juegos que se proyectan en el ambiente. Una pieza que no deja indiferente, muy sugerente. En versiones blanco, oro y plata, se adapta a cualquier necesidad tanto residencial como en espacios contract.

Origami is inspired by the Japanese art of paper folding. The handmade shades are specially joined to provide a nuanced play of light. Available in white, gold, and silver, this suggestive lighting fixture fits in with any type of home or office setting. bestseller list. Unchallengeable.

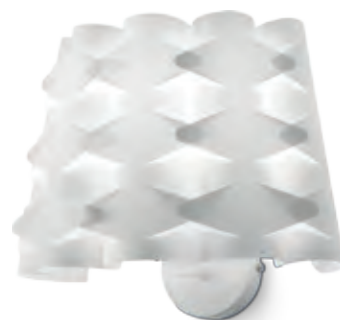

Mesa/Table Lamp // 4355

Suspensión/Ceiling Lamp // 6916 -40/60/80

Pared/Wall Lamp // 1666

Plafón/Plafond Lamp // 3474

Opciones metal / Metal options

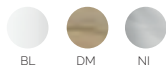

BL

DM

NI

Opciones pantalla / Shade options

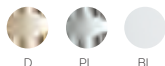

D

PL

BL

86

INFINITO *nordic*

design 2015

technical data

251

Con Infinito versión Nordic hacemos nuestro pequeño homenaje al estilo escandinavo que tanto ha aportado al diseño y la decoración en el empleo de materiales nobles, en particular la madera. Nordic consta de pantallas orientables en sus versiones de sobremesa. La pantalla está realizada en dos tipos de madera a elegir, haya natural y fresno tintado en blanco.

Our new version of "Infinito" is a homage to Scandinavian style, which revolutionized the design world with its use of noble materials, especially wood. The table lamp version has adjustable shades made of wood and is available in either natural beech or bleached ash.



Mesa/Table Lamp // 4432P (pequeño/little) Mesa/Table Lamp // 4432G (grande/big)

^ Suspensión/Ceiling Lamp // 6802 >

Acabado metal / Metal colour



BL-MT

Opciones pantalla / Shade options



BL



HA



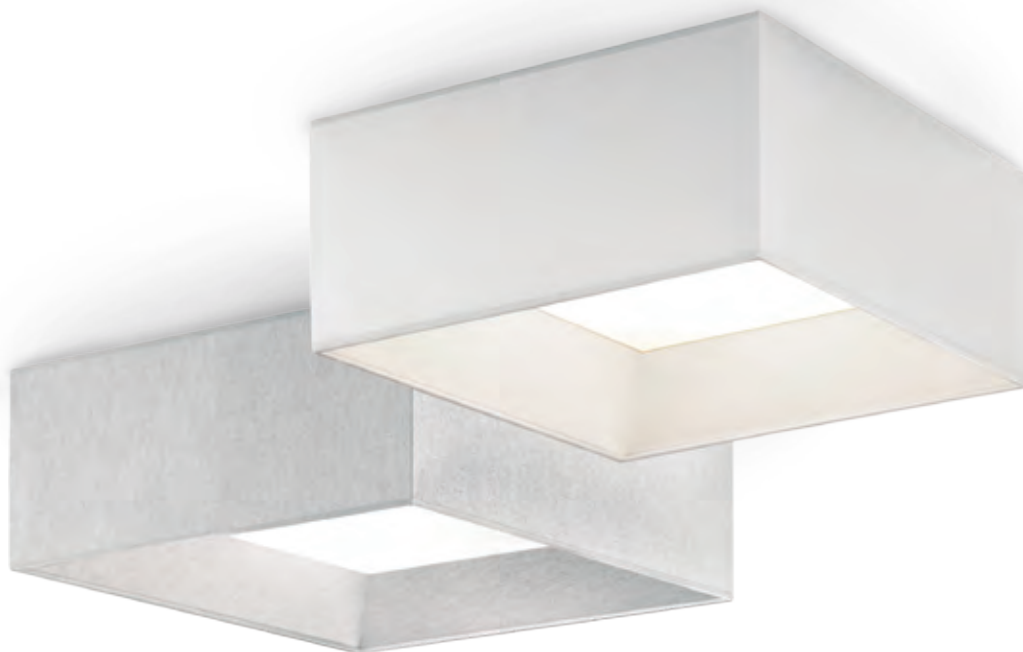

90

VOLUM *basic*

design 2011

technical data

250

Esta es la versión básica, y se presenta en un único tamaño de alto y en tres de ancho. Dos acabados de pantalla, electra crema y gris.

The basic version of "Volum" comes in one height, with three widths available. The shade comes in either electric cream or grey.

Plafón/Plafond Lamp // 3488 -35x35x18 /40x40x18 /50x50x20

Opciones pantalla / Shade options





GATE

design 2012

technical data

251

En Gate destaca su asimetría y generoso tamaño, que lo hace ideal para iluminar espacios que requieran una luz cenital y uniforme. Aporta un toque futurista y escultural al espacio. El cuerpo blanco de la pantalla aúna elegancia y discreción.

Gate stands out for its asymmetry and sheer size, perfect for lighting spaces which need a strong, uniform light. Its sculpted white shade combines elegance and discretion, giving the space a futuristic look.

Suspensión/Ceiling Lamp // 6947

Acabado metal / Metal colour

Acabado pantalla / Shade colour



NI



BL

92

SIXTIE

reedition 2008

technical data

251

Sixtie tiene su origen ya en nuestro catálogo en la década de los 60, cuando en lugar de una pantalla de tela se realizaba en metal, ahora actualizada desde un punto de vista más elegante y cálido se presenta en tres acabados blanco brillo, negro mate y oro brillo en su cuerpo y dos colores de pantallas de algodón a elegir, blanco o negro.

Sixtie appeared in the original Massmi catalog back in the 1960s. Its original metal shade has been replaced with an updated cloth shade, adding elegance and warmth. The metal base is available in three colors: glossy white, matte black, and polished gold. The cotton shade is available in white or black.



Mesa/Table Lamp // 4460 (grande/big)

Mesa/Table Lamp // 4459 (peño/little)

Suelo/Floor Lamp // 5459

Opciones metal / Metal options

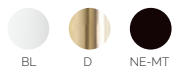

Opciones pantalla / Shade options







94

INFINITO

design 2003

technical data

251

Un clásico atemporal. Pieza angular de interioristas, Infinito aúna sobriedad formal y funcional. El tubo central metálico soporta una pantalla que en esta versión es de algodón opaco blanco o negro. Versátil y elegante gran aliada de quien guste una iluminación cálida y confortable.

Infinito is a timeless classic that combines form and function in its angular presentation. The central metal base is topped with a black or white cotton lampshade. Versatile and elegant, Infinito is the perfect fixture for those seeking a warm light to enhance any setting.

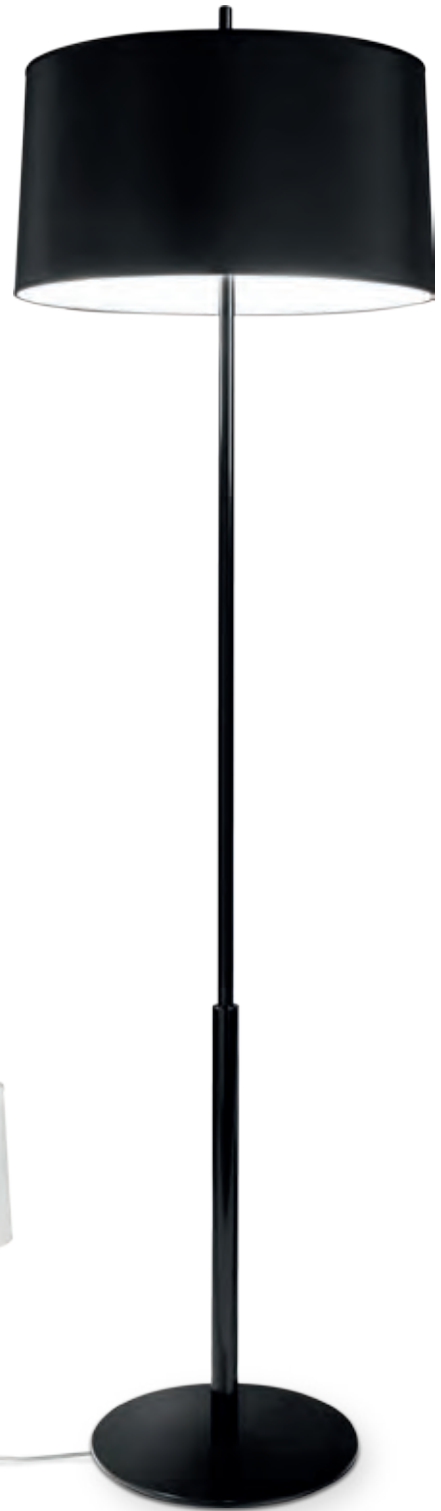

Mesa/Table Lamp // 4379 (grande/big)

Mesa/Table Lamp // 4378 (peño/little)

Suelo/Floor Lamp // 5368

Suspensión/Ceiling Lamp // 6928

Opciones metal / Metal options



Opciones pantalla / Shade options





IN

design 2010

technical data

252

In hace referencia a la principal característica formal de esta serie, el leve retranqueo interior del difusor provocando un efecto lucernario y a la opacidad de la pantalla que potencia este efecto tan característico de esta serie de luminarias. Su estructura circular en esta opción está revestida de algodón opaco blanco o negro.

The word In reflects the main feature of this lamp, namely the slightly concave shape of the diffuser to give a skylight effect. Its beauty lies in its simplicity and practicality, with its round frame covered with pleated cotton material. The flushmount model has magnets for easy installation.



Suspensión/Ceiling Lamp // 6925 -50/70

Plafón/Plafond Lamp // 3478 -50/70

Opciones pantalla / Shade options

Opciones metal / Metal options



96

INFINITO 45°

design 2010

technical data

252

Esta versión de Infinito incorpora un cabezal móvil que permite orientar la pantalla y el haz de luz, lo que la hace ideal situada junto al sofá o en una butaca de lectura. La silueta de la versión más básica se trastoca levemente sin ceder un milímetro de elegancia, sumando funcionalidad.

Infinito 45° is the latest model within our "Infinito" family of light fixtures. The lampshade is adjustable, making "Infinito 45°" the perfect reading lamp to accompany a sofa or armchair. The silhouette of the most basic version has been updated without changing its original elegance and functionality.



Mesa/Table Lamp // 4395 (peño/little)

Mesa/Table Lamp // 4396 (grande/big)

Suelo/Floor Lamp // 5395

Suspensión/Ceiling Lamp // 6962

Opciones metal / Metal options



BL

NE-MT

CR

NI

Opciones pantalla / Sshade options



CR

GR

BL

NE



IN *Electra*

design 2010

technical data

252

In electra está revestida de un tejido satinado translúcido , que permite el paso de la luz, lo que hace que todo el cuerpo se convierta en emisor de luz ambiente, generando una atmósfera muy cálida.

In Electra is covered with a translucent satin material that allows light to pass. This converts the entire lamp into a subtle light source, creating a warm light for intimate settings.



Suspensión/Ceiling Lamp // 6924 -50/70

Plafón/Plafond Lamp // 3477 -50/70

Opciones pantalla / Shade options

Acabado metal / Metal colour



98

LOBBY

reedition 2011

technical data

252

La fluidez de movimientos de Lobby y su perfecta estabilidad hacen de este flexo un punto de luz que se puede mover alrededor de la mesa sin apenas ocupar espacio y dirigir el haz de luz con precisión. Esta lámpara articulada, es totalmente orientable para facilitar la lectura. Lobby se presenta en blanco mate y negro mate o en níquel satinado, siempre con la parte extensible en cromo. Su difusor de pantalla está realizado en cotton opaco blanco o negro.

The fluid movements of Lobby and its perfect stability transform this desk lamp into a light source that can focus light with precision on any part of the desk without taking up hardly any space. This articulated lamp is totally adjustable, making it the perfect reading lamp. Lobby is available in matte black or white or a brushed nickel finish; the horizontal arm has a chrome finish in all models. The shade diffuser is available in opaque black or white cotton.



Mesa/Table Lamp // 4384

Opciones metal / Metal options



Opciones pantalla / Shade options





American Wood Type Co. New York, N.Y.
CHICAGO Fair 6
BLUE SKIES 2
RESCUE 15
HOME 9
BRIG 2



100 MINA

design 2012

technical data

252

El sencillo mecanismo de Mina se consigue mediante una doble rótula en su brazo que permite cambiar la altura de la pantalla para adaptarse a las necesidades del usuario. La pantalla ofrece una rotación de 90° para dirigir el haz de luz hacia donde convenga. La ligereza de su estructura confieren a Mina un aire próximo y a la vez una marcada personalidad

Mina has a simple, double-jointed mechanism that makes this lamp fully adjustable. The shade pivots in a 90° angle to focus the light in any direction. Its airy design gives Mina a familiar look, but with a personality all its own.



Suelo/Floor Lamp // 5393

Acabado metal / Metal colour



NI

Acabado pantalla / Shade colour



BL

Opciones metal / Metal options



CR



NI

Suelo/Floor Lamp // 5392 >

Acabado pantalla / Shade colour



BL

A man is sitting on a dark blue sofa, reading a book. A modern floor lamp with a white conical shade is positioned next to him, casting a warm glow. The lamp has a long, thin, adjustable neck that arches over the sofa. The background shows a window with blinds.

PALM

design 2009

technical data

253

Una base en forma palmípeda sostiene un fuste inclinado regulable en altura. Palm recuerda a la esbelta pata de una garza volcando la luz a una altura óptima en tu butaca favorita. Realizada en metal níquel satinado o brillo y con pantalla algodón opaco de sección cónica.

With its web-footed base supporting a gently inclined rod that can be adjusted for height, Palm is reminiscent of the slender legs of a graceful water bird. It is the perfect reading lamp, ideal next to a sofa or armchair. Available in a brushed or shiny nickel finish, Palm comes with a cone-shaped shade made of opaque cotton.

102

ATRIUM

design 2006

technical data

253

Esta pieza de contundente dimensión se construye en torno a su brazo articulado, de tramo único y en ángulo inclinado, que dibuja su elegante geometría. La rótula en el eje vertical del fuste proporciona una mejor orientación. Todo el beneficio de una articulación precisa, con pantalla tradicional en cotton opaco blanco.

Its dramatic dimensions and single-tranche articulated arm give Atrium a bold geometric look. The inclined shaft houses a pivoting axis to direct the light with more precision. The lamp comes with a traditional opaque shade in white cotton.



Suelo/Floor Lamp // 5389

Acabado metal / Metal colour

Acabado pantalla / Shade colour



CR



BL



104 HOLD

design 2008

technical data

253

Hold es una mesita auxiliar con lámpara incorporada o viceversa, una sencilla y actual revisión del clásico velador de madera con luz. Reduciendo la forma de este eterno mueble auxiliar a la esencia máxima, funciona tanto como mesilla de noche, al lado de la cama, o como mesilla de salón, al lado del sofá. Hold es honesto y cumple con su función. Se presenta en dos acabados de estructura, cromo y blanco, y cuatro opciones de mesita, haya, wengue, cristal y blanco. La pantalla es de cotton blanco.

Depending on how you look at it, Hold is a table-lamp or a lamp-table, a deft update of the classic wooden side table complete with its own light. Perfect to use next to a bed or armchair. Hold fulfills its role with simple elegance. The lamp is available in a chrome or white finish, with four finishing options for the table: wengue, beech, white, or glass. The shade is made of white cotton.



Suelo/Floor Lamp // 5382

Opciones Mesita / Table options



BL

CRISTAL

NAT

WE

Opciones metal / Metal options



BL

CR

Acabado pantalla / Shade colour



BL





108 QUASAR

design 2008

technical data

254

Quasar es la mínima expresión de la tradicional pantalla, ya sea en formato colgante o bien aplique de pared. Toma forma de una velluda tela de pelo corto y denso, cuyos hilos se distribuyen ofreciendo una sensación de suave profundidad y elegancia. El discreto lujo del terciopelo se presenta en tres colores, crudo, gris y negro, así como níquel satinado en los florones y cuerpos del aplique.

Quasar is a minimalist expression of the traditional lampshade, whether as a pendant lamp or wall sconce. Made with a shaggy cloth with short-haired fibers, this lamp has a plush, elegant look. The discreet luxury of this velvet lamp is available in beige, grey, or black; the metal base comes in brushed nickel.



^ Pared/Wall Lamp // 1651

^ Pared/Wall Lamp // 1646

^ Pared/Wall Lamp // 1645

Suspensión/Ceiling Lamp // 6933 -50/70

Acabado metal / Metal colour



NI

Opciones pantalla / Shade options



CR



GR



NE



110

technical data

254



Plafon/Plafond Lamp // 3462 -40/45/50/60/70

Opciones pantalla / Shade options





112 BUBLE

design 1970

technical data

253

Buble fue reeditada en el 2008, un clásico de nuestro catálogo creado en 1970. Gracias a su diseño arbolado que le confiere dinamismo a la esfera y su simplicidad, Buble es una pieza absolutamente actual y moderna. De estructura tubular en acabado cromo o cobre extrabrillo soporta las esferas en vidrio opal. Esta reedición de los años 70 es una de las más antiguas de nuestro catálogo y sin duda un básico en proyectos de interiorismo en cualquiera de sus tres versiones.

Buble is an updated version of our original 1970s design. A modern lamp with a simple tree-shaped design, Buble has a tubular base, available in chrome or copper finishes and fitted with opal glass spheres instead of traditional lampshades. This 2008 version is an update of one of our oldest models; in any of its three versions, it adapts to numerous settings.



^ Suspensión/Ceiling Lamp // 6138

Opciones metal / Metal options



CR

CO

Acabado Cristal / Glass colour



OP-MT

^ Suspensión/Ceiling Lamp // 6140

Suspensión/Ceiling Lamp // 6139 >



116 TANSHA

design 2016

technical data

254

Tansha es iconográfica en su forma y esencial en su función. Si dibujáramos un arquetipo de lámpara, probablemente dibujaríamos la silueta de esta discreta y evocadora pieza. Realizada en metal cromado en su estructura y con tulipa de cristal ácido o transparente, Tansha aportará una iluminación ambiente discreta e intimista.

Tansha is iconographic in both form and function. In fact, if one were asked to draw the archetype of a lamp, the result would probably resemble the discreet, evocative Tansha silhouette. With a structure made of chrome-plated metal topped with an acid-treated or clear glass shade, "Tansha" provides intimate, elegant lighting in any setting.



Mesa/Table Lamp // 4403

Suspensión/Ceiling Lamp // 6803

Acabado metal / Metal colour

Opciones cristal / Glass options



CR



TR



MT



118 ATHINA

reedition 2016

technical data

254

Athina combina el acero brillante con la tela de una pantalla cilíndrica de sujeción interna que parece flotar en el aire, mientras su sombra proyectada en la base la afianza en el suelo. Athina es una colección de lámparas con un marcado acento contemporáneo que se presenta en níquel satinado o grafito satinado y pantalla retorta lisa o plisada.

Athina combines a polished steel base with a cylindrical cloth shade that seems to float in the air while the play of light and shadow firmly grounds the structure. Athina is a contemporary collection of lighting fixtures available in brushed nickel or graphite finishes; the cream-colored cotton shade also comes in a pleated version.



Mesa/Table Lamp // 4456

Opciones metal / Metal options



Suelo/Floor Lamp // 5456

Opciones pantalla / Shade options





120 MARSALA

design 2011

technical data

254

Marsala es concebida como iluminación general para espacios amplios ya que aunque ligera de estructura, sus dimensiones son considerables. Elevada en una perfilera tubular muy fina y adornada por dos contrapesos esféricos suspendidos en el espacio central, Marsala consigue crear una atmósfera de luz cálida y envolvente. Se presenta en cuerpo blanco mate texturado y tres colores de pantalla de algodón: marsala, blanco roto y negro.

Marsala has been designed with an airy look and generous dimensions to provide overhead lighting for large spaces. Elevated on a tubular frame with two decorative counterweights in the center, this lamp creates a warm atmosphere with a captivating light. Marsala has a matte white body and three options for the cotton shade: Marsala red, matte white, and black.

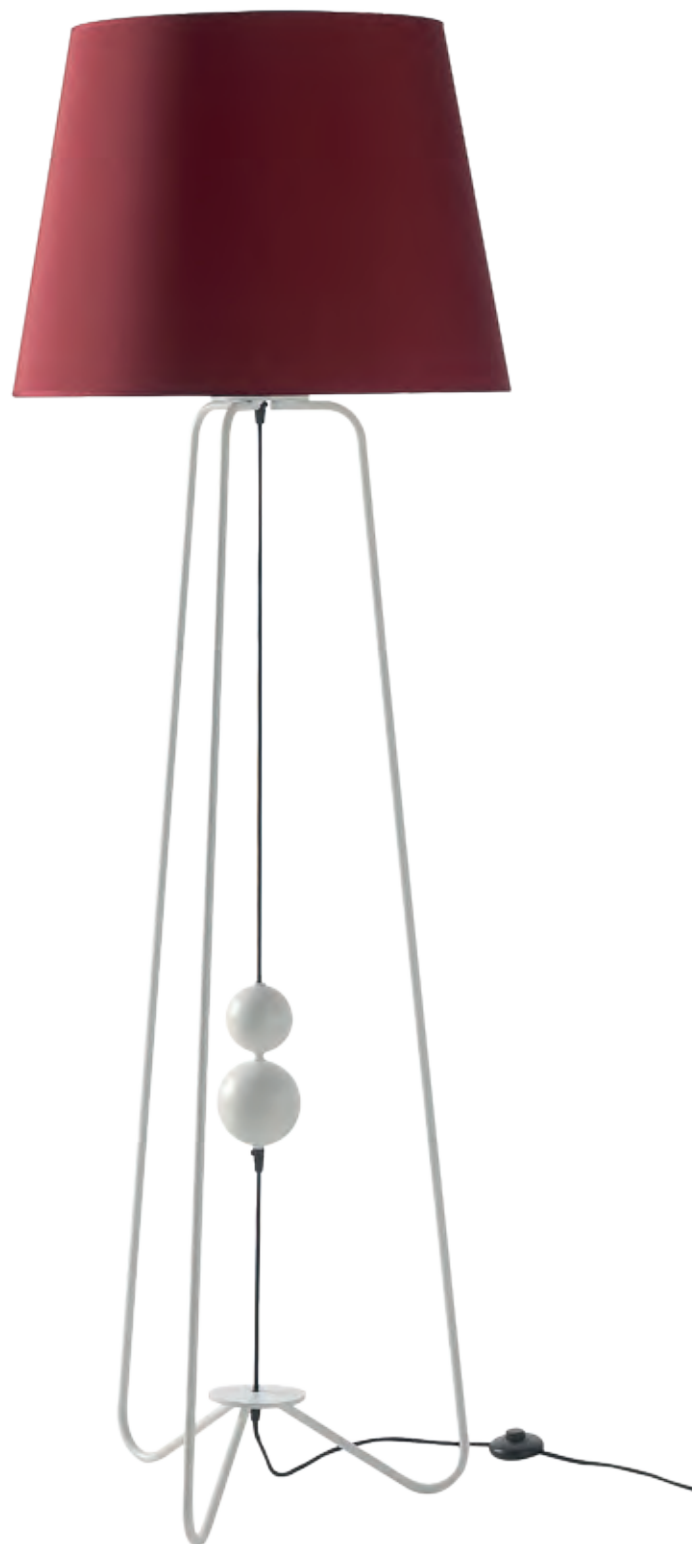

Suelo/Floor Lamp // 5367

Acabado metal / Metal colour



BL-MT

Opciones pantalla / Shade options



BL



NE



RO





122

VERSUS

design 2012

technical data

255

Inicialmente creamos una lámpara de suspensión pensada para proyectos que requieran dimensiones XXL, así nació Versus. Luego la familia creció. Su pantalla de cinta de seda colocada artesanalmente está disponible en cuatro colores. En las versiones de aplique, sobremesa y pie, el metal será blanco brillo, níquel satinado o negro mate según su versión. Apagada posee una atractiva presencia y encendida propaga una luz rica en matices.

Versus was initially designed as a ceiling lamp for spaces that require an extra-large lighting fixture. Later, the collection was expanded to include a table lamp and a floor lamp. The handmade shade is made of silk ribbon and comes in four colors. For the wall sconce, table lamp and floor lamp the metal base comes in glossy white, brushed nickel or matte black. Even when switched off, Versus is an attractive fixture; switched on it emanates a nuanced light.



Pared/Wall Lamp // 1400

Suspensión/Ceiling Lamp // 6937 -60/80/100

Mesa/Table Lamp // 4400

Plafón/Plafond Lamp // 3400

Suelo/Floor Lamp // 5400

Opciones metal / Metal options



BL NE-MT NI

Opciones pantalla / Shade options

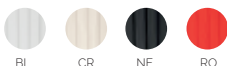

BL CR NE RO



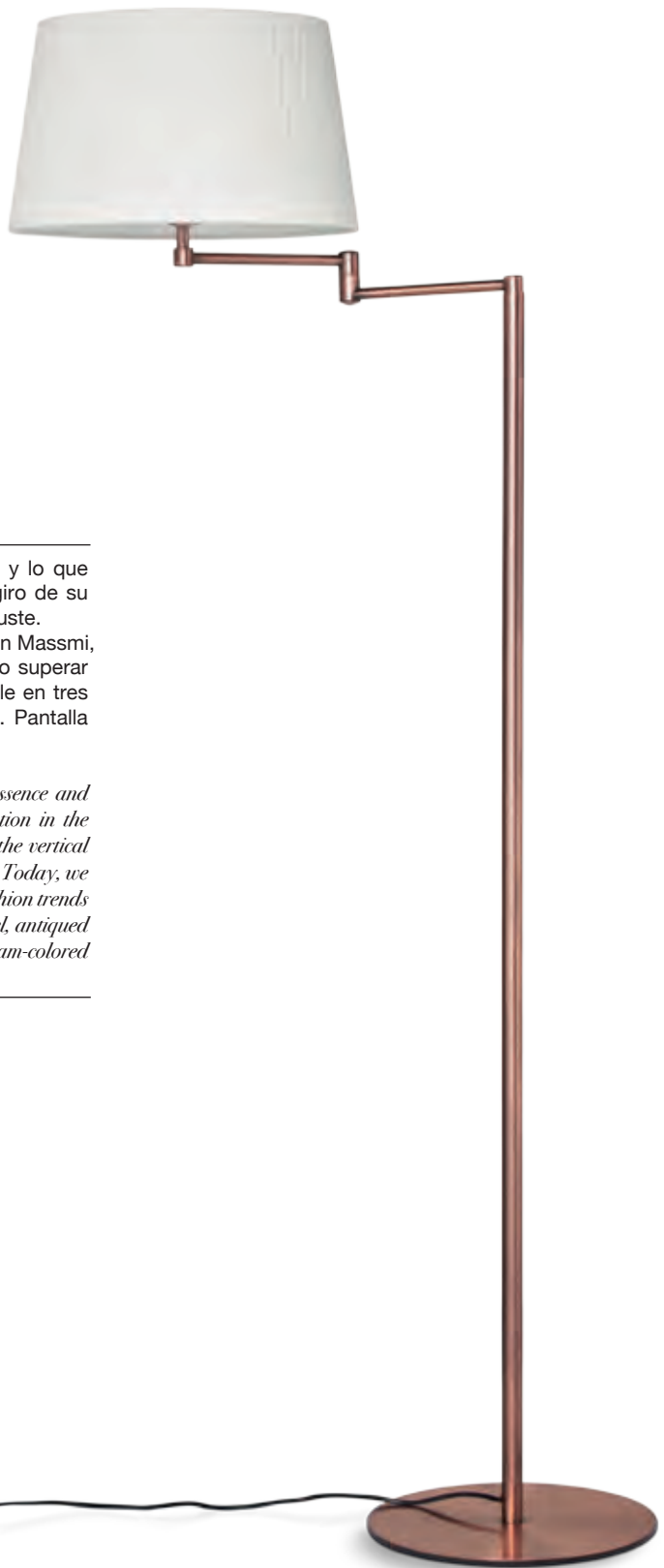

124 GIRA

design 1990

technical data

255

Inspirada en un diseño de 1950, la esencia funcional y lo que define la geometría básica de Gira está en el doble giro de su brazo articulado por la mitad y en ángulo recto con el fuste. Esta colección se comenzó a fabricar en los años 90 en Massmi, nos sentimos orgullosos de ella porque ha conseguido superar las tendencias y encontrar siempre su lugar. Disponible en tres acabados, níquel satinado, cuero envejecido y cobre. Pantalla plisada en algodón crudo.

Inspired by an original design from 1950, the functional essence and basic geometry of Gira revolves around the double articulation in the middle of the pivoting arm, positioned at a right angle from the vertical axis. Massmi began to manufacture this collection in the 1990s. Today, we continue to be proud of Gira for the way it has risen above fashion trends to find its place among the classics. Available in brushed nickel, antiqued brass, and copper finishes, with a shade made of pleated cream-colored cotton.



Pared/Wall Lamp // 1150 (2 articulaciones/double-articulated)
Pared/Wall Lamp // 1149 (1 articulación/articulated)

Mesa/Table Lamp // 4157

Suelo/Floor Lamp // 5133

Opciones metal / Metal options



Acabado pantalla / Shade colour





LORY

design 1975

technical data

255

Las dos versiones de Lory son un clásico en el corazón de nuestro catálogo. De aire tradicional y romántico. Está realizado con tubo de cuero envejecido. Lory es perfecta para crear una zona de lectura o añadir una luz extra en un punto concreto, gracias a su brazo en arco regulable en altura, se adaptará con facilidad como foco de luz más localizado que creará un espacio cálido y acogedor allá donde esté.

Both versions of Lory occupy an important place in our catalogue thanks to their traditional, romantic air. Lory is perfect for creating mood lighting or adding an extra point of light in any setting. Its tubular structure of antiqued brass and its pivoting arm make it both functional and elegant.

^ Suelo/Floor Lamp // 5166

Acabado pantalla / Shade colour



RE

Suelo/Floor Lamp // 5165 ^

Acabado pantalla / Shade colour



CR

Acabado metal / Metal colour



PV

126

AMPORDÁ

design 1994

technical data

256

Ampordá bien puede haber salido de una de las grandes casonas de la campiña inglesa llenas de muebles usados, aquellos que se volvían a pintar una y otra vez recreando una apariencia relajada y romántica. Ampordá se presenta en tres colores de acabado en su estructura, marfil, marrón y negro. La pantalla cónica es de algodón retorta.

Ampordá looks like it could have come from an English country cottage full of antiques that have been painted again and again to give them a relaxed, romantic air. Available in brown, ivory, and black. Ampordá comes with a cone-shaped shade made of cream-colored canvas.



Pared/Wall Lamp // 1507 (1/2 luces/lights)

^ Suspensión/Ceiling Lamp // 7941 (3/5 luces/lights)

Opciones metal / Metal options



Acabado pantalla / Shade colour



Mesa/Table Lamp // 4154

Suspensión/Ceiling Lamp // 7942 (3/5 luces/lights) >





128

TOULOUSE

design 1994

technical data

256

Toulouse, de sabor tradicional, combina la forja con el cristal opal de sus tulipas. La tendencia actual es volver a lo antiguo, así como mezclar estilos, Toulouse le aporta a tu casa una personalidad muy propia con un look nostálgico.

Toulouse combines wrought iron with opal glass to create a traditional look. Totally in step with the current trend to recycle antiques and mix different styles, Toulouse lends a nostalgic look full of personality to any space.



Suspensión/Ceiling Lamp // 7870 (3/5 luces/lights)



Suspensión/Ceiling Lamp // 7872 (3/5 luces/lights)



Pared/Wall Lamp // 1410 (1/2 luces/lights)



Pared/Wall Lamp // 1548 (1/2 luces/lights)



Opciones metal / Metal options



Acabado cristal / Glass colour





LOMBARDÍA

design 2000

technical data

255

Lombardía nos trae el recuerdo de la vieja buhardilla de la abuela, la recuperamos en honor a esas piezas injustamente olvidadas. De formas suaves y redondeadas, Lombardía es la esencia de un estilo natural que conserva la belleza de los objetos antiguos.

Lombardía is reminiscent of grandmother's attic, full of wonderful, forgotten items that deserve to be recovered and vindicated. With its rounded forms, this family of lamps evokes the essence of a natural style that is characteristic of the beauty of antique pieces.



Suspensión/Ceiling Lamp // 7873

Pared/Wall Lamp // 1140

Acabado pantalla / Shade colour

Opciones metal / Metal options



RE



MA



MF



NE-MT



130 KARENINA

design 2004

technical data

257

Karenina nos acerca al diseño rústico contemporáneo, y uno de los estilos más elegantes y evocadores de esta tendencia es el shabby chic, un estilo que combina con otros como el rústico o el romántico. Su diseño aporta calidez y un toque dulce y femenino. Karenina está disponible en tres acabados y su elegante pantalla piramidal está realizada en yute crema.

Karenina is an example of contemporary rustic design, a trend with many different styles. One of the most evocative of these is known as "shabby chic," a style that combines with both rustic and romantic settings. Karenina adds warmth and a feminine touch to this type of space. Available in three finishes with a pyramid-shaped shade made of cream-colored jute.



Pared/Wall Lamp // 1630 (1/2 luces/lights)

Opciones metal / Metal options

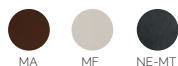

Acabado pantalla / Shade colour



Mesa/Table Lamp // 4262

Suspensión/Ceiling Lamp // 7221 >





134

BERKA

design 2016

technical data

257

La colección Berka en sus diferentes versiones de pie, colgante y sobremesa encaja a la perfección en interiores nórdicos, lofts eclécticos y ambientes neoclásicos o bohemian chic, es absolutamente versátil. Su marcada pantalla cónica está terminada con una pieza de madera de haya torneada que le confiere una estética muy contemporánea, sencilla y elegante. Realizada en hierro acabado blanco mate texturado, negro mate texturado u oro brillo. Base y remates en madera de haya para el sobremesa y el pie de salón.

The Berka collection includes a floor lamp, a pendant, and a table lamp. These versatile lamps fit perfectly in any setting, from those with a Nordic feel, to eclectic or shabby chic lofts. The cone-shaped shade has a beechwood finial to lend a contemporary air to these simple, elegant fixtures. Made of iron and available in matte white, matte black, or glossy brass finishes, the floor and table lamp models incorporate wooden accents in both the base and the finial.



Suspensión/Ceiling Lamp // 6983

Mesa/Table Lamp // 4433

Suelo/Floor Lamp // 5433

Opciones metal / Metal options

Acabado madera / Wood colour

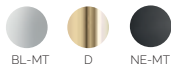





136

MISTYC

design 2012

technical data

256

Mistyc renueva la tradición de las luminarias centrales que iluminan los espacios con luz directa. Su aire futurista y elegante consigue una luminaria de aspecto leve y presencia sobria, que difunde una luz cenital cálida y homogénea. Está disponible en dos acabados de metal, negro y blanco texturado con cable textil rojo.

Mistyc brings back the tradition of central ceiling lamps and direct lighting. Its elegant, futuristic air gives this lamp an airy, yet sober feel as it gives off a warm, uniform light. Available in two metal finishes, matte black or white; the cord is made of red cloth.

Suspensión/Ceiling Lamp // 6970

Opciones metal / Metal options



BL-MT



NE-MT



POPPOL

design 2016

technical data

256

Poppol se presta al juego compositivo de lámparas de suspensión con dos formatos de pantallas y dos colores, negro o blanco mate texturado que multiplican la utilidad de esta sencilla cúpula luminosa. Su estilo nórdico lo acentúa el remate torneado en madera de haya, que contrasta con el negro y se dulcifica en el blanco.

With two lampshade shapes and two colors, matte white or matte black, the texturized surface of this simple dome-shaped pendant lamp permits numerous possibilities for combinations. The beechwood accents heighten its Nordic styling, making a stark contrast in the black version and softening the look in the white one.

Suspensión/Ceiling Lamp // 6984



Suspensión/Ceiling Lamp // 6985



Opciones metal / Metal options



BL-MT



NE-MT

138

BOBBY

design 2012

technical data

257

Bobby se compone de dos formatos de colgante, disponibles en tres acabados a elegir y con los que jugar a crear composiciones. Es una pieza casi ingenua en su silueta y pragmática en su función, pero a veces, ¿quién quiere pedirle mucho más a una lámpara?.

Bobby is a collection of pendant lamps that comes in two models and three different finishes. It is perfect for creating playful compositions. The design is almost naive, simple and practical at same time. Then again, sometimes less is more in a lighting fixture.

^ Suspensión/Ceiling Lamp // 6972

Opciones metal / Metal options



BL-MT CO NE-MT

Suspensión/Ceiling Lamp // 6952 ^

Opciones metal / Metal options



BL CO NE-MT



CLUB *element*

restyling 2016

technical data

257

Club element es la versión básica de esta colección atemporal, sencilla y muy versátil. Dará un toque especial tanto en espacios públicos, cafés y restaurantes, como privados. Una apuesta segura tanto individual como creando conjuntos con sus distintos tamaños y acabados. Se presenta en tres colores, blanco o negro mate texturado y oro brillo, además de en tres tamaños de colgante.

Club element is the basic version of this collection, simple and very versatile. It lends a special touch to public spaces such as coffee shops and restaurants, but is also perfectly at home in more intimate settings. This lamp can be used individually or to create compositions with different sizes and colors. Available in three sizes and in three different finishes: matte black, matte white, or glossy brass.



Suspensión/Ceiling Lamp // 6986 -17/30/38

Pared/Wall Lamp // 1616

Opciones metal / Metal options



BL-MT D NE-MT

140 HAT

restyling 2012

technical data

258

Hat se inspira en uno de los estilos más relevantes del diseño de mediados del siglo XX, el modernismo californiano. Hat aúna así vanguardia y clasicismo lo que la convierte en una pieza atemporal. El soporte trípode tubular del pie está inclinado hacia atrás. La pantalla se orienta desde una rótula que puede ser direccionada allí donde sea necesaria la luz. Disponible en tres acabados, cobre, blanco y negro; tanto en su versión pie como colgante.

Hat is inspired by one of the most important design styles of the mid-twentieth century, California Modernism. This combination of vanguard style and classicism make Hat a timeless piece. The tripod-shaped tubular base inclines slightly backwards, with the articulated axis allowing for full adjustment of the shade. Available in copper, white, and black finishes for both floor and pendant lamp models.



Suelo/Floor Lamp // 5383

Suspensión/Ceiling Lamp // 6953 >

Opciones metal / Metal options







142

SPIDER

design 2012

technical data

258

Spider toma su forma de las patas de una araña. Su estructura metálica curvada integra, bien una tulipa en cristal opal que impide el deslumbramiento y genera un efecto de luz matizada, bien para los más atrevidos, una bombilla globo al desnudo para una iluminación más abierta. Asegurando un ambiente cálido y moderno.

The design structure of Spider takes its inspiration from the actual arachnid. The curved metal structure can incorporate either an opal glass to create a filtered light without glare or a bare bulb for a brighter light. Both create a warm, modern atmosphere.

Suspensión/Ceiling Lamp // 6945 (versión bombilla/bulb)

Suspensión/Ceiling Lamp // 6944 (versión cristal/glass)

Opciones metal / Metal options





144 BABE

design 2012

technical data

258

Small office o lo que es lo mismo SoHo. Así han bautizado en EEUU la tendencia (un verdadero lujo) de trabajar en casa. Babe es nuestra aportación a ese ímpetu de intimidad laboral, revisando el clásico flexo de trabajo. Una versión fresca y con cierto aire pop, que dará un toque divertido al escritorio o acompañará tus lecturas junto a la butaca.

Whether it is called a small office or SoHo, this is the name used in the USA for the trend of working from home, the new luxury. Babe is our contribution to this new way of working, an update of the classic flex lamp. This fresh, new version, with its air of pop art, adds an amusing focal point to any desk or reading nook.



Mesa/Table Lamp // 4402

Suelo/Floor Lamp // 5402

Opciones metal / Metal options



BL

NE-MT

RO

VE



MINIMATE

design Nacho Timón 2013

technical data

258

Uno de los objetivos más complejos en el diseño siempre ha sido llegar a la simplicidad absoluta, dejando únicamente la esencia del objeto útil y bello. De esta búsqueda surge Minimate, que resulta del plegado de una superficie plana que conforma la base y el cuerpo, al que se le incorporan dos pantallas también plegadas y posteriormente soldadas. Minimate está disponible en seis colores, un guiño al humor y el colorido de las emociones que evocan los pequeños objetos.

One of the more difficult aims of contemporary design has always been to obtain absolute simplicity while maintaining the essence of the object. Minimate comes out of this search for equilibrium. The base of the lamp is the result of pleating a flat surface; this is topped with two pleated shades welded together. Minimate is available in six colors, a nod to the humor and color of the emotions evoked by the small things in life.



Mesa/Table Lamp // 4423

Opciones cable / Wire options



Opciones metal / Metal options



146

AURA

design 2016

technical data

258

Aura destaca por un innegable aspecto escultórico acentuado por el uso del pan de oro o de plata sobre vidrio. Un globo de cristal con corte inferior para reflejar una luz llena de matices y efectos lumínicos. Ideal para crear composiciones que realcen una estancia espaciosa y a diferentes alturas para aumentar el efecto de la composición. ¡A partir de ahora no querrás apagar la luz de casa!

Aura has an undeniably sculptural look enhanced by the use of gold or silver leaf on the glass. The glass sphere is cut on the bottom to give off a more nuanced light. This lamp is perfect for creating compositions to add character to a large space, especially when hung in groups with each lamp at a different height. You may not want to switch the lights off ever again!



Suspensión/Ceiling Lamp // 6602 -20/25/30

Opciones metal / Metal options



Opciones cristal / Glass options

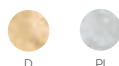



148

COCO

design 2016

technical data

259

Coco en su ligereza visual genera un resultado delicado y casi poético. El coloreado del vidrio le da un aspecto muy natural y están disponibles en blanco, fumé, verde y terracota crema. Encajará muy bien en espacios sencillos y depurados otorgándoles un tamizado de luz muy acogedor.

With its airy look, Coco creates a delicate, almost poetic effect. The color of the glass gives "Coco" a fresh and natural air. Available in white, smoke, green, and terracotta cream, it is the perfect lamp for simple spaces.



^ Suspensión/Ceiling Lamp // 6607

Opciones cristal / Glass options



Acabado madera / Wood colour



Suspensión/Ceiling Lamp // 6608 >



Suspensión/Ceiling Lamp // 6609 >

Acabado cristal / Glass colour





150

GLASSY

design 2016

technical data

259

Glassy recuerda a los sombreros que usan los campesinos en China y Japón. La combinación de líneas sencillas, el vidrio opal y los remates en madera de haya le confieren una estética muy discreta y moderna, con cierto sabor entre nórdico y japonés. El formato cónico está disponible en único acabado blanco opal y el modelo acampanado en blanco opal o fumé.

Glassy is reminiscent of the cone-shaped hat worn by traditional Chinese and Japanese farmers. The combination of simple lines with opal glass and wooden accents gives this lamp a discreet and modern feel. The cone-shaped version is only available in white; the bell-shaped version also comes in smoke-colored glass.



Suspensión/Ceiling Lamp // 6606 -P



Suspensión/Ceiling Lamp // 6606 -G



Acabado cristal / Glass colour



OP-MT

Acabado madera / Wood colour



HA

Suspensión/Ceiling Lamp // 6605



Opciones cristal / Glass options



OP



FU



152

LOFT

design 2016

technical data

259

Loft es una versión en cristal de las grandes lámparas de metal que se usaban en las fábricas de principios del s.XX. Una luminaria muy actual, que destila al mismo tiempo un aire delicado e industrial. Se presenta en dos tamaños y dos acabados, blanco opal o fumé.

Loft is a glass version of the big metal light fixtures used in factories in the early twentieth century. An extremely contemporary lamp, Loft combines an airy look with industrial flair. Available in two sizes and two colors, opal white and smoke.



Suspensión/Ceiling Lamp // 6611 -25/30

Opciones cristal / Glass options



OP



FU

Acabado metal / Metal colour



NI



PIPPA

design 2016

technical data

259

Pippa está concebida para crear composiciones divertidas, colocándola en grupo a distintos niveles o de manera lineal. Realizada en vidrio centrifugado transparente, se completa con un remate cónico en madera torneada de haya en dos tamaños, y cable eléctrico de colores, que constituyen el gesto diferenciador.

Pueden ir en cualquier espacio o ambiente de tu casa, desde la cocina al estudio o el baño, en espacios públicos como restaurantes y tiendas.

Pippa is designed to combine and create light-hearted compositions by hanging several lamps grouped together or in a straight line, either all at the same height or at various heights. Made of clear spin glass, the lamp is topped with a cone-shaped finial carved in beechwood and available in two different sizes. The electrical cord is multicolored, marking the difference between this lamp and more conventional fixtures. These lamps can be installed anywhere in the home, whether it be the kitchen, bathroom, or study. It is also suitable for public spaces, like restaurants or shops.

Suspensión/Ceiling Lamp // 6610 -P



Suspensión/Ceiling Lamp // 6610 -G



Opciones cable / Wire options

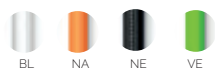

BL

NA

NE

VE

Acabado madera / Wood colour



HA

Acabado Cristal / Glass colour



TR

154 MARS

technical data

259

design 2016

Mars es sencillamente encantadora, llena de textura como el planeta Marte, que es justamente la idea de dónde surge el nombre. El vidrio está repleto de burbujas que logran un exquisito y delicado efecto. Mars se presenta en dos formatos de cristal y dos colores, transparente y ambar.

Mars is simply lovely, full of texture, just like the planet Mars. The glass shade is full of air bubbles to create a special, delicate effect. Mars is available with two sizes, either in transparent or amber glass.



Suspensión/Ceiling Lamp // 6604



Suspensión/Ceiling Lamp // 6603



Opciones cristal / Glass options

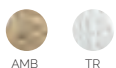

AMB

TR

Acabado madera / Wood colour



HA





158 SIMPLICITY

design 2009

technical data

260

Simplicity es lo que se llama en el mundo de la moda un buen "fondo de armario", piezas insustituibles de líneas sencillas que nunca fallan. Esta colección es tan versátil que se adapta a muy diferentes estilos. Disponible en níquel satinado, varios tamaños de plafón y colgante, así como dos tipos de pantalla: retorta o plisada crema o negra. Su versión aplique de pared se presenta en tres formatos distintos.

In the fashion world, the Simplicity line of lamps would count as "wardrobe essentials", those irreplaceable pieces with simple lines that go with anything. This versatile collection of lighting fixtures fits into any setting and design style. Available in a satin nickel finish and in several sizes for both the flushmount and pendant options, Simplicity also comes with two different shade styles. The wall sconce model has three different shapes to choose from.



Plafón/Plafond Lamp // 3465 -40/45/50/60/70

Mesa/Table Lamp // 4364

Acabado metal / Metal colour

Opciones pantalla / Shade options



NI



CR



NE



RE





Suspensión/Ceiling Lamp // 6920 -100

Opciones pantalla / Shade options

A  
PLISADO /
PLEATING CR NE

B   
TERCIOPELO /
VELVET CR GR NE

C   
ALGODÓN /
COTTON CR NE RO

D 
RETORTA /
COTTON RETORTA RE

160

technical data

260



Suspensión/Ceiling Lamp // 6921 -35/50/60/70

Pared/Wall Lamp // 1655

Acabado metal / Metal colour

Opciones pantalla / Shade options



NI



CR



NE



RE



^ Pared/Wall Lamp // 1673

^ Pared/Wall Lamp // 1668

Suspensión/Ceiling Lamp // 7921

Opciones pantalla / Shade options

Acabado metal / Metal colour

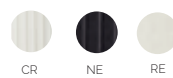

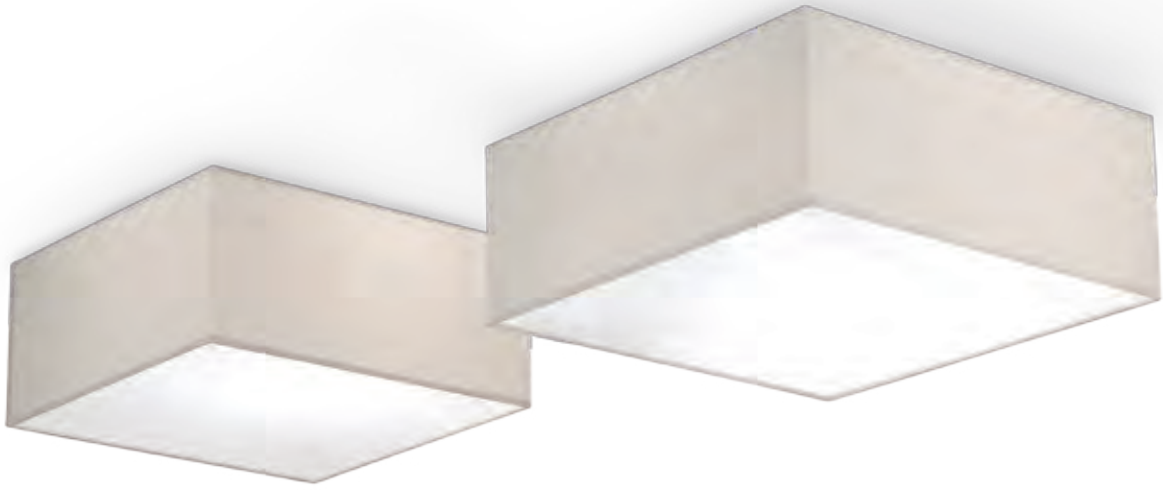

162 QBOX

design 2009

technical data

260

Qbox se compone de plafones de techo y apliques de pared de estructura cuadrada, elemental y elegante, piezas discretas que pueden ser colocadas individualmente o formando composiciones. Realizada en níquel satinado y algodón retorta liso o plisado, disponible en crema o negro. Tres medidas en su versión plafón y dos medidas en el aplique.

The Qbox collection comes either in a flushmount version or as a wall sconce, both with a simple square structure that is at once basic and elegant. These discreet fixtures can stand alone or be used together to form various compositions. The collection has a satin nickel finish with a beige cotton shade, which also comes with a pleated option in white or black. There are three sizes for the flushmount model and two for the sconce.



^ Pared/Wall Lamp // 1663 -25/30 (LED)



^ Pared/Wall Lamp // 1654 -25/30

Plafón/Plafond Lamp // 3466 -35/40/50

Acabado metal / Metal colour



NI

Acabado pantalla / Shade colour



RE

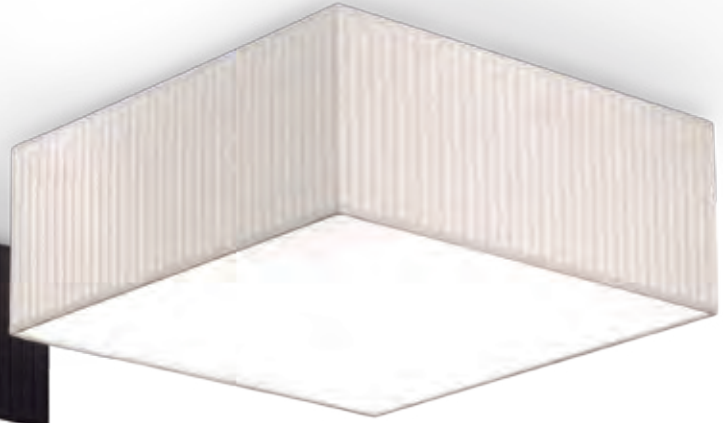

Pared/Wall Lamp // 1662 -25/30

Plafón/Plafond Lamp // 3468 -35/40/50

Opciones pantalla / Shade options

Acabado metal / Metal colour



CR

NE



NI



164 DONA

design 2004

technical data

259

Dona se caracteriza por la contundente presencia de sus pantallas de grandes dimensiones y formatos rectangulares. Existen dos versiones, cúbica y piramidal. Ambas elegantes y básicas que combinan en cualquier ambiente. Disponible en dos acabados de pantalla en la versión cúbica y un único acabado en la piramidal.

Donna is a pendant lamp with dramatic geometric forms and large-scale dimensions. There are two versions, cube-shaped and pyramid shaped. Both lend a simple, elegant air to any setting. The pyramid-shaped model comes in one color; the cubed-shape models are available in two color choices.

^ > Suspensión/Ceiling Lamp // 6828

Opciones pantalla / Shade options

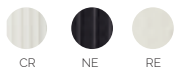

CR

NE

RE

Acabado metal / Metal colour



NI

^ Suspensión/Ceiling Lamp // 6827

Acabado pantalla / Shade colour



RE





166

SATIN

design 2011

technical data

261

Satin es un claro ejemplo de un producto contemporáneo y atemporal que se adapta a cualquier ambiente o aplicación. Nosotros sentimos debilidad por la textura de su pantalla, con un sutil brillo crema o gris perlado que le otorga distinción aún siendo una pieza muy elemental y versátil. Perfecta para crear contrastes en la decoración. Está disponible en metal acabado blanco brillo o negro mate y en dos tamaños en su versión plafón y cuatro en su versión colgante.

Satin is a clear example of a timeless, yet contemporary lighting fixture that harmonizes with any setting. The texture of the shade in either a subtly glossy cream or pearly grey endows this fixture with distinction while maintaining its simple versatility. Perfect for creating contrasts in any type of decor, Satin is available in a glossy white or black matte finish, with two sizes for the flushmount model and four sizes for the pendant lamp version.



Suspensión/Ceiling Lamp // 7257 (3 pantallas/shades)

Mesa/Table Lamp // 4377

Suspensión/Ceiling Lamp // 6927 -35/50/60/70 (1 pantalla/shade)

Plafón/Plafond Lamp // 3489 -50/70 >

Opciones metal / Metal options

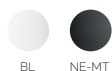

BL

NE-MT

Opciones pantalla / Shade options

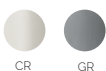

CR

GR





168

TEX

design 2011

technical data

261

Tex está especialmente concebida para su aplicación en proyectos contract, realizada en algodón, tejido técnico lamitex y acrílico. El lamitex es un tejido técnico con unas características que lo hacen muy fácil de limpiar y con una larga vida útil en perfectas condiciones, además de tener una textura tableada que le da un aspecto de tejido muy elegante y atemporal. Disponible en formatos xxl, que confieren una presencia espectacular en espacios públicos como hoteles, restaurantes y comercios. Se presenta en blanco o negro acrílico o algodón, así como en blanco nude en el caso del lamitex.

is specially designed for use in major construction projects and is made of modern materials such as acrylic and lamitex, an engineered material that is both low maintenance and long life. Its pleated texture endows this material with a timeless elegance. Tex is available in XXL sizes to lend a dramatic air to public spaces such as hotels, restaurants, or shops. Available in glossy black or white acrylic finishes; lamitex models come in semi-matte white.



^ Plafón/Plafond Lamp // 3480 -40/50/60/70

Opciones versión Acrílico / Acrylic shade options



Plafón/Plafond Lamp // 3486 -40/45/50/60/70

*Opciones versión Algodón / Cotton shade options



*Sin fotografía / without imagen

^ Plafón/Plafond Lamp // 3490 -50/70
Suspensión/Ceiling Lamp // 6935 -35/50/80 >

Acabado versión Lamitex / Lamitex shade colour





170 TRIPP *Hotel*

reedition 2016

technical data

260

Las Tripp están realizadas con tubo redondo en el pie central y base en aspa metálica, en color blanco brillo. La pantalla es ligeramente cónica de algodón blanco, creando así una confortable atmósfera de luz. Una pieza muy actual y adaptable a todo tipo de ambientes modernos.

Tripp lamps are made with a round tube mounted in the center of a white, X-shaped, metal base. The shade is slightly cone-shaped and is made of white cotton to create a warm, comforting glow. With its contemporary design, Tripp is especially suited to settings with a modern decor.



Mesa/Table Lamp // 4321 (grande/big)

Mesa/Table Lamp // 4320 (peño/little)



Suelo/Floor Lamp // 5320

Acabado metal / Metal colour

Acabado pantalla / Shade colour



BL



BL



QUO *Hotel*

reedition 2016

technical data

261

Quo es una de las colecciones que nos acompaña desde el año 2006 y año tras año se posiciona en el ranking de nuestros básicos bestseller, por su versatilidad y alta calidad. Se caracteriza por sus pantallas y formatos cúbicos, un básico que aportará elegancia a cualquier espacio. Realizada con tubo cuadrado bañado en cromo brillo y pantalla cúbica de algodón retorta.

The Quo hotel collection of fixtures was added to our catalogue in 2006 and year after year they have been the best selling lamps from our Basics collection due to their versatility and high quality. The lamp frame is comprised of a metal tube in a chrome finish topped with a cube-shaped beige cotton shade.



Suelo/Floor Lamp // 5239

Mesa/Table Lamp // 4316 (grande/big)

Mesa/Table Lamp // 4315 (peño/little)

Acabado pantalla / Shade colour

Acabado metal / Metal colour



172

CHIC *Hotel*

design 2008

technical data

261

La colección Chic es una familia de lámparas de líneas estilizadas y un acentuado protagonismo de la pantalla. Uno de los mejores productos de nuestro catálogo, por su sencillez, su buen diseño y la excelente relación entre precio y calidad. Las lámparas Chic resultan ideales para crear ambientes amables donde se requiera una luz cálida. Se presenta en tubo redondo acabado níquel satinado y pantalla linón crema. En el apartado accesorios del catálogo encontrarán los pies sin pantalla para que puedan hacer la combinación que deseen.

Chic is a collection of slender, stylized lamps with the shade as the protagonist. With its simple design and excellent value, it is one of the most popular products of our catalogue. Chic lamps are perfect for creating settings with warm light. The lamps are made of a round tubular frame in a satin nickel finish topped with a beige linen shade. The "Accessories" section of this catalog shows the different types of floor lamps available without a shade to combine with a shade of the client's choosing.



Mesa/Table Lamp // 4120 (grande/big)

Mesa/Table Lamp // 4116 (peño/little)

Suspensión/Ceiling Lamp // 6120 -35/50



Suelo/Floor Lamp // 5120

Acabado metal / Metal colour

Acabado pantalla / Shade colour



NI



LI

PETIT *Hotel*

design 2016

technical data

262

Las Petit son unas pequeñas lamparitas, altas y estilizadas. Pensadas para acompañar en espacios donde queramos aportar un punto de calidez. Se adaptan con facilidad a cualquier espacio. Disponibles en dos tamaños, acabado níquel satinado y pantalla algodón retorta.

Petit is a family of elongated, stylized table lamps. Their small format makes them perfect for creating a warm, cozy nook in any space. Available in two sizes, the fixtures come in a satin nickel finish with a beige cotton shade.



Mesa/Table Lamp // 4435 (grande/big)

Mesa/Table Lamp // 4434 (peño/little)

Acabado pantalla / Shade colour

Acabado metal / Metal colour



RE



NI



174

VIENA

design 2004

technical data

262

Viena nos acerca al diseño rústico contemporáneo, posee una atractiva mezcla entre provenzal y chic parisien, que conferirá un estilo muy personal en espacios que buscan una estética ecléctica y actual. Realizada en tubo cuadrado acabado marrón chocolate y pantalla tiffanys en crema degradé con remate en cenefa geométrica.

Viena is a fine example of contemporary rustic design with its attractive mixture of Provencal and Parisian chic. The result is a highly personal style for settings aiming for an eclectic look. The lamp frame consists of a brown square rod topped with a cream-colored Tiffany shade with geometric trim.



Pared/Wall Lamp // 1661 (1/2/3 luces/lights)

Suspensión/Ceiling Lamp // 6812 -30/45 (1 luz/light)

Acabado metal / Metal colour



MA

Suspensión/Ceiling Lamp // 7183 (3/4 luces/lights)

^ Mesa/Table Lamp // 4254 (peño/little)

Mesa/Table Lamp // 4255 (grande/big)>



176

BÁSIC

design 2001

technical data

262

Básic es una familia de lámparas que reinterpreta con carácter actual y estilo minimalista la forja de toda la vida. También un clásico en nuestro catálogo que año tras año confirma su lugar. Las Básic realizadas en hierro marrón, marfil y negro mate son perfectas para mezclar en pequeñas dosis con otros estilos y materiales. La mezcla, en decoración casi siempre resulta enriquecedora. Pantalla en formato piramidal en algodón retorta.

Our Basic collection of lighting fixtures reimagines traditional wrought iron lamps, giving them a more contemporary feel and minimalist look. They are a perennial in our catalog and have retained their popularity through the years. The frames are made of brown, ivory, or black wrought iron, perfect for mixing with other styles and materials to lend any decor an eclectic touch. The pyramid-shaped shade is made of beige canvas cotton.



Mesa/Table Lamp // 4461 (peño/little)

Mesa/Table Lamp // 4462 (grande/big)

Suelo/Floor Lamp // 5161

Opciones metal / Metal options

Acabado pantalla / Shade colour

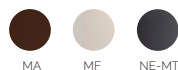

MA

MF

NE-MT



RE



^ Pared/Wall Lamp // 1461 (1/2/3 luces/lights)

^ Pared/Wall Lamp // 1462 (1/2/3 luces/lights)

Suspensión/Ceiling Lamp // 7161 (3/4 luces/lights)

Acabado pantalla / Shade colour

Opciones metal / Metal options



RE



MA



MF



NE-MT

178

BLANK

design 1997

technical data

263

La colección Blank es una reedición de su original creado en el año 1997, bajo la consigna de menos es más. Resulta una pieza elemental que conserva su estilo rústico provenzal con la que hemos iluminado todo tipo de espacios, desde hoteles y pequeñas casitas rurales, pasando por coffe shops, restaurantes, y todo tipo de ambientes rurales y urbanos. Blank, realizada en hierro acabado marrón, marfil o negro y con pantalla cónica algodón crema, ofrece una atractiva presencia ornamental que enriquece el entorno en el que habita.

Blank is a newer version of one of our original products created in 1997 with the "less is more" philosophy. The result is a simple lamp that conserves a hint of Provencal style. These lamps have been used to light all types of spaces - from hotels to small country cottages, cafés to restaurants - in any number of settings, both urban and rustic. The Blank lamps have a brown, ivory, or black wrought iron frame topped with a cone-shaped shade made of beige cotton and provide an attractive ornamental element that enriches any setting.



Pared/Wall Lamp // 1459

Suspensión/Ceiling Lamp // 7954 (3/5 luces/lights)

Opciones metal / Metal options



MA MF NE-MT

Acabado pantalla / Shade colour



CR



Mesa/Table Lamp // 4872



Suelo/Floor Lamp // 5208



180

NATURA

restyling 2016

technical data

262

Natura está realizada con una base abombada y un tronco central extrafino en relación a su altura de color blanco mate texturado. Una pequeña pantalla de algodón disponible en dos colores, gris perla y gris ceniza realza su estilismo. Natura representa el carácter pragmático de un diseño esencial que funciona a la perfección en múltiples rincones de nuestro hogar y espacios públicos. Incluye un tirador de apagado-encendido, un gesto funcional y diferenciador en este tipo de luminarias.

Our Natura lamps have a domed base with a texturized matte white pole that is extremely slender in proportion to its height. The small cotton shade is available in two colors, pearl gray or ash gray, both of which heighten the stylized effect. The Natura collection epitomizes the pragmatic nature of basic design and fits perfectly into a myriad of settings in both private and public spaces.

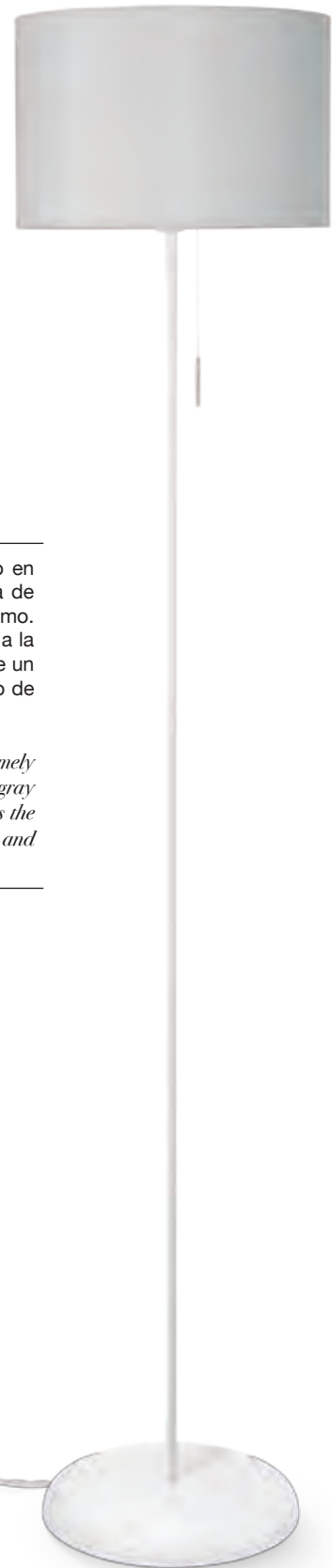

Pared/Wall Lamp // 1460

Mesa/Table Lamp // 4873

Suelo/Floor Lamp // 5209

Acabado metal / Metal colour

Opciones pantalla / Shade options



BL-MT



GR



GO



VALLISE

design 2016

technical data

263

Las Vallise tienen un aspecto de gran ligereza, pensadas y producidas como pieza simple, fácil y cercana. Tanto en su versión pie como sobremesa son lámparas de lectura que nos ofrecen una luz directa y a la vez ambiental a través de su pantalla cónica. La rótula que soporta su pantalla es orientable. Realizada en hierro acabado negro o blanco mate texturado, con pantalla en lino crudo.

Our Vallise lamps, with their airy look, are designed and manufactured to be simple, easy, and familiar. Both the table lamp and floor lamp are perfect for reading, but because of the cone-shaped shade, provide mood lighting as well as direct light. The lampshade is fully adjustable. The lamps have a black, white, or brown iron pole-shaped frame topped with a beige linen shade.



Suelo/Floor Lamp // 5436

Mesa/Table Lamp // 4436

Acabado pantalla / Shade colour

Opciones metal / Metal options



LI



BL-MT



NE-MT



182 CARRÁ

design 1997

technical data

263

Carrá es heredera del "modern style" inglés de principios del siglo XX. Un ejercicio de simplificación y combinación de lo clásico y lo moderno. Hecha en vidrio acabado opal mate. Carrá en su versión colgante dispone de un cable extensible que oscila de los 30cm a los 100cm aproximadamente, con un arco inferior diseñado para poder regular la altura de la lámpara.

The Carrá series was inspired by early twentieth century English style; the result is its simple combination of classic and modern elements. The shade is made of matte opal glass. In the pendant model, the cord can be adjusted from 30 to 150 cm, with a lower arc to help regulate the overall height.



Plafón/Plafond Lamp // 6694

Opciones metal / Metal options



NI



PV

Pared/Wall Lamp // 6680

Acabado Cristal / Glass colour



OP-MT

Suspensión/Ceiling Lamp // 6649



CIRCA

design 1976

technical data

263

En Circa todo el globo de vidrio se convierte en emisor de luz ambiente. Su perfil y su volumen, nos recuerda que estamos ante un plafón ya sea colocado en techo o en pared de presencia, discreta y refinada. Circa está fabricada en cristal Triplex opalizado o brillante y el efecto de luz tamizada es muy sugerente. Sus tres tamaños permiten gran variedad de aplicaciones y combinaciones, diseñada para ambientes decorativos, instalaciones y hogares, se trata de un producto muy versátil.

In the Circa collection, the glass sphere provides the mood lighting. Its silhouette and volume lend this flushmount lamp an air of refinement, whether it is installed on the ceiling or the wall. Made of triplex opal or shiny glass, Circa lamps give off a subtle, suggestive light. Available in three sizes, the Circa collection allows for a great variety of applications and combinations, either in private homes or larger settings, and is perhaps our most versatile collection.



Plafón/Plafond Lamp // 3460 -20/25/30

Opciones Cristal / Glass options



MT

BR

184

ULM

design 1997

technical data

263

Formas básicas para una lámpara de suspensión que se caracteriza por proyectar luz directa hacia abajo, ideal para iluminar de forma sencilla cualquier estancia con un estilo discreto y funcional. Ulm está disponible en dos formatos, ovalado y cónico, y en el segundo además se puede elegir la versión del clásico cable extensible que le confiere mayor practicidad. Fabricada en vidrio decorado opal blanco en su versión cónica y opal triplex en la ovalada.

The Ulm series of lamps is defined by its basic shapes and its discreet, functional style. It projects direct light downward and is ideal for lighting any room. Ulm is available in two shapes, oval or cone-shaped. The cone-shaped version is also available as a pendant lamp, making it even more practical. This version is made with cut white opal glass while the oval version is made of triplex opal glass.

^ Suspensión/Ceiling Lamp // 6656

Acabado Cristal / Glass colour



OP-MT

^ Suspensión/Ceiling Lamp // 6654

Acabado Cristal / Glass colour



OP-MT

^ Suspensión/Ceiling Lamp // 6899 (1/3 luces/lights)

Acabado Cristal / Glass colour



OP-MT





NICO

design 1997

technical data

265

Nico se compone de dos formatos de cristal decorado en blanco o tintados en colores para crear el característico "efecto seda" de los vidrios. Nico son colgantes modernos y elementales que se adaptan a todos los estilos, resolviendo con discreción la iluminación y decoración de espacios. Los difusores están disponibles en cuatro acabados en su versión acampanada y tres en el formato bala, lo que permite ir mas allá pudiéndose instalar a distintas alturas y crear composiciones irregulares, divertidas y originales.

The Nico collection is available in two types of glass, either decorated in white or in various colors to create the characteristic "float glass" effect. These simple pendants with their modern lines go with any type of decor, providing a discreet way to meet all types of lighting needs. Available in four colors for the bell-shaped option and three colors for the bullet-shaped one, these lamps lend themselves to the creation of distinct compositions when hung at different heights.

Suspensión/Ceiling Lamp // 6319



Opciones cristal / Glass options



AZ NA OP-MT

Suspensión/Ceiling Lamp // 6775



Opciones cristal / Glass options



AMB AZ OP-MT VE

186 LOUVRE

design 1999

technical data

265

De aspecto sobrio y funcional, Louvre remite a los clásicos apliques de cuadro, actualizado sin perder su esencia tradicional, ofrece una luz directa sobre el objeto que queremos resaltar. Está realizado en latón o hierro según su acabado. La pantalla difusora de luz permite un leve posicionamiento gracias a la rótula incorporada en su brazo. Disponible en cuatro tamaños y acabados, níquel satinado, anticuario, cobre y latón satinado, que lo hacen perfectamente adaptable a cualquier necesidad.

Simple and functional, the Louvre series is reminiscent of the classic square sconces of yesteryear, updated without losing its traditional feel. It projects a focused, direct light for spotlighting a particular object. Made of brass or iron, depending on the final metal finish, and with an articulated frame, for a fully adjustable shade. Louvre lamps are available in four sizes and finishes - satin nickel, antiqued metal, copper, and satin gold - and thus harmonize with any setting.

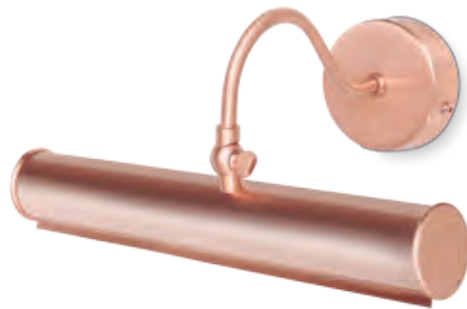

Pared/Wall Lamp // 1575 -25/30/40/45

Opciones metal / Metal options



ANT

CO

LA

NI





Pared/Wall Lamp // 1652

188 DLED

design 2009 / 2016

technical data

264

Dled son una extensa familia de apliques que van desde el aspecto más ligero y minimalista al más contundente debido a la diversidad de tamaños y formatos en el que se presenta, lo que le confiere altas prestaciones tanto decorativas como lumínicas. Fabricados en hierro bañado en níquel satinado combinado con cromo, incluye también una versión acabado pintura mate en blanco o negro, así como una versión que incorpora la madera de haya. Las bases de este aplique van desde el formato cuadrado o redondo según sean las necesidades del usuario y las prestaciones elegidas, sólo pantalla, sólo led o bien una combinación de ambos. Todos disponen de interruptores de encendido en la parte inferior de la base excepto los de “sólo pantalla”. Las pantallas están realizadas en algodón y en distintos formatos según el modelo. El flexo del aplique Dled es un tubo flexible realizado en hierro bañado en cromo para garantizar su rigidez y una mayor calidad en su uso diario, el flexo es adaptable a cualquier posición (flexión máxima 90°) y permite focalizar el punto de luz hacia el lugar deseado sin que se produzcan deslumbramientos, la luz que emite es cálida. El cabezal del led tiene una forma cilíndrica que acentúa su carácter discreto y funcional. Al tratarse de un led de 1.5 W (luz recomendada para lectura), su cabezal apenas desprende calor. Dled se convierte así en el aliado perfecto en los más variados estilos de cabecero de cama, pasillos y aquellos rincones que requieran una luz ya sea focal o ambiental, tanto en el ámbito residencial como en el contract.

Dled is an extensive collection of wall sconces available in different sizes and shapes. Because of this variety, their look can range from airy and minimalist to sturdy and rustic, making them high performance elements for both decoration and illumination. The standard versions are made of iron with satin nickel plating combined with chrome, but they are also available in a black or white painted finishes as well as a beechwood finish. Base shapes can be square or round, depending on the particular model and the client's needs. Lamps can come with only a shade, only a LED bulb, or mixed. All options have the on/off switch on the base except the “only shade” models. All shades are made of cotton in different shapes, depending on the model. The flex model of this family of sconces has a flexible arm made of chrome-plated iron to guarantee its stability and long life with daily use. The flex is fully adjustable with a maximum flexion of 90° to focus a warm light in any direction without glare. These lamps use a 1.5W LED, which means that the cylindrical head of the lamp does not heat up, an important safety factor. Dled is a perfect fixture to use as a bedside lamp, a hall light, and in any nook that needs some type of illumination - either spotlighting or mood lighting - in both public and private settings.



^ Pared/Wall Lamp // 1696

Acabado metal / Metal colour

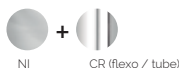

^ Pared/Wall Lamp // 1695

Acabado madera / Wood colour



^ Pared/Wall Lamp // 1694

Pared/Wall Lamp // 1653 >





Pared/Wall Lamp // 1698  BL



Pared/Wall Lamp // 1697  BL

190

technical data

264



Pared/Wall Lamp // 1702  BL



Pared/Wall Lamp // 1701  BL



Pared/Wall Lamp // 1705  BL



Pared/Wall Lamp // 1700  RE

Pared/Wall Lamp // 1699 >  RE

Acabado metal / Metal colour



NI

Acabado madera / Wood colour



HA



192

technical data

264



< Pared/Wall Lamp // 1706 >

Opciones metal / Metal options



Opciones pantalla/ Shade options



Pared/Wall Lamp // 1703

Opciones metal / Metal options

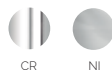

Opciones pantalla/ Shade options



Pared/Wall Lamp // 1704

Opciones metal / Metal options

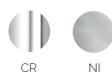

Opciones pantalla/ Shade options





200

ALUMINUM

import 1999

technical data

265

Aluminum refuerza el look natural y son perfectas para iluminar superficies como mesas o barras, todo un clásico sencillo y versátil. Las Aluminum incorporan dos características capaces de llenar nuestras casas de un encanto un tanto retro: por un lado, el acabado en metal y, por otro lado, su aspecto reflector. Uno de los tres modelos está disponible también en color blanco.

Aluminium firm the natural look up and are perfect to light tables or bars, a simple and versatile product. This lamps incorporate two features to fill our houses with a retro glamour: in one side, the metal finishing and in the other side, the reflector appearance. One of them is available also in white color.



light-import
BY MASSMI

ACABADOS BAÑO / METAL PLATE FINISHES

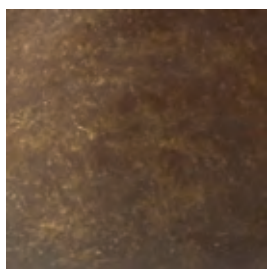

ANT- ANTICUARIO //
ANTIQUARY

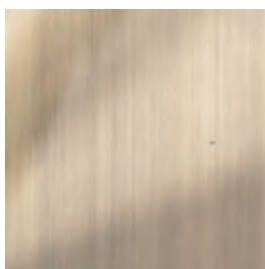

PV- CUERO //
ANTIC BRASS



CO- COBRE BRILLO //
SHINY COPPER



CO- COBRE SATINADO //
SATIN COPPER



LA- LATONADO SATINADO //
SATIN BRASS



LA - LATONADO BRILLO //
SHINY BRASS



NI- NIQUEL SATINADO //
SATIN NICKEL



GM- GRAFITO SATINADO //
SATIN GRAPHITE

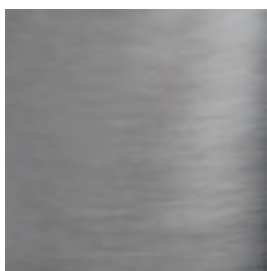

PL- PLATA VIEJA //
ANTIC SILVER



CR- CROMO//
CRHOME



D- DORADO SATINADO//
SATIN GOLD



D- DORADO BRILLO//
SHINY GOLD



DM- DORADO MATE //
GOLD MATTE



CM- NIQUEL MATE//
NICKEL MATTE

* Este acabado es específico
para proyectos // this color is
specific for projects.

ACABADOS PINTURA / PAINTED FINISHES



AM- AMARILLO //
YELLOW



RO- ROJO //
RED



VE- VERDE OSCURO //
DARK GREEN



VE- VERDE //
GREEN



BL- BLANCO BRILLO //
SHINY WHITE



BL-MT- BLANCO TEXTURADO //
TEXTURED MATT WHITE



NE-MT - NEGRO TEXTURADO //
TEXTURED MATT BLACK

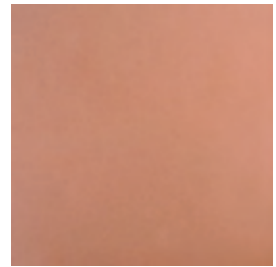

CO- COBRE //
COPPER



GR- GRIS CLARO //
LIGHT GREY

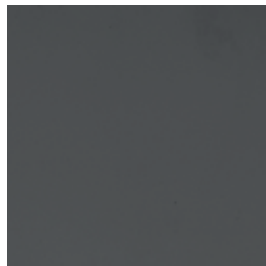

GO- GRIS OSCURO //
DARK GREY



MF- MARFIL //
IVORY

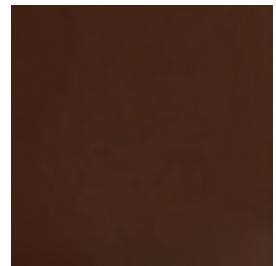

MA- MARRON //
BROWN

ACABADOS MADERA / WOOD FINISHES



HA / NAT - HAYA //
NATURAL BEECH

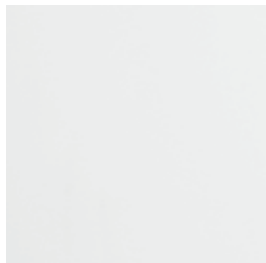

BL- LACADO BLANCO //
WHITE PAINTED

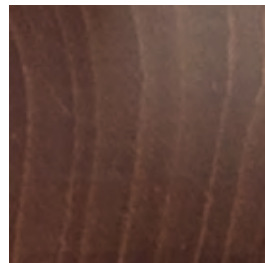

NO- NOGAL //
WALNUT

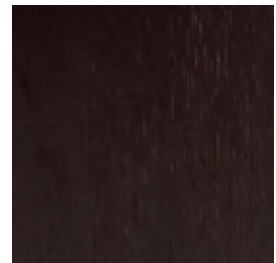

WE- WENGUE //
WENGUE

PANTALLAS / SHADE MATERIALS

236

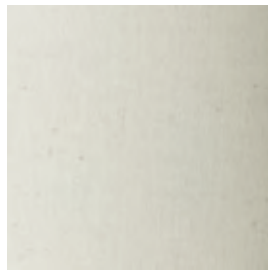

RE- RETORTA //
COTTON RETORTA



NE- NEGRO (int.D) //
BLACK (ins.D)



BL- BLANCO (int.D) //
WHITE (ins.D)

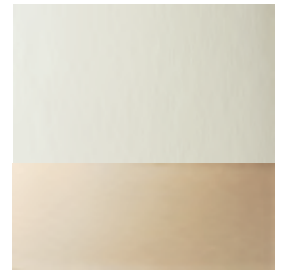

CR- CREMA (int.D) //
BEIGE (ins.D)



LI- LINO CRUDO //
NATURAL LINEN



YU- YUTE CRUDO //
JUTE

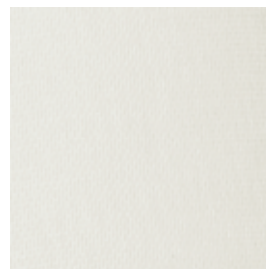

CR- LINON CREMA //
BEIGE LINEN

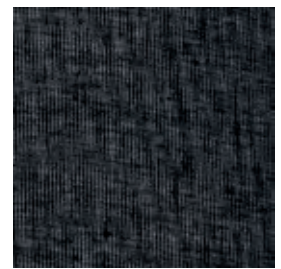

NE- LINON NEGRO //
BLACK LINEN



BL- ALGODÓN BLANCO //
WHITE COTTON

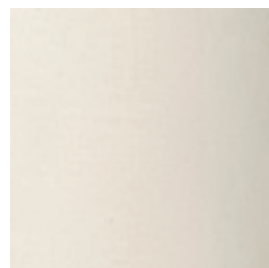

CR- ALGODÓN CREMA //
BEIGE COTTON



BL- ALGODÓN CRUDO //
NATURAL COTTON



GR- ALGODÓN GRIS CLARO //
CLEAR GREY COTTON



GO- ALGODÓN GRIS OSC. //
DARK GREY COTTON

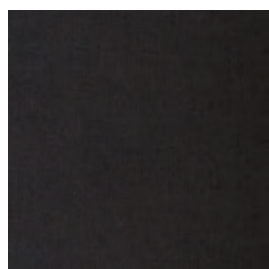

NE-ALGODÓN NEGRO //
BLACK COTTON

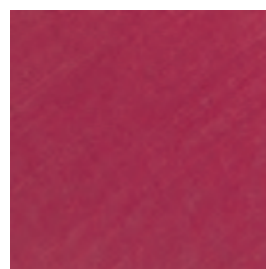

RO- ALGODÓN ROJO //
RED COTTON

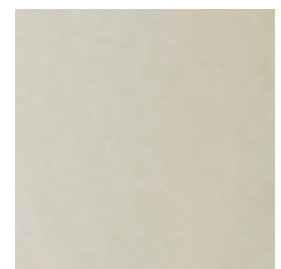

PER- PERGAMINO //
PARCHMENT



CR- ELECTRA CREMA //
BEIGE ELECTRA

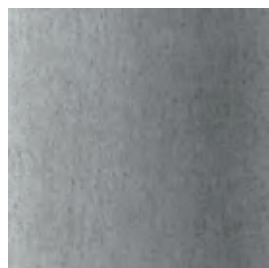

GR- ELECTRA GRIS //
GREY ELECTRA



BL- ACRILICO BLANCO //
WHITE ACRYLIC



NE- ACRILICO NEGRO //
BLACK ACRYLIC



CR- PLISADO CREMA //
BEIGE PLEATED COTTON

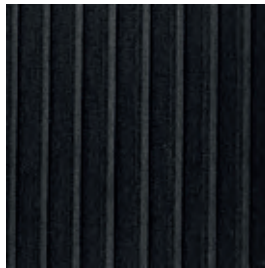

NE- PLISADO NEGRO //
BLACK PLEATED COTTON



LA- LAMITEX // TECHNICAL PVC



MA- MARSALA //



BL- CINTA SEDA BLANCO //
RIBBON OF WHITE SILK



CR- CINTA SEDA CREMA //
RIBBON OF CREAM SILK



NE- CINTA SEDA NEGRO //
RIBBON OF BLACK SILK



RO- CINTA SEDA ROJO //
RIBBON OF RED SILK

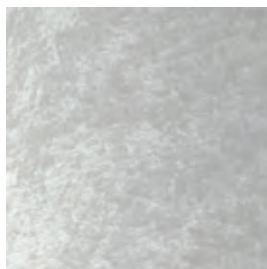

CR- TERCIOPELO CREMA //
BEIGE VELVET

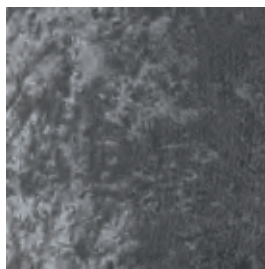

GR- TERCIOPELO GRIS //
GREY VELVET

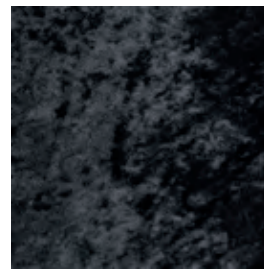

NE- TERCIOPELO NEGRO //
BLACK VELVET



NA- NACAR NARANJA //
ORANGE NACRE



RA- RAFIA //



BL- FRESNO TINTADO BLANCO //
ASH-TREE WHITE COLORED

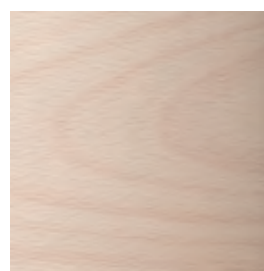

HA- HAYA NATURAL //
NATURAL BEECH

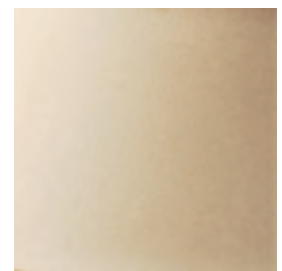

D- DORADO //
GOLD



D- TÉCNICO DORADO //
TECHNICAL GOLD



PL- TÉCNICO PLATA //
TECHNICAL SILVER

ESPECIFICACIONES // REMINDER

Los materiales de pantalla son únicos para cada colección. Lo aquí expuesto es un muestrario.
This sample book is for general reference. Each collection has its own shade and glass materials.

ACABADOS CRISTAL / GLASS FINISHES

238

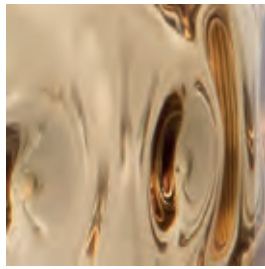

AMB- AMBAR //
AMBER



TR- TRANSPARENTE //
TRANSPARENT



NA- NARANJA //
ORANGE



AZ- AZUL //
DARK BLU

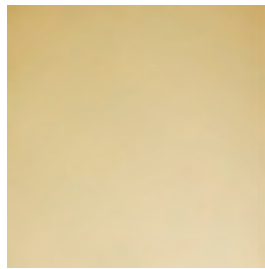

AM- AMARILLO //
YELLOW



VE- VERDE //
GREEN

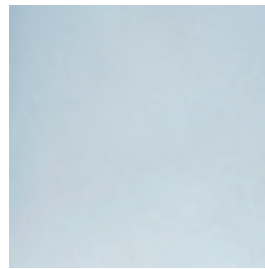

AZ- AZUL CLARO //
LIGHT BLU



OP-MT - OPAL MATE //
OPAL MATTE



VE- TRIPLEX VERDE //
TRIPLEX GREEN



AM- TRIPLEX AMBAR //
TRIPLEX AMBER



OP- OPAL BRILLO //
SHINE OPAL



VE- VERDE //
GREEN



D- PAN DE ORO //
GOLD

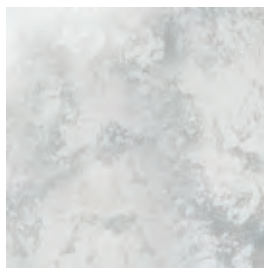

PL- PAN DE PLATA //
SILVER



TER- TERRACOTA //
TERRACOTTA



FU- FUME //
SMOKED

ESPECIFICACIONES // REMINDER

Los acabados y colores de Cristal son únicos para cada colección. Lo aquí expuesto es un muestrario.
This is only a sample book. Each glass collection has its own material.

Datos Técnicos Especificaciones

*Technical Data
Specifications*

LAFFIE p_08-09

Suspensión / Ceiling Lamp

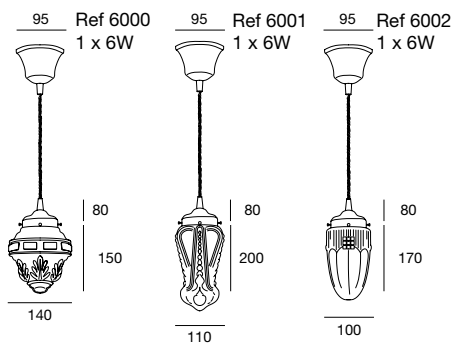

Cristal
Glass



Cuerpo: metal latón con acabado envejecido.
Frame: : antique brass metal.

Detalles: tulipas de cristal al ácido o transparentes.
Cable trenzado marrón.
Details: acid or transparent glass shades. Brown plaited cable.

Bombilla recomendada: E-27. 6W LED (no incluida)
Recommended bulb: E-27. 6W LED (not included)

Importante: ver página 240 / Important: please see page 240

Acabado Metal
Metal Colour



SAVOY p_10-11

Suspensión / Ceiling Lamp

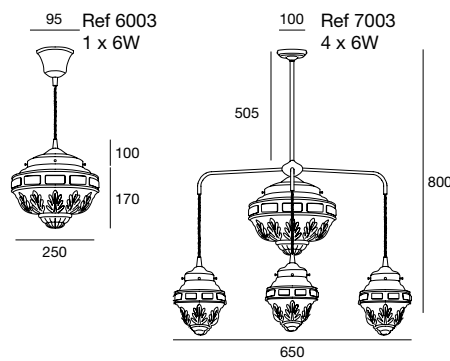

Cristal
Glass



Cuerpo: metal latón con acabado envejecido.
Frame: : antique brass metal.

Detalles: tulipas de cristal al ácido o transparentes,
tubo fijo de 470 mm + cable trenzado marrón.
Details: : acid or transparent glass shades. Metal bar 470mm + Brown plaited cable.

Bombilla recomendada: E-27. 6W LED (no incluida)
Recommended bulb: E-27. 6W LED (not included)

Importante: ver página 240 / Important: please see page 240

Acabado Metal
Metal Colour



CROSBY p_12-13

Suspensión / Ceiling Lamp

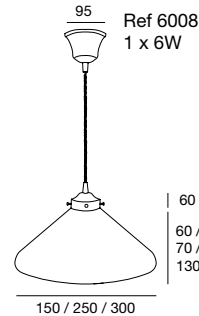

Cristal
Glass



Cuerpo: metal latón con acabado envejecido.
Frame: : antique brass metal.

Detalles : tulipas de cristal triplex en ambar, opal o verde. Cable trenzado marrón. Aplique orientable.
Details: amber, opal or green triplex glass shades. Brown plaited cable. Wall option is adjustable.

Bombilla recomendada: Suspensión E-27. 6W LED
Pared E-14 6W LED (no incluidas)

Recommended Bulb: Ceiling Lamp E-27. 6W LED
Wall Lamp E-14 6W LED (not included)

Importante: ver página 240 / Important: please see page 240

Pared / Wall lamp

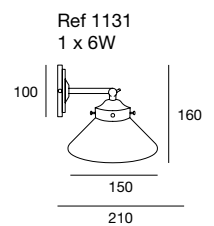

Acabado Metal
Metal Colour



LONDON p_14-15

Mesa / Table Lamp

Ref 4115
1 x 6W

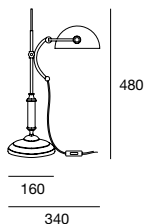

Cristal
Glass



Cuerpo: metal latón con acabado envejecido.
Frame: : antique brass metal.

Detalles: tulipas de cristal triplex en opal o verde. Tulipa orientable en toda la colección. Ref 4115 es orientable en altura y el color de la madera es nogal (ver acabados madera en muestrario).

Details: opal or green triplex glass shades. Adjustable shades for full collection. Ref 4115 is adjustable in height and wood is walnut color (see sample book).

Bombilla recomendada: E-14. 6W LED (no incluida)
Recommended Bulb: E-14. 6W LED (not included)

Ref 4128
1 x 6W

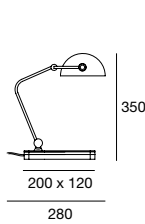

Pared / Wall lamp

Ref 1129
1 x 6W

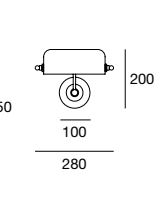

Acabado Metal
Metal Colour



POIRET p_16-17

Mesa / Table Lamp

Ref 4119
1 x 6W

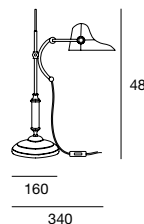

Acabado Metal
Metal Colour



Cuerpo: metal latón con acabado envejecido.
Frame: : antique brass metal.

Detalles: tulipas de tiffanys. Tulipa orientable en toda la colección. Ref 4119 con detalle en madera nogal (ver acabados madera en muestrario).

Details: tiffanys glass shade. Adjustable shades for full collection. Ref.4119 with walnut wood color (see sample book)

Bombilla recomendada: E-14. 6W LED (no incluida)
Recommended Bulb: E-14. 6W LED (not included)

Pared / Wall lamp

Ref 4130
1 x 6W

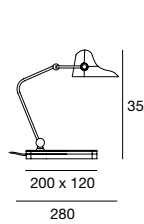

Ref 1133
1 x 6W

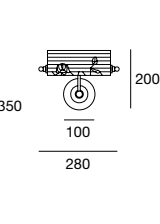

Mesa / Table Lamp

Ref 4129
1 x 6W

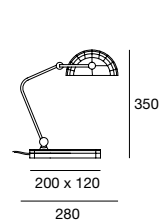

Pared / Wall lamp

Ref 1132
1 x 6W

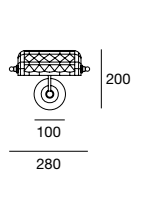

LUIGI p.18-19

Suspensión / Ceiling Lamp

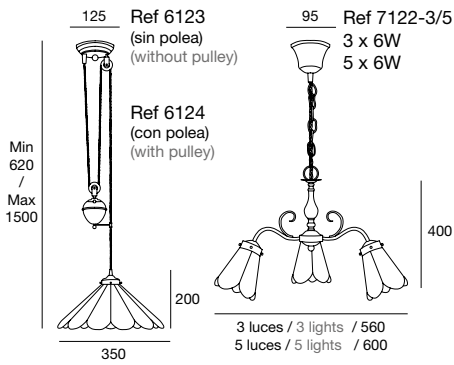

Acabado Metal
Metal Colour



Cuerpo: metal latón con acabado envejecido.
Frame: antique brass metal.

Detalles: tulipas de tiffany. Apliques orientables. En modelos Ref 6123/24 cable trenzado marrón.

Detalles: tiffanys glass shades. Adjustable wall lamps. Ref 6123/ 24 with brown plaited cable.

Mesa / Table Lamp

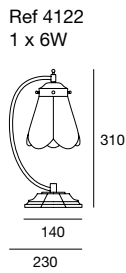

Ref 1122-1
1 x 6W

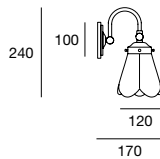

Pared / Wall lamp

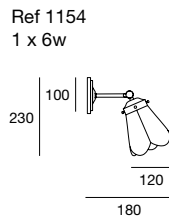

Ref 1122-2
2 x 6W

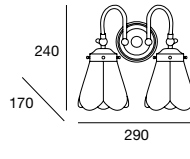

Bombilla recomendada: Suspedidas E-27 6W LED.
Lámparas 3 y 5 luces, apliques 1 y 2 luces y sobremesa E-14 6W LED (no incluidas)

Recommended Bulb: Ceiling lamps E-27 6W LED.
3/5 lights lamps, 1/2 lights wall lamps and table lamp E-14 6W LED. (not included)

Nota importante: ver página 240 / Important: view page 240

CANDEL p.22

Suspensión / Ceiling Lamp

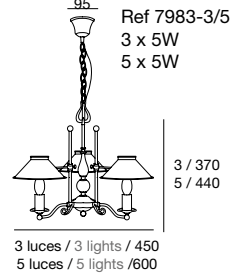

Pared / Wall lamp

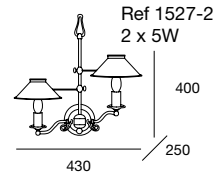

Acabado Metal
Metal Colour



Cuerpo: Metal latón con acabado envejecido.
Frame: antique brass metal.

Detalles: Pantallas regulables en altura.
Details: Adjustable in height shades

Bombilla recomendada: E-14. 5W LED. (no incluidas)
Recommended Bulb: E-14. 5W LED. (no incluidas)

Importante: ver página 240 / Important: please see page 240

Mesa / Table Lamp

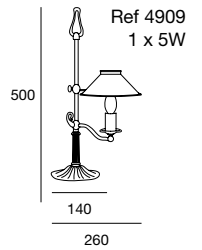

Ref 1527-1
1 x 5W

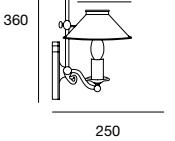

TOURNON p.21

Suspensión / Ceiling Lamp

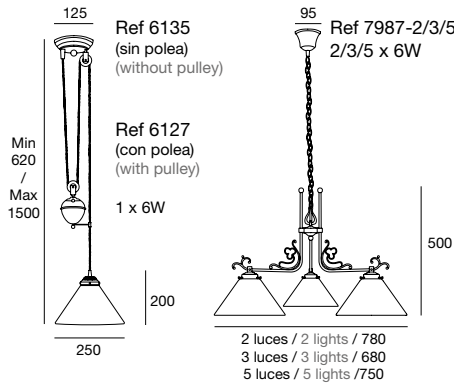

Cristal
Glass



Cuerpo: metal latón con acabado envejecido.
Frame: antique brass metal.

Detalles: tulipas de cristal opal triplex. Aplique orientable. En Ref 6135 / 6127 cable trenzado marrón.

Details: opal triplex glass shade. Adjustable wall lamp. Ref 6135 / 6127 (with pulley) with brown plaited cable.

Mesa / Table Lamp

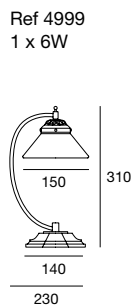

Pared / Wall lamp

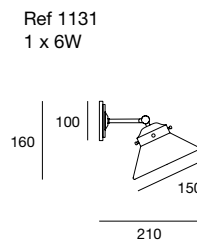

Bombilla recomendada: lampara 2/3/5 luces, aplique y sobremesa E-14. 6W LED. En colgantes con y sin polea E-27. 6W LED (no incluidas).

Recommended bulb: lamps, wall lamp and table lamp E-14. 6W LED. Pendant with and without pulley E-27. 6W LED (not included).

Importante: ver página 240 / Important: please see page 240

Suspensión / Ceiling Lamp

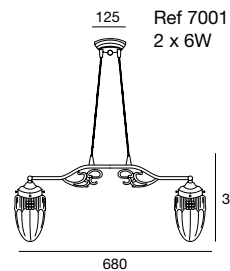

Cristal
Glass



Cuerpo: metal latón con acabado envejecido.
Frame: antique brass metal.

Detalles: tulipas de cristal al ácido. En modelo de suspensión cable trenzado marrón.
Details: acid glass shades. Pendant has brown plaited cable.

Bombilla recomendada: E-27. 6W LED (no incluidas).
Recommended Bulb: E-27. 6W LED (not included).

Importante: ver página 240 / Important: please see page 240

Mesa / Table Lamp

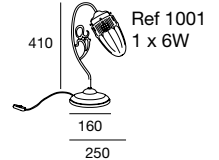

Pared / Wall lamp

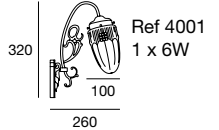

HOLLAND p.23

Suspensión / Ceiling Lamp

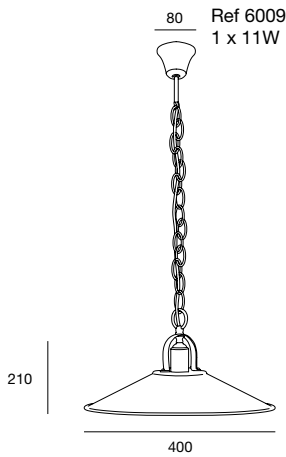

Opciones Metal Metal Colour



D NI PV

Cuerpo: metal hierro bañado en oro brillo, niquel satinado o cuero.

Frame: iron metal with shiny gold, satin nickel or antic brass coating.

Bombilla recomendada: E- 27 11W LED (no incluidas)

Recommended bulb: E- 27 11W LED (not included)

Importante: ver página 240 / Important: please see page 240

CLUB SHADE p.34-35

Suspensión / Ceiling Lamp

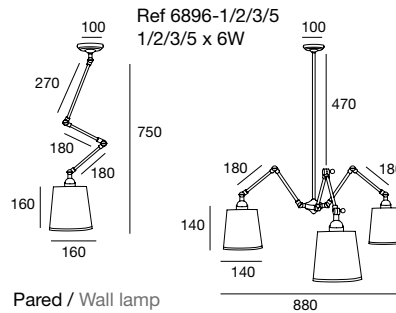

Pared / Wall lamp

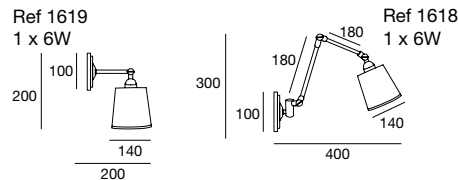

Opciones Metal Metal Colour



ANT PL

Cuerpo: metal latón con acabado envejecido o hierro + latón para el acabado plata vieja.

Frame: antique brass metal or iron + brass metal for antique silver.

Bombilla recomendada: E-27 6W LED (no incluidas)

Recommended Bulb: E-27 6W LED (not included)

Mesa / Table Lamp

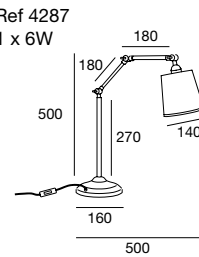

Suelo / Floor Lamp

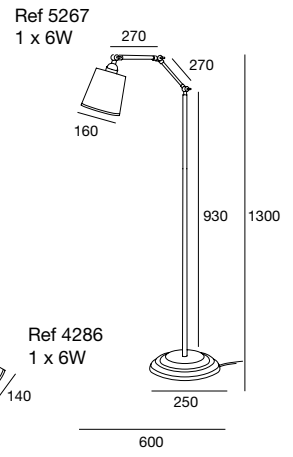

Pantalla Shade



LI

* Ref 6896-3/5 medidas representadas familia club.

* Ref 6896-3/5 shades showed in club collection.

Detalles: Pantalla lino crudo. Lámparas articuladas que varían su posición y medidas según su colocación.

Details: Beige linen. Articulated lamps, position and sizes change.

Importante: ver página 240 / Important: please see page 240

CLUB p.24-33

Suspensión / Ceiling Lamp

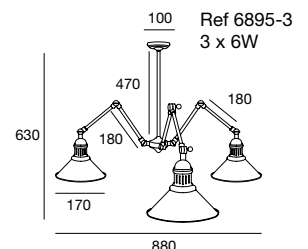
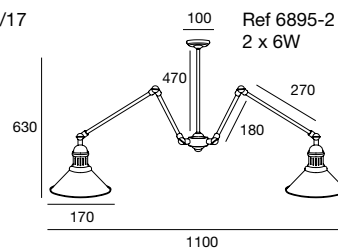
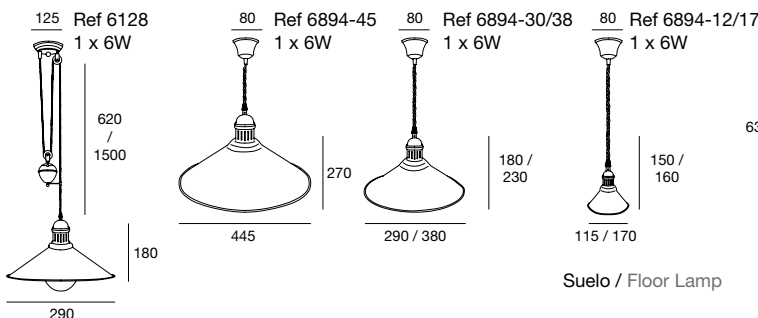

Suelo / Floor Lamp

Mesa / Table Lamp

Pared / Wall lamp

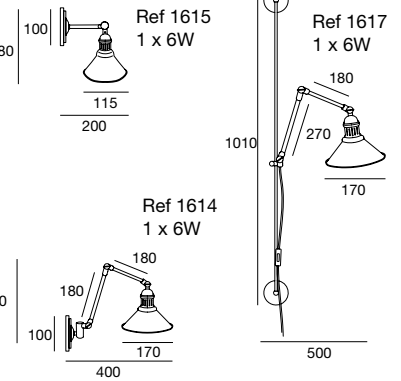
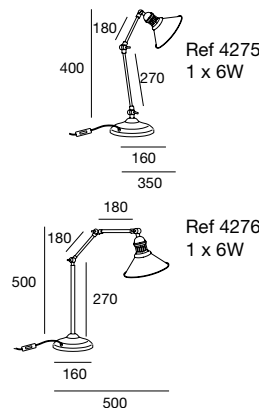
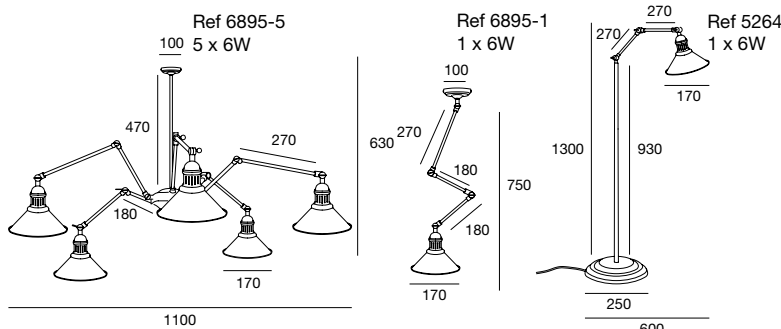

Opciones Metal Metal Colour



ANT PL

Cuerpo: metal latón con acabado envejecido o hierro + latón para el acabado plata vieja.

Frame: antique brass metal or iron + brass metal for antique silver.

Bombilla recomendada: E-27. 6W LED.

Ref 6894-12 y Ref 1615 E-14 6W LED (no incluidas)

Recommended Bulb: E-27. 6W LED

Ref 6894-12 y Ref 1615 E-14 6W LED (not included)

Detalles: lámparas articuladas que varían su posición y medidas según su colocación. Modelo 1617 posee brazo regulable en altura. Modelo 6128 lleva cable trenzado marrón.

Details: articulated lamps, position and sizes change. Ref 1617 has adjustable arm. Modelo 6128 lleva cable trenzado marrón.

Importante: ver página 240 / Important: please see page 240

LA BOHÉME p.36-37

Suspensión / Ceiling Lamp

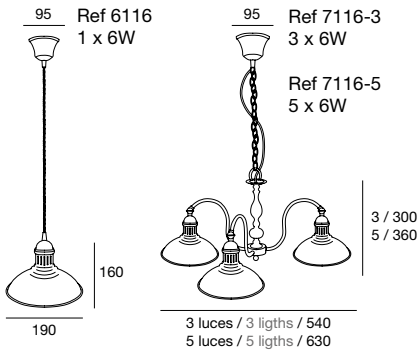

Acabado Metal
Metal Colour



Cuerpo: metal latón con acabado envejecido.
Frame: antique brass metal.

Detalles: lámparas con pantalla orientable. Modelo de mesa regulable en altura. Modelo de suelo es regulable en altura y extiende su brazo a través de una doble rótula. Lámpara de suspensión de una lleva cable trenzado marrón.

Pared / Wall lamp

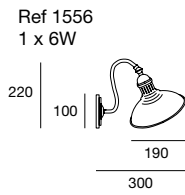

Mesa / Table Lamp

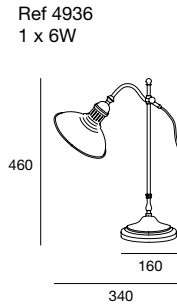

Suelo / Floor lamp

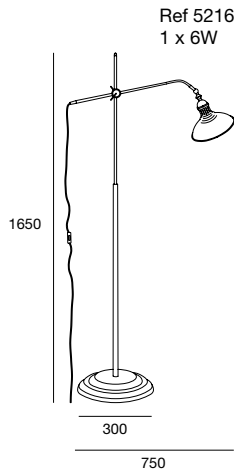

Details: lighting fixtures with adjustable shade. Table lamp adjustable in height. Floor lamp adjustable in height and the arm uses a double kneecap. One light pendant has brown plaited cable.

Bombilla recomendada: E-27. 6W LED (no incluida)
Recommended bulb: E-27. 6W LED (not included)

Importante: ver página 240 / Important: please see page 240

JABEL p.38

Suspensión / Ceiling Lamp

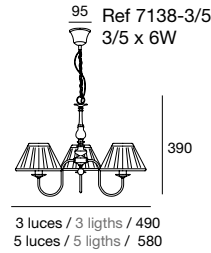

Pared / Wall lamp

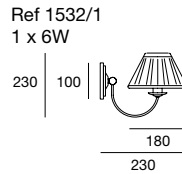

Acabado Metal
Metal Colour



Cuerpo: metal latón con acabado envejecido.
Frame: antique brass metal.

Detalles: pantalla tableada de seda crema.
Details: beige pleated silk shade.

Bombilla recomendada: E-14. 6W LED (no incluidas)
Recommended Bulb: E-14. 6W LED (not included)

Importante: ver página 240 / Important: please see page 240

Mesa / Table Lamp

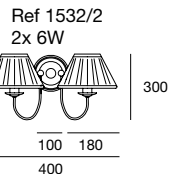
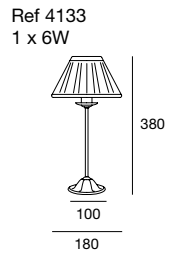

Pantalla
Shade



TALIS p.39

Suelo / Floor Lamp

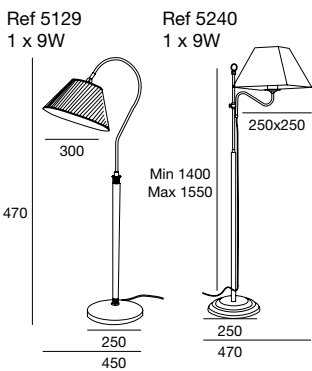

Acabado Metal
Metal Colour



Pared / Wall Lamp

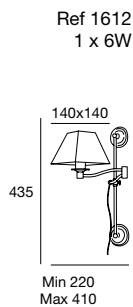

Pantalla
Shade



Cuerpo: metal latón con acabado envejecido.
Ref 5129 madera nogal.

Frame: antique brass metal.
Ref 5129 with walnut wood.

Detalles: pantalla Ref 5129 orientable. Ref 5240 regulable altura de brazo. Ref 1612 articulada y brazo extensible.

Detalles: Ref 5129 adjustable shade. Ref 5240 has adjustable in height arm. Ref 1612 adjustable also in height

Bombilla recomendada: Ref 1612 E-14. 6W LED Ref 5240 / 5129 E-27. 9W LED. (no incluidas)
Recommended bulb: Ref 1612 E-14. 6W LED Ref 5240 / 5129 E-27. 9W LED. (not included)

LARA p.40-41

Plafón / Plafond

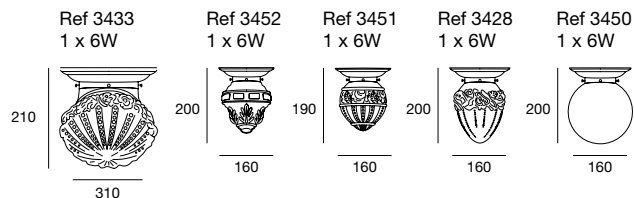

Suspensión / Ceiling Lamp

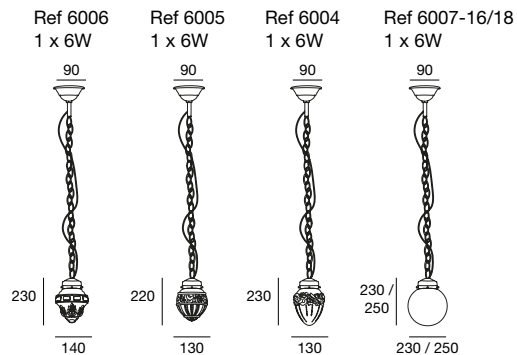

Acabado Metal
Metal Colour



Cuerpo: metal latón con acabado cuero cepillado.
Frame: brass metal with brushed antic finish.

Detalles: cristal centrifugado a molde. Decorado al ácido. Ref 3450 / 6007 opal triplex.

Details: Spin-dried glass. Acid decoration. Ref 3450 / 6007 opal triplex.

Bombilla recomendada: E-27. 6W LED (no incluida)
Recommended bulb: E-27. 6W LED (not included)

Importante: ver página 240 / Important: please see page 240

LOLA p_42-43

Suspensión / Ceiling Lamp

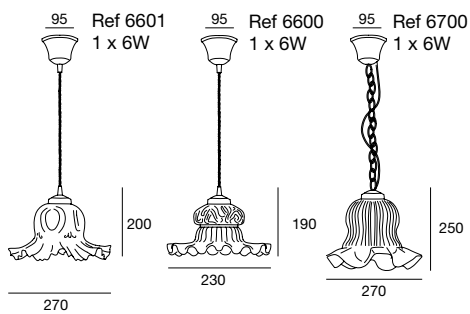

Cristal
Glass

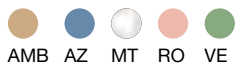

Cuerpo: metal hierro bañado en cuero.
Frame: iron metal with antic brass coating.

Detalles: vidrio soplado con acabado al ácido y decorados en colores. Ref 6600 y 6601 cable trenzado marrón.

Details: acid and colored blown glass. Ref 6600 and 6601 have brown plaited cable.

Bombilla recomendada: E-27. 6W LED (no incluida)
Recommended bulb: E-27. 6W LED (not included)

Nota importante: ver página 240 / Important: view page 240

Acabado Metal
Metal Colour



MOON p_44-45

Suspensión / Ceiling Lamp

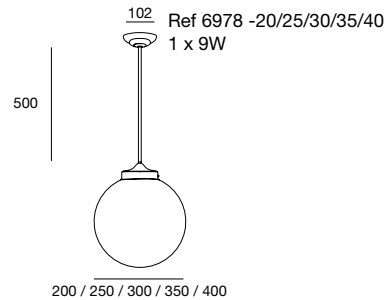

Opciones color
Colour options

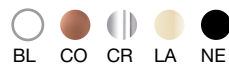

Cuerpo: metal hierro bañado o lacado.
Frame: coated or painted metal.

Detalles: cristal opal triplex.
Details: opal triplex glass.

Bombilla recomendada: E-27. 9W LED (no incluida)
Recommended bulb: E-27. 9W LED (not included)

Importante: ver página 240 / Important: please see page 240

Cristal
Glass



SLIM p_48-49

Suspensión / Ceiling Lamp

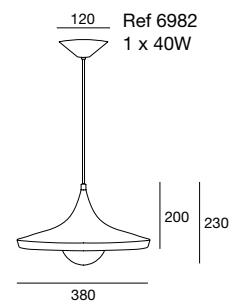

Opciones Metal
Metal Colour



Cuerpo: metal hierro bañado o lacado.
Frame: coated or painted iron metal.

Detalles: cable textil negro o blanco (según opción). Los interiores de pantalla son del mismo color que la parte exterior.

Details: black or white textile cable. Inside has same color than outside shade.

Bombilla recomendada: E-27. 40W · Nostalgic Edison bulb (incluida).
Recommended bulb: E-27. 40W · Nostalgic Edison bulb (included).

Importante: ver página 240 / Important: please see page 240

LITE p_46-47

Suspensión / Ceiling Lamp

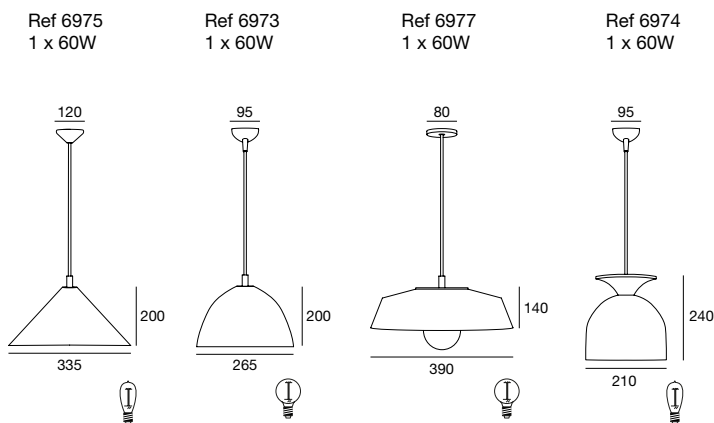

Opciones Metal
Metal Colour



Cuerpo: pantalla hierro bañada o lacada.
Frame: coated or painted iron metal.

Detalles: cable textil negro o blanco (según opción). Los interiores de pantalla son del mismo color que la parte exterior. Sobremesa pantalla orientable e interruptor integrado.

Details: pendant black or white textile wire. Inside has same color than outside shade. Table lamp textile cable. Adjustable shade. Switch included.

Bombilla recomendada (Suspensión): E-27. 40W Nostalgic Edison Bulb (incluida).
Bombilla recomendada (Sobremesa): E-27. 6W LED (no incluida)

Recommended bulb (Ceiling Lamp): E-27. 40W Nostalgic Edison Bulb (included).
Recommended bulb (Table lamp): E-27. 6W LED (not included)

Importante: ver página 240 / Important: please see page 240

Sobremesa / Table lamp

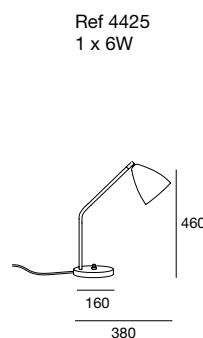

GARLAND p_50-51

Suspensión / Ceiling lamp

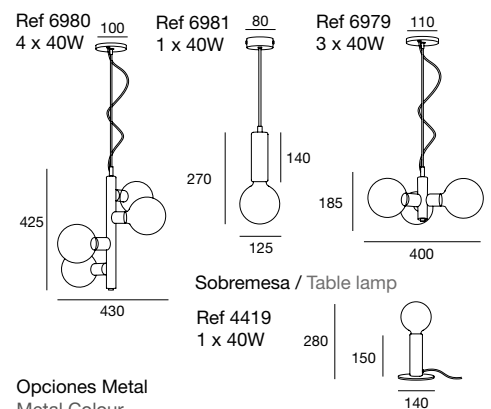

Opciones Metal
Metal Colour



Cuerpo: metal hierro bañado o lacado.
Frame: coated or painted iron.

Detalles: cable textil negro o blanco (según opción) excepto en modelos 6979 / 6980.

Details: : white or black textile cable, excepting Ref 6979-6980.

Bombilla recomendada: E-27. 40W · Nostalgic Edison bulb (incluida)
Recommended bulb: E-27. 40W · Nostalgic Edison bulb (included)

Importante: ver página 240 / Important: please see page 240

BULB p.52-53

Suspensión / Ceiling lamp

Ref 6992
1 x 40W

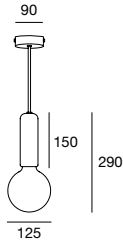

Ref 6991
1 x 40W

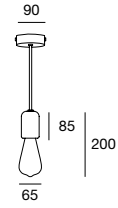

Mesa / Table lamp

Ref 4440
1 x 40W

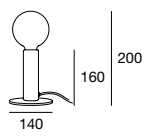

Madera
Wood



HA

Cuerpo: madera de haya barnizada.
Frame: : varnished Beech wood.

Detalles: cable textil negro. Opcional personalizar la lámpara con otros colores disponibles de cable.

Details: black textile cable. If you want to customize your lamp check the colors available for cable in page 232.

Bombilla recomendada: E-27. 40W · Nostalgic Edison Bulb (incluida).

Recommended bulb: E-27. 40W · Nostalgic Edison Bulb (included).

Importante: ver página 240 / Important: please see page 240

NAAF p.56-57

Suspensión / Ceiling lamp

Ref 6857
1 x 9W

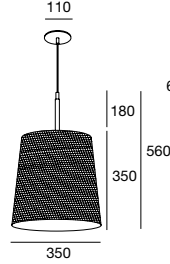

Ref 4457
1 x 9W



Ref 4458
1 x 9W

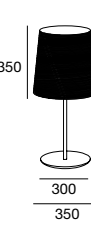

Acabado Metal
Metal Colour



BL-MT

Cuerpo: metal hierro lacado blanco mate texturado.
Frame: white matte painted iron.

Detalles: rafia entretejida. Cable transparente. Bases de 3 mm con tacos.

Details: shade Raffia. Transparent cable. 3mm bases.

Bombilla recomendada: E27 9W LED (no incluida)
Recommended bulb: E27 9W LED (not included)

Importante: ver página 240 / Important: please see page 240

Mesa / Table lamp

INFINITO p.58-59

Suspensión / Ceiling lamp

Ref 6808
3 x 6W

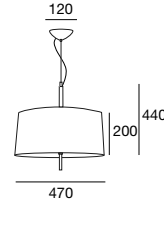

Mesa / Table lamp

Ref 4248
pequeña / small
Ref 4250
grande / big
2 x 6W

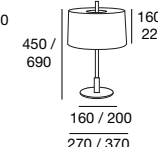

Suelo / Floor Lamp

Ref 5250
3 x 6W

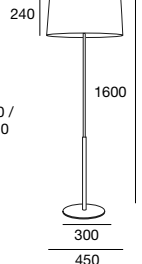

Opciones Metal
Metal Colour



D

NI

Cuerpo: metal hierro bañado.
Frame: coated iron metal.

Detalles: pantalla retorta con difusor superior. La suspensión lleva difusor de cristal. Toda la familia tiene una cogida especial. Cable PVC negro excepto la suspensión (transparente).

Details: : beige canvas cotton shade with top diffuser. This collection has a special support. Black pvc cable except for Pendant (transparent).

Bombilla recomendada: E-27 6W LED (no incluida).
Recommended bulb: E-27 6W LED (not included).

Importante: ver página 240 / Important: please see page 240

Pantalla
Shade



RE

ONLY LED

INFINITO 45° p.60

Suspensión / Ceiling lamp

Ref 6844
3 x 6W

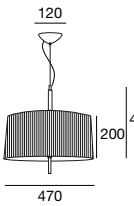

Mesa / Table lamp

Ref 4397
pequeña / small
Ref 4398
grande / big
2 x 6W

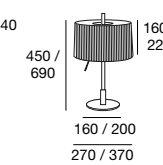

Suelo / Floor Lamp

Ref 5397
3 x 6W

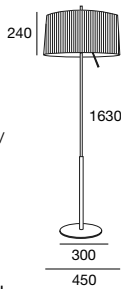

Opciones Metal
Metal Colour



D NI

Cuerpo: metal hierro bañado.
Frame: : coated iron metal.

Detalles: pantalla plisada crema con difusor superior en versiones de mesa y suelo. La suspensión lleva difusor de cristal. Mesa y suelo son basculantes. Toda la familia lleva una cogida especial. Cable PVC transparente.

Details: : beige pleated shade with top diffuser (partial) for table lamp and floor lamp. The pendant has glass diffuser. Table and floor are adjustable by using a kneecap. This collection has a special support. Transparent PVC cable.

Bombilla recomendada: E-27 6W LED (no incluida).
Recommended bulb: E-27 6W LED (not included).

Importante: ver página 240 / Important: please see page 240

ONLY LED

Pantalla
Shade



CR

IN PLEAT p.61

Suspensión / Ceiling Lamp

Ref 6941- 50
2 x 9W

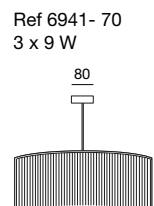

Acabado Metal
Metal Colour



NI

Cuerpo: metal hierro bañado.
Frame: coated iron metal.

Detalles: pantalla plisada crema + retorta. Sistema sujeción pantalla imán. Difusor interior en pergamino blanco. Cable transparente PVC.

Details: beige pleated cotton + beige canvas cotton. Magnet system. interior White parchment diffuser. Transparent PVC cable.

Bombilla recomendada: E-27. 9W LED (no incluida)
Recommended bulb: E-27. 9W LED (not included)

Importante: ver página 240 / Important: please see page 240

Plafón / Plafond

Ref 3493- 50
2 x 9W

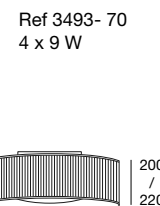

Pantalla
Shade



CR

ONLY LED

IN IRIS p.62-63

Suspensión / Ceiling Lamp

Ref 6923- 50
2 x 9W

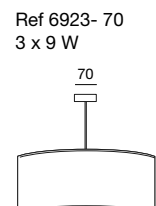

Acabado Metal
Metal Colour



NI

Cuerpo: metal hierro bañado.
Frame: coated iron metal.

Detalles: pantalla tela cotton opaco con interior nácar naranja. Sistema sujeción pantalla imán. Difusor interior pergamino blanco. Cable transparente PVC

Details: white or black opaque cotton and orange inside. Magnet system. White parchment inside diffuser. Transparent PVC cable.

Bombilla recomendada: E-27. 9W LED (no incluida)
Recommended bulb: E-27. 9W LED (not included)

Importante: ver página 240 / Important: please see page 240

Plafón / Plafond

Ref 3476- 50
2 x 9W

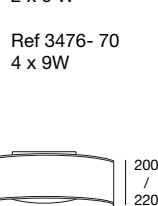

Pantalla
Shade



BL NE

ONLY LED

LOULU

p_64-65

Mesa / Table lamp

Ref 4370 / 4137 / 4420
2 x 9W

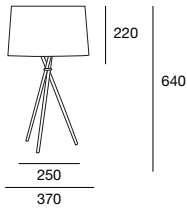

Suelo / Floor lamp

Ref 5370 / 5137 / 5379
3 x 9W

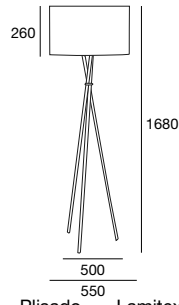

Opciones Metal
Metal Colour



BL MA NE-MT

Acrílico
Acrylic



BL NE

Plisado
Pleated



CR NE

Lamitex
Lamitex



LA

Cuerpo: metal hierro lacado.

Frame: painted iron metal.

Detalles: pantalla acrílica (Ref 4370 / 5370) , plisada (Ref 4137 / 5137) y lamitex (Ref 4420 / 5379). Cable transparente para versión blanco y cable negro para versión negro y marrón.

Details: acrylic Shade (Ref 4370 / 5370), Pleated cotton (Ref 4137 / 5137) or lamitex (Ref 4420 / 5379). Transparent cable for white version and Black cable for brown and black versions.

Bombilla recomendada: E-27. 9W LED (no incluida)

Recommended bulb: E-27. 9W LED (not included)

Importante: ver página 240 / Important: please see page 240

HANG OUT

p_66 - 67

Suspensión / Ceiling lamp

Ref 6845 plisado / pleated C/S
Ref 6846 algodón blanco / cotton C/S
2 x 9W

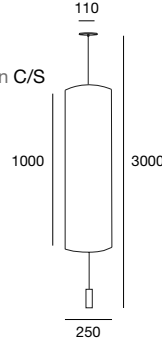

c: con sistema inferior enchufe
c: instalación inferior (enchufe)/with plug connection.
s: con sistema superior techo
s: instalación superior (techo)/with ceiling connection.

Acabado Metal
Metal Colour



NI

Algodón 6846
Cotton 6846



BL

Plisado 6845
Pleated 6845



CR NE

Cuerpo: metal hierro cromado en su estructura interior y níquel satinado en contrapeso y florón.

Frame: chromed iron metal for inside structure and satin nickel for canopy and counterweight.

Detalles: pantalla versión plisados crema y negro. Versión en algodón blanco. La lámpara sube y baja a través de un mecanismo interior por el que desliza el acero.

Details: beige or black pleated cotton shades and white cotton option. Up and down lighting fixture with interior mechanism and sliding steel wire.

Bombilla recomendada: E-27 9W LED (no incluida)

Recommended bulb: E-27 9W LED (not included)

Importante: ver página 240 / Important: please see page 240

FUSTA

p_68-69

Suelo / Floor lamp

ONLY LED

Ref 5390
1 x 9W

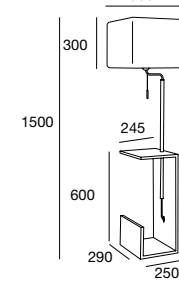

Ref 5391
1 x 9W

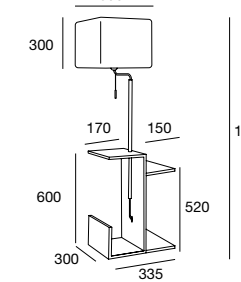

Acabado Metal
Metal Colour



NI

Madera
Wood



BL NAT WE

Pantalla
Shape



BL

Cuerpo: metal hierro acabado en níquel satinado y mesita / revistero de madera.

Frame: satin nickel iron metal + wood table/magazine rack. Wood table/magazine rack can be white, natural and wenge

Detalles: pantalla con difusor superior parcial. Cable transparente PVC. Interruptor de tirador.

Details: white cotton shade with top diffuser (partial). Transparent PVC cable. Chain switch.

Bombilla recomendada: E-27 9W LED (no incluida)

Recommended bulb: E-27 9W LED (not included)

Importante: ver página 240 / Important: please see page 240

ELEGANCE

p_70-71

Suspensión / Ceiling lamp

Ref 7210
2 x 9W

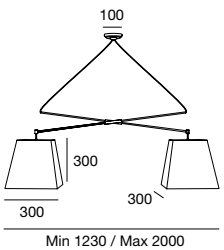

Acabado Metal
Metal Colour



NI CR

Ref 6815- 30 / 40
1 x 11W

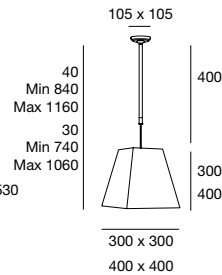

Pantalla
Shade



BL

Cuerpo: metal hierro acabado níquel satinado + cromo en la parte extensible.

Frame: satin nickel iron metal + chrome for extending part.

Detalles: pantalla cotton blanco. Cable PVC negro en las versiones de mesa y suelo. Transparente en la suspensión. Lámparas extensibles salvo sobremesa pequeña.

Details: White cotton shade. Black PVC cable for table and floor lamps. Transparent for the pendant. Extending lighting fixture except small table lamp.

Suelo / Floor lamp

Ref 5255
1 x 11W

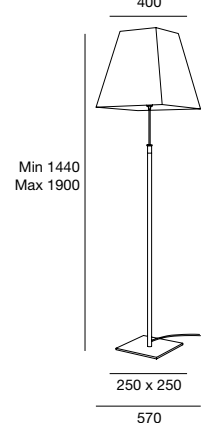

Bombilla recomendada: Ref 7210 / 4296 E-27 9W LED. Ref 6815 / 5255 E-27 11W LED / Ref 4295 E-14 6W LED (no incluidas)

Recommended bulb: Ref 7210 / 4296 E-27 9W LED. Ref 6815 / 5255 E-27 11W LED / Ref 4295 E-14 6W LED (not included)

Importante: ver página 240 / Important: please see page 240

Mesa / Table lamp

Ref 4295
1 x 6W

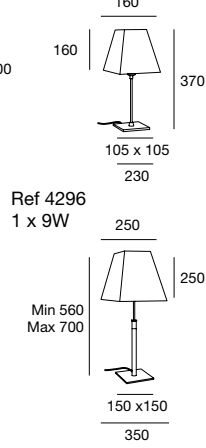

Ref 4296
1 x 9W

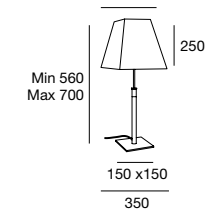

Suspensión / Ceiling lamp

Ref 6930
1 x 11W

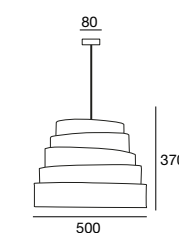

Opciones Metal
Metal Colour



BL NE-MT

Suelo / Floor lamp

Ref 5364
1 x 11W

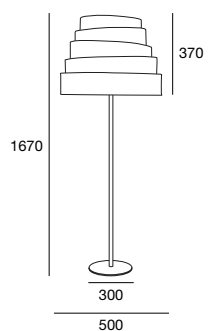

Pantalla
Shade



BL NE

Cuerpo: metal hierro lacado.

Frame: painted iron metal.

Detalles: pantalla tela algodón opaco. Con difusor superior (abierto) en la versión suelo y total en la de suspensión. Cable textil rojo

Details: White or black opaque cotton shade. Top diffuser (open) for floor lamp and complete diffuser for pendant. Red Textile cable

Bombilla recomendada: E-27 11W LED (no incluida)

Recommended bulb: E-27 11W LED (not included).

Importante: ver página 240 / Important: please see page 240

TO BE p.74-75

Suspensión / Ceiling lamp

Ref 6931 Acrílico / Acrylic
1 x 9W

Ref 6932 Electra / Electra
1 x 9W

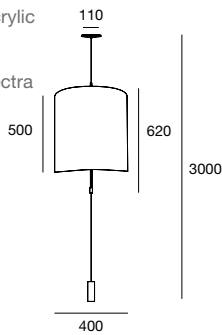

Opciones Metal
Metal Colour



Acrílico
Acrylic



Electra
Electra



Cuerpo: metal hierro lacado o bañado.

Frame: iron metal, colors shiny white, matte black or satin nickel.

Detalles: lámpara sube y baja a través de un mecanismo interior por el que desliza el cable de acero. Con instalación inferior (enchufe). Cogida de la pantalla especial.

Details: up and down lighting fixture with interior mechanism and sliding steel wire. Down connection (plug). Special support.

Bombilla recomendada: E-27 9W LED (no incluida)
Recommended bulb: E-27 9W LED (not included)

Importante: ver página 240 / Important: please see page 240

IN GOLD p.80-81

Suspensión/ Ceiling Lamp

Ref 6942- 50
2 x 9 W

Ref 6942- 70
3 x 9 W

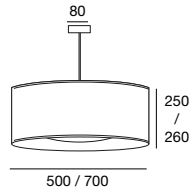

Acabado Metal
Metal Colour



Plafón/ Plafond

Ref 3494- 50
2 x 9 W

Ref 3494- 70
4 x 9 W

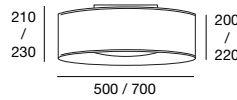

Pantalla
Shade



Cuerpo: metal hierro bañado.

Frame: matte gold iron metal.

Detalles: pantalla tela algodón crema con interior tela técnica dorada -opaca- o viceversa. Sistema sujeción pantalla imán. Difusor interior pergamino blanco. Cable textil negro. Cogida especial.

Details: shade beige opaque cotton and gold technical material inside. Or vice versa Magnet system (plafond). White Parchment diffuser black textile cable. Special support.

Bombilla recomendada: E-27 9W LED (no incluida)
Recommended Bulb: E-27 9W LED (not included)

Importante: ver página 240 / Important: please see page 240

ABBY p.84

Mesa / Table Lamp

Ref 4429
1 x 6W

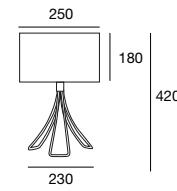

Opciones Metal
Metal Colour



Pantalla
Shade



Cuerpo: metal hierro lacado.

Frame: painted iron metal.

Detalles: pantalla blanco o negro opacos con interior técnico dorado. Cable transparente PVC para la opción en blanco y cable negro PVC para la opción en negro.

Details: white or black opaque cotton shade with gold technical material inside. Transparent PVC cable for white option and black PVC cable for black option.

Bombilla recomendada: mesa E-27 6W LED.
Suelo E-27 11W LED (no incluida)

Recommended bulb: table lamp E-27 6W LED.
Floor lamp E-27 11W LED (not included)

Suelo / Floor Lamp

Ref 5429
1 x 11W

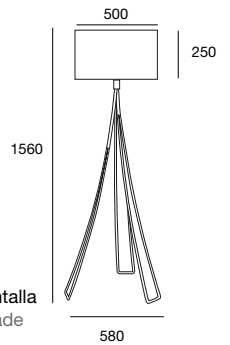

BORROCO p.76-79

Suspensión / Ceiling lamp

Ref 6854
1 x 11W

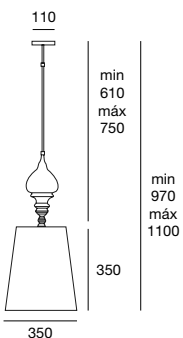

Ref 6852
1 x 11W

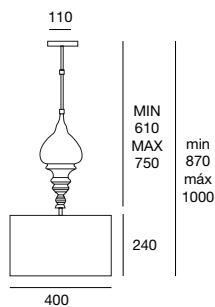

Opciones Metal / cónica
Metal Colour / conical



Opciones Metal / cilíndrica
Metal Colour / cylindrical



Cuerpo: metal hierro acabado oro o níquel satinados en su versión cónica y blanco mate o negro mate texturados en la cilíndrica.

Frame: satin nickel or shiny gold iron metal for the conical version and matte white or matte black for cylindrical version.

Importante: ver página 240 / Important: please see page 240

Mesa / Table lamp

Ref 4455
1 x 9W

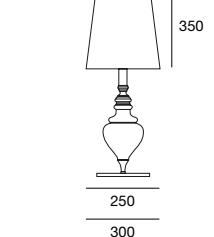

Ref 4453
1 x 9W

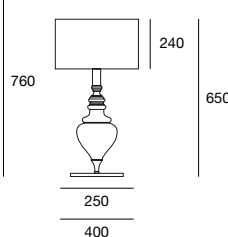

Ref 4454
1 x 9W

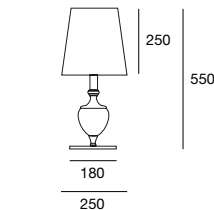

Ref 4452
1 x 9W

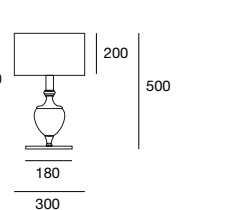

Pantalla
Shade



Detalles: pantalla algodón crudo o negro en ambas versiones. Cable transparente PVC. Extensible estándar 20cm (suspensión)

Details: black or off-white cotton shade. Transparent PVC cable. Standard extending 20cm (ceiling lamp)

Suelo / Floor lamp

Ref 5454
1 x 9W

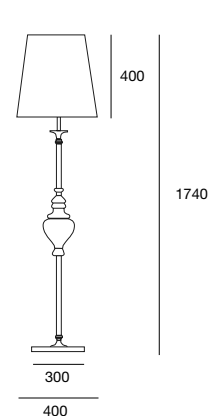

Ref 5452
1 x 9W

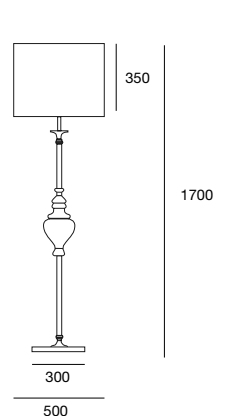

Bombilla recomendada: mesa E-27 9W LED.
Suspensión y suelo E-27 11W LED (no incluidas)

Recommended bulb: table lamp E-27 9W LED.
Ceiling and floor lamp E-27 11W LED (not included)

KAIRÓS

p_82-83

Suspensión / Ceiling lamp

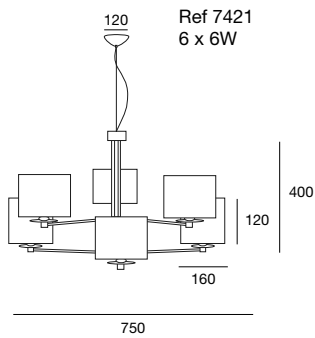

Ref 7421
6 x 6W

Opciones Metal

Metal Colour

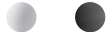

BL-MT NE-MT

Cuerpo: Metal hierro lacado.
Frame: Painted iron metal.

Detalles: Pantalla tela algodón blanco o negro opacos con interior técnico dorado. Cable transparente PVC.

Details: white or black shade opaque cotton and gold technical material inside. Transparent PVC cable.

Suelo / Floor lamp

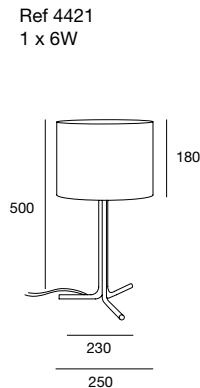

Ref 4421
1 x 6W

Pantalla

Shade



BL NE

Bombilla recomendada: suspensión E-14 6W LED.
Mesa E-27 6W LED. Suelo E-27 11W LED (no incluida)

Recommended bulb: ceiling lamp E-14 6W LED.
Table lamp E-27 6W LED. Floor lamp E-27 11W LED (not included)

Importante: ver página 240 / Important: please see page 240

Mesa / Table lamp

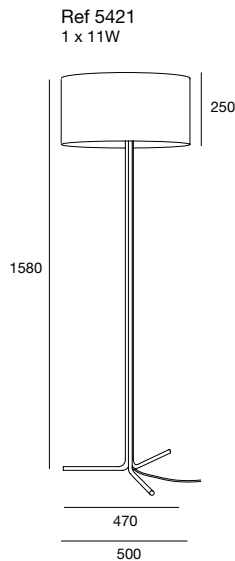

Ref 5421
1 x 11W

VOLUM

p_88-89

Plafón / Plafond

Ref 3485-35 / 40
2 x 9W
Ref 3485-50
4 x 9W

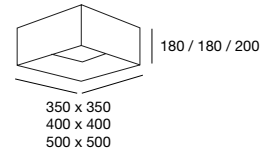

Ref 3483 350x350
2 x 9W

Ref 3484 400x400
3 x 9W

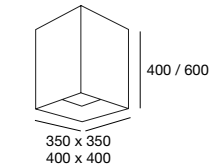

Pantalla

Shade



BL NE

ONLY LED

Detalles: Pantalla tela algodón opaco. Difusor de pergamino blanco. Portalámparas de piedra. Sistema de sujeción de la pantalla con imanes.

Details: White or black opaque cotton shade with white parchment diffuser. Stone socket. Magnet system.

Bombilla recomendada: E-27 9W LED (no incluida)

Recommended bulb: E-27 9W LED (not included)

ORIGAMI

p_85

Suspensión / Ceiling lamp

Ref 6916-40 / 60 / 80
40-1 x 6W
60 / 80-3 x 9W

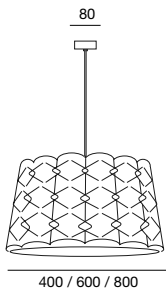

Plafón / Plafond

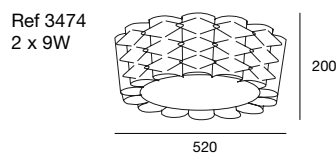

Ref 3474
2 x 9W

Aplique / Wall Lamp

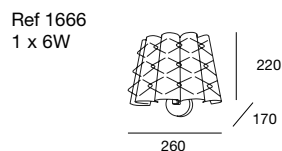

Ref 1666
1 x 6W

Mesa / Table Lamp

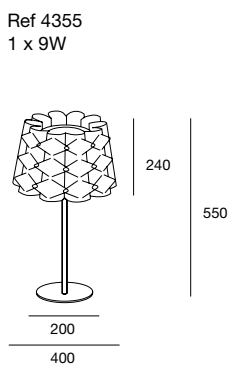

Ref 4355
1 x 9W

Opciones Metal y pantalla

Metal and shade colour



BL BL DM D NI PL

Cuerpo: metal hierro lacado o bañado.
Frame: coated or painted iron metal.

Detalles: Pantalla tela blanco, tela técnica dorada o plata. Difusores pergamino blanco (suspensión y plafón) y difusor superior acabado misma tela técnica (mesa). Cable transparente PVC. Sistema sujeción pantalla con imanes (plafón)

Details: white opaque cotton shade (option BL), gold or silver technical material for options D and PL. White parchment diffuser (pendant and plafond) and top diffuser in same technical material (table). Transparent PVC cable. Magnet system (plafond)

Bombilla recomendada: Suspensión 40 E-27 6W LED / 60 / 80 3 x E-27 9W LED. Plafón E-27 9W LED / Mesa E-27 9W LED. Pared 1 x E-27 6W LED (no incluida)

Recommended bulb: Ceiling lamp 40 E-27 6W LED / 60 / 80 3 x E-27 9W LED / Plafond E-27 9W LED / Mesa E-27 9W LED. Pared 1 x E-27 6W LED (not included)

Importante: ver página 240 / Important: please see page 240

ONLY LED

VOLUM BASIC

p_90

Plafón / Plafond

Ref 3488-35 / 40
2 x 9W

Ref 3488-50
4 x 9W

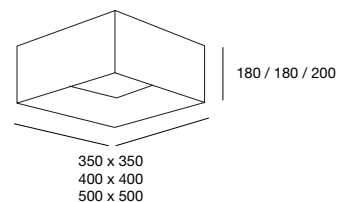

Pantalla

Shade



CR GR

ONLY LED

Detalles: Pantalla de tela algodón Electra. Difusor de pergamino blanco. Portalámparas de piedra. Sistema de sujeción de la pantalla con imanes

Details: Beige or grey Electra cotton shade. White parchment diffuser. Stone socket. Magnet system

Bombilla recomendada: E-27 9W LED (no incluida)

Recommended bulb: E-27 9W LED (not included)

INFINITO NORDIC p.86-87

Suspensión / Ceiling lamp

Ref 6802
3 x 6w

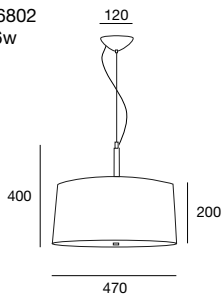

Mesa / Table lamp

Ref 4432G grande / big
2 x 6w

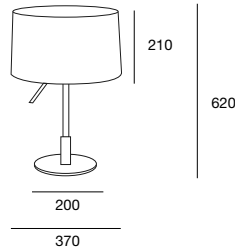

Ref 4432P pequeña / small
2 x 6w

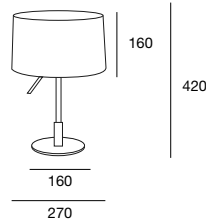

Acabado Metal
Metal Colour



Cuerpo: Metal hierro pintado en blanco mate texturado combinado con madera de haya

Frame: matte white or matte black painted iron, combined with beech wood

Bombilla recomendada: E-27 6W LED (no incluidas)

Recommended bulb: E-27 6W LED (not included)

Importante: ver página 240 / Important: please see page 240

Pantalla
Shade



ONLY LED

Detalles: Pantalla madera natural de haya o fresno tintado en blanco. Cable transparente PVC. Asa y remate de madera en haya. La suspensión lleva difusor de cristal. Los sobremesa son basculantes mediante una rótula. Toda la familia lleva una cogida especial. La mesa grande no lleva difusor. La pequeña lleva un disco parcial para tapar los portalámparas

Details: natural beech wood or white painted ash-tree wood shade. Transparent PVC cable. Beech wood handle and ornament.

The pendant has glass diffuser. Table lamp and floor lamp are adjustable by using a knee cap. This collection has a special support. The big table lamp has not diffuser. The small table lamp use a partial disc to cover the sockets

GATE p.91

Suspensión / Ceiling Lamp

Ref 6947
3 x 9W

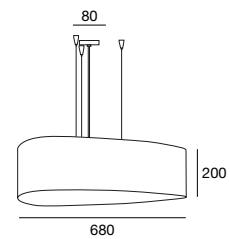

Acabado Metal
Metal Colour



Cuerpo: Metal hierro bañado níquel satinado.

Frame: Satin nickel iron metal.

Detalles: Pantalla tela algodón blanco. Difusor total en pergamino blanco. Forma triangular.

Details: white cotton shade. White parchment complete diffuser.

Bombilla recomendada: E-27 9W LED (no incluida)

Recommended bulb: E-27 9W LED (not included)

Importante: ver página 240 / Important: please see page 240

Pantalla
Shade



ONLY LED

SIXTIE p.92-93

Mesa / Table Lamp

Ref 4459 pequeña / small
1 x 6w

Ref 4460 grande / big
1 x 9w

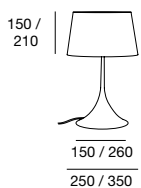

Suelo / Floor Lamp

Ref 5459
1 x 11W

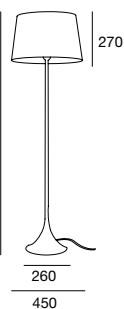

Opciones Metal
Metal Colour



Cuerpo: Metal hierro + latón soldados y pintados en blanco brillo, negro mate texturado u oro brillo.

Frame: iron and brass welded + shiny white, matte black or shiny gold painted.

Detalles: Pantalla tela algodón blanco o negro. Para el cuerpo D hay que especificar el color de la pantalla. Cable transparente PVC para acabados BL y NE. Cable negro PVC para acabado D.

Details: White or black cotton shade. For D option it's necessary to indicate the shade color. Transparent PVC cable for BL and NE options. Black PVC cable for D option.

Bombilla recomendada: 4459 E-27 6W LED / 4460 E-27 9W LED / 5459 E-27 11W LED (no incluidas)

Recommended Bulb: 4459 E-27 6W LED / 4460 E-27 9W LED / 5459 E-27 11W LED (not included)

Pantalla
Shade



INFINITO p.94

Suspensión / Ceiling Lamp

Ref 6928
3 x 6w

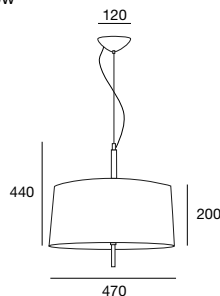

Opciones Metal
Metal Colour



Cuerpo: metal hierro lacado.

Frame: painted iron.

Bombilla recomendada: E-27 6W LED (no incluidas)

Recommended bulb: E-27 6W LED (not included)

Importante: ver página 240 / Important: please see page 240

Pantalla
Shade



ONLY LED

Mesa / Table lamp

Ref 4378 pequeña / small
2 x 6w

Ref 4379 grande / big
2 x 6w

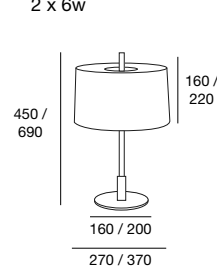

Suelo / Floor lamp

Ref 5368
3 x 6w

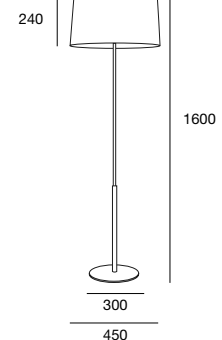

Detalles: Pantalla tela de algodón opaco. Cable transparente PVC (opción BL) y cable negro PVC (opción NE). La suspensión lleva difusor de cristal. Las lámparas de mesa y suelo llevan tapas superiores parciales de la misma tela. Toda la familia tiene una cogida especial. Si lo requieren sin tapa pueden consultar el apartado "pantallas especiales".

Details: Opaque cotton shade. Transparent PVC cable (BL option) and black PVC cable (NE option). The pendant has glass diffuser. Table and floor lamps have top covers partial in same material. Complete collection has special support. If you request without cover you can check section "special shades".

IN p.95

Suspensión / Ceiling Lamp

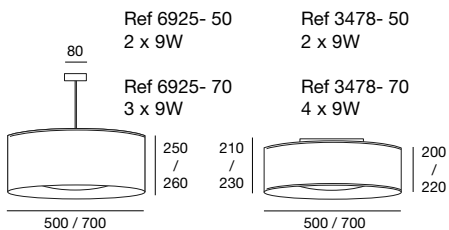

Plafón / Plafond

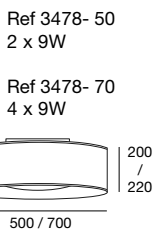

Opciones Metal
Metal Colour



Cuerpo: metal hierro lacado.
Frame: painted iron.

Pantalla
Shade



ONLY LED

Detalles: Pantalla tela algodón opaco. Sistema sujeción pantalla con imanes. Difusor interior en pergamino blanco. Cable textil rojo. Cogida especial

Details: Opaque cotton shade. Magnet system. White parchment inside diffuser. Red textile cable. Special support

Bombilla recomendada: E-27 9W LED (no incluida)
Recommended bulb: E-27 9W LED (not included)

Importante: ver página 240 / Important: please see page 240

INFINITO 45° p.96

Suspensión / Ceiling lamp

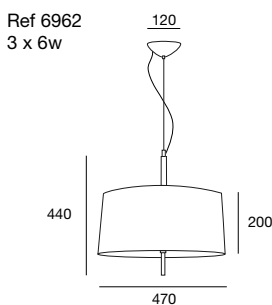

Mesa / Table lamp

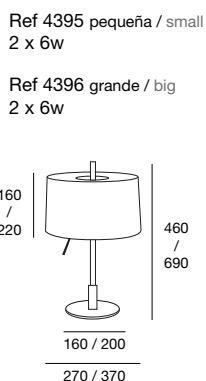

Suelo / Floor lamp

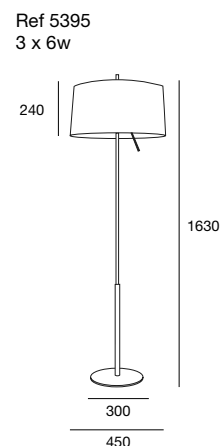

Opciones Metal
Metal Colour



Pantalla
Shade



ONLY LED

Cuerpo: Metal hierro lacado en versiones BL y NE y acabado cromo o níquel satinado en CR y NI.

Frame: painted iron for options BL and NE. Chromed or Satin Nickel for options CR and NI.

Bombilla recomendada: E-27 6W LED (no incluida)
Recommended bulb: E-27 6W LED (not included)

Importante: ver página 240 / Important: please see page 240

Detalles: Pantalla tela algodón opaco ó algodón Electra. Cable transparente PVC en versiones BL, CR y NI. Cable negro PVC en versión NE. La suspensión lleva difusor de cristal. Lámparas de mesa y suelo llevan tapas superiores parciales con su propia tela. Toda la familia tiene cogida especial.

Details: Opaque cotton or Electra cotton shade. Transparent PVC cable (options BL/CR/NI). Black PVC cable (option NE). The pendant has glass diffuser. Table and floor lamps have partial top covers in same material. Special support for complete collection.

IN ELECTRA p.97

Suspensión / Ceiling Lamp

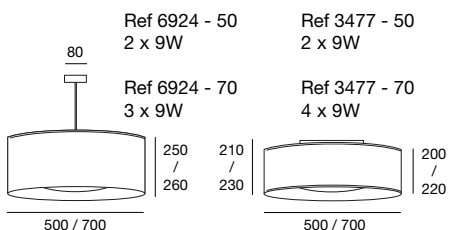

Plafón / Plafond

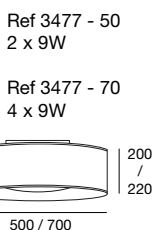

Acabado Metal
Metal Colour



Cuerpo: Metal hierro acabado níquel satinado.
Frame: Satin nickel iron metal.

Pantalla
Shade



ONLY LED

Detalles: Pantalla algodón Electra crema o gris. Sistema sujeción pantalla con imanes. Difusor interior en pergamino blanco. Cable textil rojo. Cogida especial.

Details: Beige or grey Electra cotton shade. Magnet system. White parchment inside diffuser. Red textile cable. Special support.

Bombilla recomendada: E27 9W LED (no incluida)
Recommended bulb: E27 9W LED (not included)

Importante: ver página 240 / Important: please see page 240

LOBBY p.98-99

Mesa / Table lamp

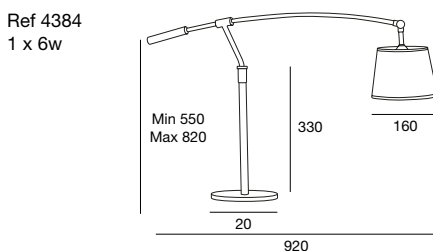

Opciones Metal
Metal Colour



Pantalla
Shade



Cuerpo: Metal hierro lacado o bañado. La parte extensible y regulable en altura es siempre en cromo.

Frame: Painted iron metal and satin nickel. The extending part is always chromed.

Detalles: Pantalla tela algodón opaco. Modelo extensible, regulable en altura y orientable mediante rótula. Cable transparente PVC (opciones NI y BL). Cable negro PVC (opción NE).

Details: Opaque cotton shade. Extending, adjustable in height. Transparent PVC cable (NI and BL options). Black PVC cable (NE option).

Bombilla recomendada: E-14 6W LED (no incluida)
Recommended bulb: E-14 6W LED (not included)

Importante: ver página 240 / Important: please see page 240

MINA p.100

Suelo / Floor Lamp

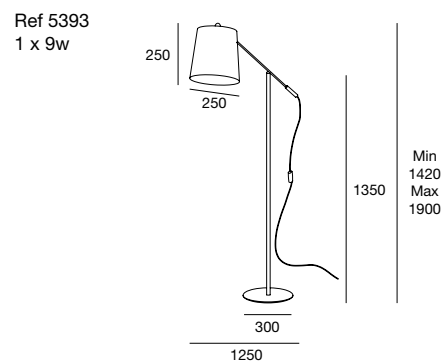

Acabado Metal
Metal Colour



Cuerpo: Metal hierro acabado níquel satinado
Frame: Satin nickel iron metal

Pantalla
Shade



Detalles: Tela de algodón opaco blanco. Lámpara basculante y orientable. Cable PVC transparente
Details: White opaque cotton shade. Adjustable lighting fixture. Transparent PVC wire

Bombilla recomendada: E-27 9W LED (no incluida)
Recommended bulb: E-27 9W LED (not included)

PALM p_101

Suelo / Floor Lamp

Ref 5392
1 x 9w

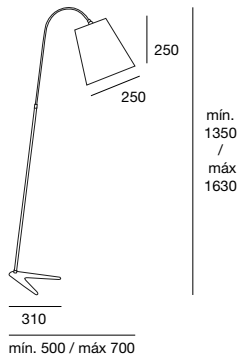

Opciones Metal
Metal Colour



Cuerpo: metal hierro acabado níquel satinado o cromo.

Frame: satin nickel or chromed iron metal.

Detalles: Tela de algodón opaco blanco. Lámpara regulable en altura y orientable. Cable PVC transparente.

Details: White opaque cotton shade. Adjustable lighting fixture. Transparent PVC wire.

Bombilla recomendada: E-27 9W LED (no incluida)
Recommended bulb: E-27 9W LED (not included)

Pantalla
Shade



BL

ATRIUM p_102-103

Suelo / Floor Lamp

Ref 5389
1 x 11w

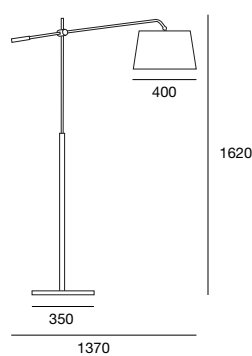

Acabado Metal
Metal Colour



CR

Cuerpo: Metal hierro acabado cromo.

Frame: Chromed iron metal.

Detalles: Tela de algodón opaco blanco. Lámpara regulable en altura, extensible y orientable. Cable transparente PVC.

Details: White opaque cotton shade. Adjustable lighting fixture. Transparent PVC wire.

Bombilla recomendada: E-27 11W LED (no incluida)
Recommended bulb: E-27 11W LED (not included)

Pantalla
Shade



BL

HOLD p_104-105

Suelo / Floor Lamp

Ref 5382
1 x 11W

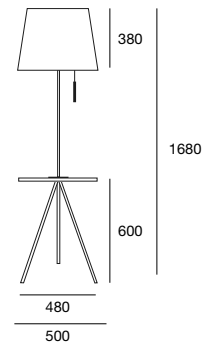

Opciones Metal
Metal Colour



CR

BL

Opciones Mesita
Table Colour



BL

CRISTAL

NAT

WE

BL

Pantalla
Shade

Cuerpo: Metal hierro acabado cromo o lacado.

Frame: Shiny white or chromed iron metal.

Detalles: Tela de algodón opaco blanco. Mesita de madera lacada en blanco, haya, wengué o cristal. Cable transparente PVC. Interruptor de tirador con detalle en cromo.

Details: White opaque cotton shade. White, beech or wenge wood table, or glass table (TR). Transparent PVC wire. Chain switch with chromed handle.

Bombilla recomendada: E-27 11W LED (no incluida)
Recommended bulb: E-27 11W LED (not included)

TRAGALUZ p_106-107

Suspensión / Ceiling Lamp

Ref 7253
2 x 6w

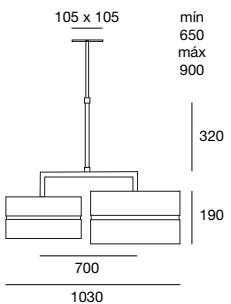

Ref 6906 - 35
1 x 6w

Ref 6906 - 50
2 x 9w

Ref 6906 - 60 / 70
3 x 9w

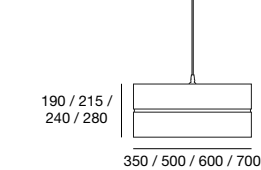

Plafón / Plafond

Ref 3471 - 40 / 50
2 x 9w

Ref 3471 - 60 / 70
4 x 9w

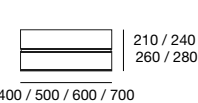

Mesa / Table Lamp

Ref 4354
1 x 6w

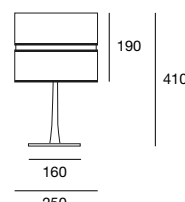

Opciones Metal
Metal Colour



CR

NI

Pantalla
Shade



CR GR NE

ONLY LED

Cuerpo: metal hierro acabado cromo o níquel satinado.

Frame: satin nickel or chromed iron metal.

Detalles: Tela de terciopelo en crudo, gris o negro. Esta serie combina dos pantallas superpuestas por una línea plateada y con aluminio blanco calado. Ref 7253 es extensible. Ref 3471 es plafón imantado y portalámparas de piedra. La serie lleva difusores totales excepto la de mesa que lo lleva parcial. Ref 4354 y 6906 cable transparente PVC.

Detalles: Beige, grey or black velvet shade. This collection combines two shades overlaid with a white aluminum in the middle. Ref 7253 is extending. Ref 3471 has magnet system and stone socket. Complete diffuser for the collection excepting table lamp (partial). Ref 4354 and 6906 have transparent PVC wire.

Bombilla recomendada: E-27 9W LED. Ref 7253, 6906-35 y 4354 6W LED (no incluidas)

Recommended bulb: E-27 9W LED. Ref 7253, 6906-35 and 4354 6W LED (not included)

Importante: ver página 240 / Important: please see page 240

BUBLE p_112-113

Suspensión / Ceiling Lamp

Ref 6138
3 x 6w

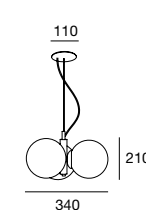

Ref 6139
4 x 6w

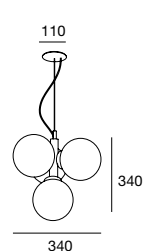

Ref 6140
4 x 6w

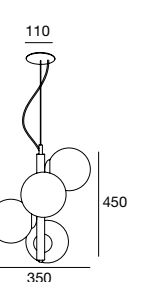

Opciones Metal
Metal Colour



CR

CO

Acabado cristal
Glass Colour



OP-MT

Cuerpo: Metal hierro acabado cromo o cobre brillo

Frame: Chromed or shiny copper iron metal.

Detalles: Tulipas opal mate. Cogida pinzas. Cable acero + transparente PVC.

Details: Matte opal glass, clip system. Steel cable + transparent PVC wire.

Bombilla recomendada: E-14 6W LED. (no incluida)

Recommended bulb: E-14 6W LED. (not included)

Importante: ver página 240 / Important: please see page 240

QUASAR p.108 -111

Suspensión / Ceiling Lamp

Ref 6933 - 50
2 x 9W

Ref 6933 - 70
3 x 9W

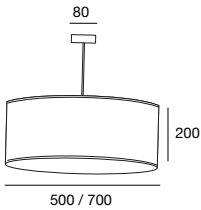

Acabado Metal
Metal Colour



NI

Plafón / Plafond

Ref 3462 - 40 / 45 / 50
2 x 9W

Ref 3462 - 60 / 70
4 x 9W

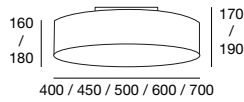

Pantalla
Shade



CR GR NE

Cuerpo: metal hierro acabado níquel satinado + cromo la parte extensible (Ref 1651).

Frame: satin nickel iron metal + chromed for flexible arm (Ref 1651).

Detalles: Tela de terciopelo en crudo, gris o negro. Ref 6933 / 3462 con difusor total de pergamino blanco. Cable transparente de PVC. Ref 3462 con sistema de sujeción de la pantalla con imanes y portalámparas de piedra. Ref 1651 lleva LED 1,4W y transformador incluido. Ref 1645 sujeción de la pantalla mediante ganchos.

Pared / Wall Lamp

Ref 1651
1,4W LED
1 x 6W

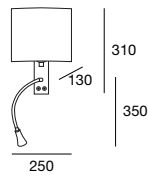

Ref 1646
1 x 6W

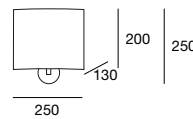

Ref 1645
1 x 6W

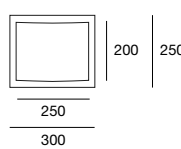

Details: Beige, grey or black velvet shade. Ref.6933/3462 have complete white parchment diffuser. Transparent PVC wire. Ref. 3462 has magnet system and stone socket. Ref.1651 has 1,4W led (included). Ref.1645 uses clip system to hold the shades.

Bombilla recomendada: Ref 6933-50-70 / 3462-40-45-50-60-70 E-27 9W LED. Ref 1651 / 1646 / 1645 6W LED. (no incluidas)

Recommended Bulb: Ref 6933-50-70 / 3462-40-45-50-60-70 E-27 9W LED. Ref 1651 / 1646 / 1645 6W LED. (not included)

Importante: ver página 240 / Important: please see page 240

LLUNA p.114 - 115

Suspensión / Ceiling Lamp

Ref 6880 - 30 / 35 / 40
1 x 9W

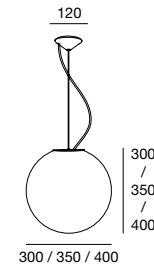

Acabado Metal
Metal Colour



NI

Cuerpo: Metal hierro acabado níquel satinado. Frame: Satin nickel iron metal.

Detalles: Tulipas opal mate. Cogida con tornillos (suspensión). Pinzas (plafón y mesa). Cable acero + transparente PVC.

Details: Matte opal glass. Screws system (ceiling lamp). Clip system (plafond and table lamp). Steel cable + transparent PVC wire.

Bombilla recomendada: E-27 9W LED. (no incluida)

Recommended Bulb: E-27 9W LED. (not included)

Importante: ver página 240 / Important: please see page 240

Plafón / Plafond

Ref 3420
1 x 9W

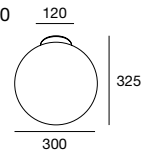

Mesa / Table Lamp

Ref 4239
1 x 9W

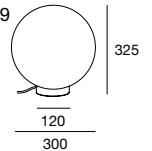

Acabado cristal
Glass Colour



OP-MT

MARSALA p.120 - 121

Suelo / Floor Lamp

Ref 5367
1 x 11W

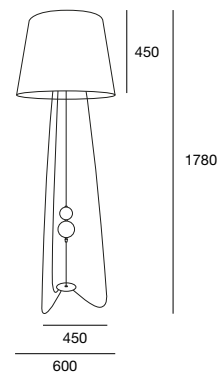

Acabado Metal
Metal Colour



BL-MT

Cuerpo: Metal hierro acabado blanco mate texturado. Frame: Matte white iron metal

Detalles: Pantalla tela de algodón crudo, negro o marsala. Cable negro textil. Las esferas decorativas irán puestas según fotografía.

Details: White off, black or marsala cotton shade Black textile wire. The decorative spheres will be settled as in photo.

Bombilla recomendada: E-27 11W LED. (no incluida)

Recommended Bulb: E-27 11W LED. (not included)

Importante: ver página 240 / Important: please see page 240

TANSHA p.116 - 117

Suspensión / Ceiling Lamp

Ref 6803
1 x 6W

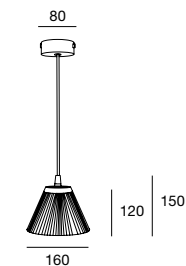

Acabado Metal
Metal Colour



CR

Cuerpo: Metal hierro acabado cromo
Frame: Chromed iron metal

Detalles: Tulipa de cristal al ácido o transparente con calado. Cable textil negro. Base con corte decorativo

Details: Acid or transparent glass shades. Black textile cable. Decorative cut on the base

Bombilla recomendada: Ref 6803 E-27 6W LED. Ref 4403 E-14 6W LED. (no incluidas)

Recommended bulb: Ref 6803 E-27 6W LED. Ref 4403 E-14 6W LED. (not included)

Importante: ver página 240 / Important: please see page 240

Mesa / Table Lamp

Ref 4403
1 x 6W

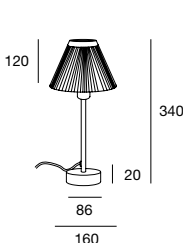

Acabado cristal
Glass Colour



TR MT

ATHINA p.118 - 119

Mesa / Table Lamp

Ref 4456
1 x 6W

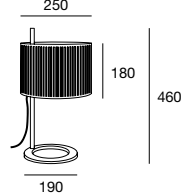

Opciones Metal
Metal Colour



GRA NI

Cuerpo: Metal hierro acabado grafito satinado (versión plisado) ó níquel satinado (versión algodón retorta)
Frame: Satin graphite iron metal (option pleated) or satin nickel iron metal(option canvas cotton)

Detalles: Pantalla tela plisada crudo y algodón retorta. Cable transparente PVC (NI) y cable negro PVC (GRA). Bases vacías en su interior cortadas a láser.

Details: Pleated beige cotton or canvas cotton shade. Transparent PVC wire (option NI) and black PVC wire (option GRA). Empty bases by laser cut.

Bombilla recomendada: Ref 4456 E-27 6W LED. Ref 5456 E-27 9W LED. (no incluidas)

Recommended bulb: Ref 4456 E-27 6W LED. Ref 5456 E-27 9W LED. (not included)

Importante: ver página 240 / Important: please see page 240

Suelo / Floor Lamp

Ref 5456
1 x 9W

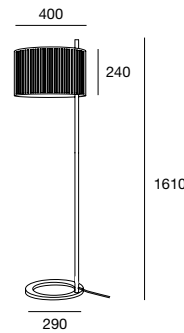

Pantalla
Shade



CR RE

Suspensión / Ceiling Lamp

Ref 6937- 60
3 x 9W

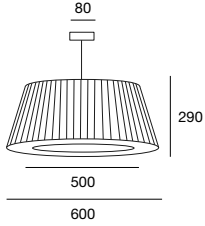

Ref 6937- 80 /100
5 x 9W

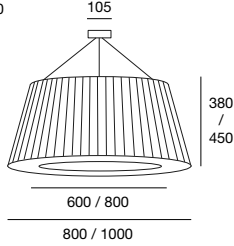

Opciones Metal
Metal Colour



Pantalla
Shade



Cuerpo: metal hierro lacado o bañado.

Frame: shiny white, matte black or satin nickel iron metal.

Detalles: Pantalla seda encintada. Estructura con volumen encintada. Cogidas de la pantalla especiales en suspensión y suelo. Plafón con sistema de sujeción de la pantalla con imanes. Cable transparente de PVC. Montura de suspensión 80 y 100 con cable de acero.

Plafón / Plafond

Ref 3400
2 x 9W

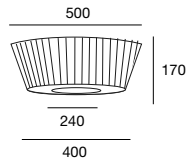

Mesa / Table Lamp

Ref 4400
1 x 6W



Pared / Wall Lamp

Ref 1400
1 x 6W

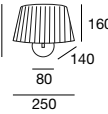

Suelo / Floor Lamp

Ref 5400
3 x 9W

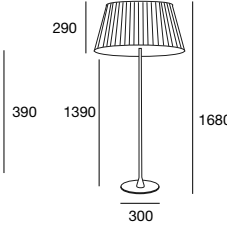

Details: Silk ribbon shade. Structure with silk ribbon volume. Special support for pendant and floor lamp shades. Plafond with magnet system. Transparent PVC wire. For 80d and 100d pendant, steel cable is used.

Bombilla recomendada: Ref 6937-60 / 5400 / 6937-80-100 / Ref 3400 E-27 9W LED. Ref 1400 / 4400 E-27 6W LED. (no incluidas)

Recommended bulb: Ref 6937-60 / 5400 / 6937-80-100 / Ref 3400 E-27 9W LED. Ref 1400 / 4400 E-27 6W LED. (not included)

Importante: ver página 240 / Important: please see page 240

Suelo / Floor Lamp

Ref 5165
1 x 9W

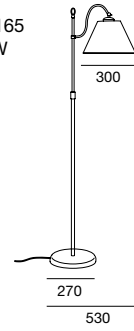

Ref 5166
1 x 9W

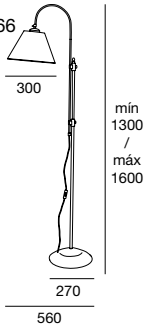

Pantalla
Shade



Acabado Metal
Metal Colour



Pantalla
Shade



Cuerpo: metal hierro + latón acabado en cuero envejecido.

Frame: iron + brass metal, antic brass color.

Detalles: Pantalla Ref 5165 tela algodón crema y Ref 5166 tela algodón retorta. Lámparas regulables en altura y pantalla orientable. Ref 5165 cable negro PVC y Ref 5166 cable dorado PVC

Details: Ref 5165 with beige cotton shade and Ref 5166 with beige cotton canvas shade. Height regulation and adjustable shade. Ref 5165 Black PVC wire and Ref 5166 Gold PVC wire

Bombilla recomendada: E-27 9W LED (no incluida)
Recommended bulb: E-27 9W LED (not included)

Pared / Wall Lamp

Ref 1150
1 x 6W

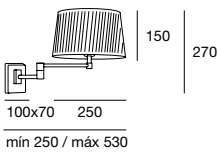

Ref 1149
1 x 6W

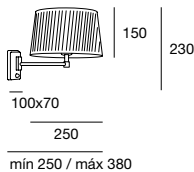

Mesa / Table Lamp

Ref 4157
1 x 6W

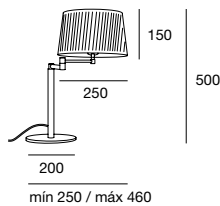

Suelo / Floor Lamp

Ref 5133
1 x 9W

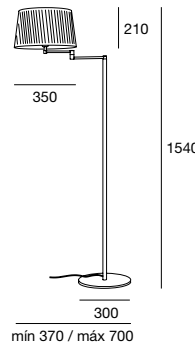

Opciones Metal
Metal Colour

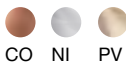

Pantalla
Shade



Cuerpo: metal hierro o latón (según acabado). Acabado en cobre satinado, níquel satinado o cuero envejecido

Frame: iron or brass metal depending on colors. Satin copper, satin nickel or antic brass colors.

Bombilla recomendada: Ref 1149 / 1150 / 4157 E-27 6W LED. Ref 5133 E-27 9W LED (no incluidas)
Recommended bulb: Ref 1149 / 1150 / 4157 E-27 6W LED. Ref 5133 E-27 9W LED (not included)

Detalles: Pantalla tela plisada crudo. Familia articulada. Serie pared con interruptor de pulsador blanco. Cable negro PVC.

Details: Beige pleated cotton shade. Articulated collection. White pushbutton switch for wall lamp. Black PVC wire.

Importante: ver página 240 / Important: please see page 240

Suspensión / Ceiling Lamp

Ref 7873
2 x 9W

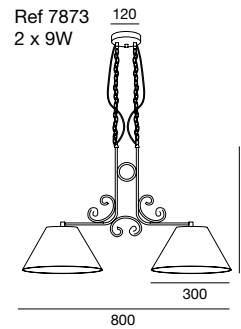

Ref 1140
1 x 6W

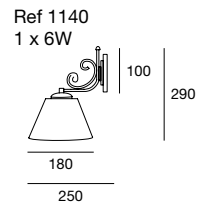

Opciones Metal
Metal Colour



Pantalla
Shade



Cuerpo: metal hierro acabado pintura marrón, marfil o negro mate texturado.

Frame: brown, ivory or matte black iron metal.

Detalles: tela algodón retorta. Cable negro PVC opción marrón y negro y cable transparente para marfil.

Details: Beige cotton canvas shade. Black PVC wire for brown and black options and transparent PVC wire for ivory one.

Bombilla recomendada: Ref 7873 E-27 9W LED. Ref 1140 E-14 6W LED. (no incluidas)
Recommended bulb: Ref 7873 E-27 9W LED. Ref 1140 E-14 6W LED. (not included)

Importante: ver página 240 / Important: please see page 240

AMPORDÁ p_126-127

Suspensión / Ceiling Lamp

Ref 7941- 3
3 x 6w

Ref 7942- 3
3 x 6w

Ref 7941- 5
5 x 6w

Ref 7942- 5
5 x 6w

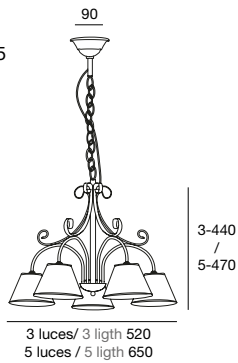
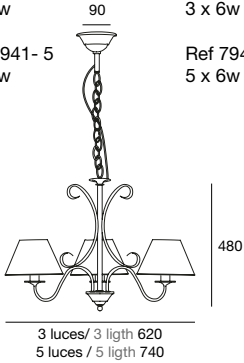

Opciones Metal
Metal Colour

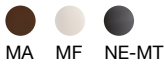

Pantalla
Shade



Cuerpo: Metal hierro acabado pintura marrón, marfil o negro mate texturado

Frame: brown, ivory or matte black iron metal

Detalles: Pantalla tela algodón retorta. Opción MA y NE-MT Cable negro PVC. Opción MF Cable transparente PVC

Details: Beige retorta cotton shade. Black PVC wire for brown and black options and transparent PVC wire for ivory one.

Pared / Wall Lamp

Ref 1507- 1
1 x 6w

Ref 1507- 2
2 x 6w

Ancho / width
1-180 / 2-340

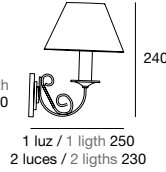

Mesa / Table Lamp

Ref 4154
1 x 6 w

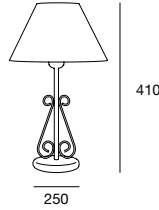

Bombilla recomendada: Ref 7941 / 7942 / 1507 E-14 6W LED. Ref 4154 E-27 6W LED. (no incluidas)

Recommended bulb: Ref 7941 / 7942 / 1507 E-14 6W LED. Ref 4154 E-27 6W LED. (not included)

Importante: ver página 240 / Important: please see page 240

MISTYC p_136

Suspensión / Ceiling Lamp

Ref 6970
3 x 9W

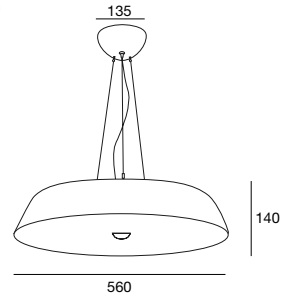

Opciones Metal
Metal Colour



ONLY LED

Cuerpo: metal hierro lacado blanco o negro mate texturados.

Frame: matte white or black metal iron.

Detalles: Cable textil rojo y tensores acero.

Difusor metacrilato

Details: Red textile wire + 3 steel cables. Metacrylate diffuser.

Bombilla recomendada: E-27 9W LED (no incluida)

Recommended bulb: E-27 9W LED (not included)

Importante: ver página 240 / Important: please see page 240

TOULOUSE p_128

Suspensión / Ceiling Lamp

Ref 7870 - 3
3 x 6w

Ref 7872- 3
3 x 6w

Ref 7870 - 5
5 x 6w

Ref 7872- 5
5 x 6w

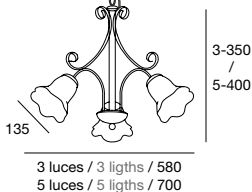
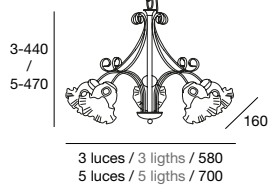

Opciones Metal
Metal Colour

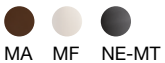

Pantalla
Shade



Cuerpo: Metal hierro acabado pintura marrón, marfil o negro mate texturado

Frame: brown, ivory or matte black iron metal

Detalles: Cristal al ácido. Acabado MA y NE-MT Cable negro PVC. Acabado MF Cable transparente PVC

Details: Acid glass. black PVC wire for brown and black options and transparent PVC wire for ivory one.

Pared / Wall Lamp

Ref 1548 - 1
1 x 6w

Ref 1548 - 2
2 x 6w

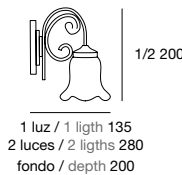

Ref 1410 - 1
1 x 6w

Ref 1410 - 2
2 x 6w

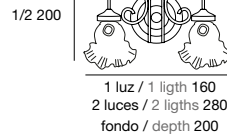

Bombilla recomendada: E-14 6W LED (no incluidas)

Recommended bulb: E-14 6W LED (not included)

Importante: ver página 240 / Important: please see page 240

POPPOL p_137

Suspensión / Ceiling lamp

Ref 6984
1 x 11w

Ref 6985
1 x 11w

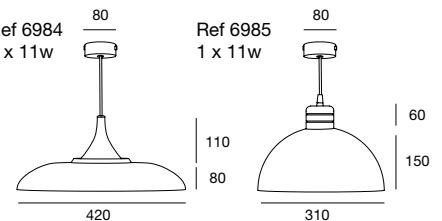

Opciones Metal
Metal Colour



Acabado Madera
Wood Colour



Cuerpo: metal hierro lacado blanco o negro mate texturados.

Frame: matte white or black metal iron.

Detalles: Las pantallas metálicas van dejadas caer sobre unos soportes de madera acabados en haya. Los interiores se acaban como el exterior. Opción BL lleva cable textil blanco y opción NE lleva cable textil negro. Estos modelos tienen la posibilidad de incorporar difusores de plástico flexibles para lugares con humo como cocinas (consultar al servicio de atención al cliente)

Details: Metal shades are dropped under a beech wood holder. Inside has same color than outside shade. There's the option to ask for plastic diffuser for kitchen. Please contact our Customer Support Department.

Bombilla recomendada: E-27 11W LED (no incluida)

Recommended bulb: E-27 11W LED (not included)

Importante: ver página 240 / Important: please see page 240

KARENINA

p_130-131

Suspensión / Ceiling Lamp

Ref 7221
6 x 6W

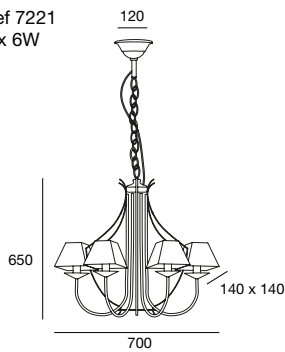

Opciones Metal
Metal Colour

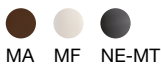

Cuerpo: Metal hierro acabado pintura marrón, marfil o negro mate texturado.

Frame: brown, ivory or matte black iron metal.

Detalles: Pantalla tela yute. Opción MA y NE-MT Cable negro PVC. Opción MF Cable transparente PVC.

Details: Beige Jute shade. Black PVC wire for brown and black options and transparent PVC wire for ivory one.

Pared / Wall Lamp

Ref 1630 -1
1 x 6W

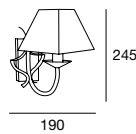

Ref 1630 - 2
2 x 6W

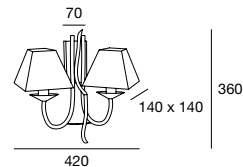

Pantalla
Shade



Mesa / Table Lamp

Ref 4262
1 x 6W

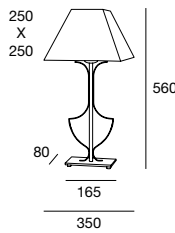

Bombilla recomendada: Ref 7221 / 1630 E-14 6W LED. Ref 4262 E-27 6W LED. (no incluidas)

Recommended bulb: Ref 7221 / 1630 E-14 6W LED. Ref 4262 E-27 6W LED. (not included)

Importante: ver página 240 / Important: please see page 240

BOBBY

p_138

Suspensión / Ceiling lamp

Ref 6972
1 x 9W

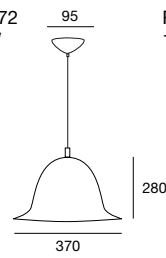

Ref 6952
1 x 9W

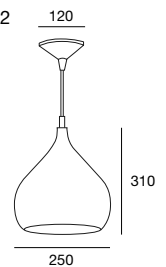

Opciones Metal 6972
6972 Metal Colour



Opciones Metal 6952
6952 Metal Colour



Cuerpo: aluminio lacado.

Frame: painted aluminium.

Detalles: 6972 BL-MT Cable textil azul, CO Cable textil negro y NE-MT Cable textil bicolor blanco y negro. 6952 BL Cable textil rojo, CO Cable textil negro y NE-MT Cable textil negro. Los interiores de pantalla son del mismo color que la parte exterior.

Details: 6972 BL (white) has blue textile wire, CO (copper) has black textile wire, NE (black) has white/black textile wire. 6952 BL (white) has red textile wire, CO (copper) has black wire, NE (black) has black wire. Inside has same color than outside shade.

Bombilla recomendada: E-27 9W Bajo consumo (incluida)

Recommended bulb: E-27 9W Save energy (included)

Importante: ver página 240 / Important: please see page 240

BERKA

p_134 - 135

Suspensión / Ceiling lamp

Ref 6983
1 x 6 W

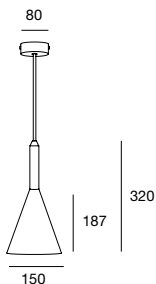

Opciones Metal
Metal Colour



Cuerpo: metal hierro acabado oro brillo, blanco o negro mate texturados.

Frame: shiny gold or matte white/matte black painted iron metal

Bombilla recomendada: Ref 6983 / 4433 E-27 6W LED. Ref 5433 E-27 9W LED (no incluidas)

Recommended bulb: Ref 6983 / 4433 E-27 6W LED. Ref 5433 E-27 9W LED (not included)

Importante: ver página 240 / Important: please see page 240

Mesa / Table lamp

Ref 4433
1 x 6 W

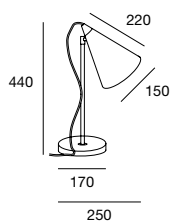

Acabado Madera
Wood Colour



Suelo / Floor lamp

Ref 5433
1 x 9W

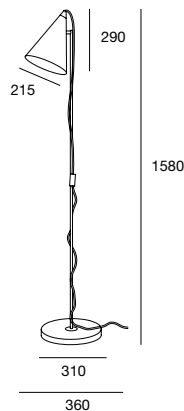

Detalles: Remates y bases en madera de haya. Interiores acabados cada uno con su color exterior. En suspensión opción BL lleva cable textil blanco, opción D lleva cable textil bicolor negro y amarillo y la opción NE cable textil negro.

En mesa y suelo: opción BL lleva cable PVC transparente y opciones D y NE cable PVC negro.

Details: Beech wood for base and decorative pieces. Inside shade has same color than outside. White textile cable for white option, black textile cable for black option and black/yellow textile cable for gold option (Pendant). For table and floor: black PVC wire for options black and gold, and transparent PVC wire for white option.

CLUB ELEMENT

p_139

Pared / Wall Lamp

Ref 1616
1 x 6W

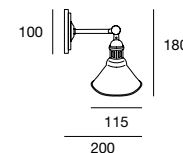

Opciones Metal
Metal Colour



Cuerpo: metal hierro + latón acabado oro, blanco o mate texturados.

Frame: matte white or matte black or gold coat iron and brass metal.

Detalles: Acabado D y NE-MT cable trenzado negro, y acabado BL-MT cable trenzado blanco. Lámpara de pared orientable. Interiores acabados con el mismo color que el exterior.

Details: Black braided wire (D y NE-MT options) and white braided wire (BL-MT option). Wall lamp adjustable. Inside has same color than outside shade.

Bombilla recomendada: Ref 6986-17 E-27 6W LED Ref 6986-30 / 38 E-27 11W LED Ref 1616 E-14 6W LED. (no incluida)

Recommended bulb: Ref 6986-17 E-27 6W LED Ref 6986-30 / 38 E-27 11W LED Ref 1616 E-14 6W LED. (not included)

Importante: ver página 240 / Important: please see page 240

Suspensión / Ceiling Lamp

Ref 6986 - 17
1 x 6W

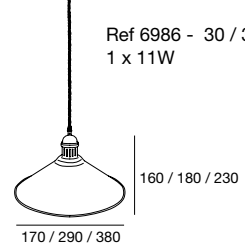

Ref 6986 - 30 / 38
1 x 11W

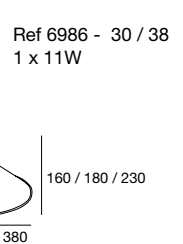

HAT

p_140 - 141

Suspensión / Ceiling Lamp

Ref 6953
1 x 9w

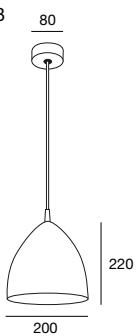

Suelo / Floor Lamp

Ref 5383
1 x 9w

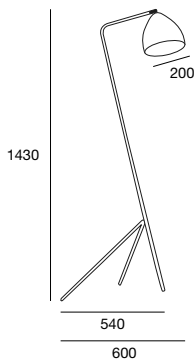

Opciones Metal
Metal Colour



Cuerpo: metal hierro lacado. La pantalla de Ref.5383 es en aluminio.

Frame: painted iron metal. The shade for Ref.5383 is made of aluminium

Bombilla recomendada: E-27 9W Bajo consumo (incluida)

Recommended bulb: E-27 9W Save energy included

Importante: ver página 240 / Important: please see page 240

Detalles: acabado BL cable textil rojo; acabado CO y NE-MT cable textil negro; acabado BL suelo cable transparente PVC y acabado CO y NE-MT suelo cable negro PVC. Los interiores de pantalla son del mismo color que la parte exterior. La lámpara de suelo es orientable tanto horizontal como verticalmente mediante una rótula.

Details: red textile wire (White Pendant), black textile wire (copper and black pendants). Transparent PVC wire (white floor lamp), black PVC wire (copper, black floor lamps). Inside has same color than outside shade.

Floor lamp is adjustable vertical and horizontal by using a kneecap.

SPIDER

p_142 - 143

Suspensión / Ceiling Lamp

Ref 6944
1 x 9W

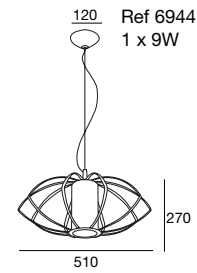

Ref 6945
1 x 40W

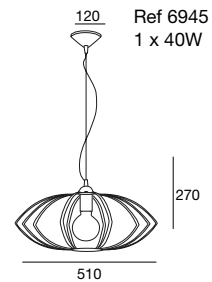

Opciones Metal
Metal Colour



Acabado Cristal
Glass colour



Cuerpo: Metal hierro lacado

Frame: painted iron metal.

Detalles: tapa remate con imanes. Cable de acero + cable transparente PVC (versión BL) y cable negro PVC (versión CO y NE). Tulipa de cristal opal mate Ref.6944.

Details: cover with magnets. PVC wire (transparent for white option and black for copper option) + steel cable. Opal matte glass for Ref 6944.

Bombilla recomendada : Ref 6945 E-27 ø 95 (Ámbar) 40W Decorativa incandescente (incluida) Ref 6944 E-27 9W LED (no incluida).

Recommended bulb : Ref 6945 E-27 ø 95 (Ámbar) 40W Decorative incandescent (included). Ref 6944 E-27 9W LED (not included).

Importante: ver página 240 / Important: please see page 240

BABE

p_144

Mesa / Table Lamp

Ref 4402
1 x 9W

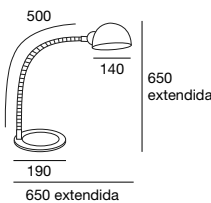

Suelo / Floor Lamp

Ref 5402
1 x 9W

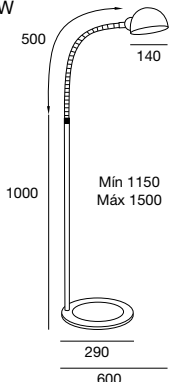

Opciones Metal
Metal Colour



Cuerpo: metal hierro lacado. Parte extensible cromo.

Frame: : painted iron metal. The extending part is chromed.

Detalles: Cable transparente PVC. Los interiores de pantalla son del mismo color que la parte exterior. Orientable y flexible 90°, sin forzarla desde la base

Details: Transparent PVC wire. Inside has same color than outside shade. Adjustable and 90° flexible lighting fixture.

Bombilla recomendada: 1 x E-27 9W Bajo consumo (incluida)

Recommended bulb: 1 x E-27 9W Save energy (included)

MINIMATE

p_145

Mesa / Table Lamp

Ref 4423
1 x 2,5W

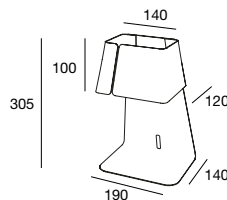

Opciones Metal
Metal Colour



Opciones cable
Wire options



Cuerpo: metal 3 piezas hierro soldadas, lacado en colores.

Frame: three pieces of iron welded and painted.

Detalles: cable textil a elegir u opción de cable transparente PVC.

Details: colored textile or transparent PVC wire.

Bombilla recomendada: G9 2,5W LED. (incluida)

Recommended bulb: G9 2,5W LED. (included)

AURA

p_146 - 147

Suspensión / Ceiling Lamp

Ref 6602- 20 / 25 / 30
1 x 9W

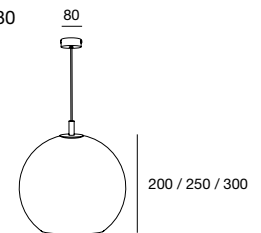

Opciones Metal
Metal Colour



Opciones Cristal
Glass Colour



Cuerpo: metal hierro acabado en cromo u oro brillo.

Frame: chromed or gold iron metal.

Detalles: bola abierta. Decorado pan de oro o pan de plata. Cable textil negro.

Details: open ball. Decoration with gold or silver leaf. Black textile wire.

Bombilla recomendada: E-27 9W LED (no incluida)

Recommended bulb: E-27 9W LED (not included)

Importante: ver página 240 / Important: please see page 240

COCO p_148-149

Suspensión / Ceiling Lamp

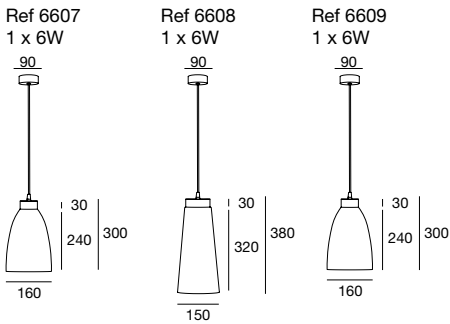

Opciones Cristal
Glass Colour



Acabado Madera
Wood Colour



Opciones Cristal 6608 / 6609
Glass Colour 6608 / 6609



Cuerpo: madera de haya.
Frame: beech wood.

Detalles: Ref 6607 terminada en cristal decorado brillo en varios colores. Ref 6608 / 6609 terminadas en cristal decorado terracota. Cable textil negro
Details: Ref 6607, shiny white, smoked or green decorated glass. Ref 6608 / 6609 Terracotta decoration glass. Black textile wire

Bombilla recomendada: E-27 6W LED (no incluida)
Recommended bulb: E-27 6W LED (not included)

Importante: ver página 240 / Important: please see page 240

GLASSY p_150-151

Suspensión / Ceiling lamp

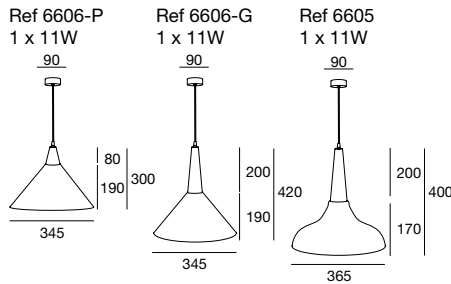

Acabado Cristal 6606 P/G
Glass Colour 6606 P/G



Acabado Madera
Wood Colour



Opciones Cristal 6605
Glass Colour 6605



Cuerpo: madera de haya.
Frame: beech wood.

Detalles: Ref 6606-P/G terminada en cristal opal mate; Ref 6605 terminada en cristal opal brillo o fumé. Cable textil negro. "P" significa madera pequeña y "G" madera grande.

Details: Ref 6606-P/G Matte opal glass; Ref 6605 shiny opal or smoked glass. Black textile wire. "P" means small wood and "G" means big wood.

Bombilla recomendada: E-27 11W LED (no incluida)
Recommended bulb: E-27 11W LED (not included)

Importante: ver página 240 / Important: please see page 240

LOFT p_152

Suspensión / Ceiling Lamp

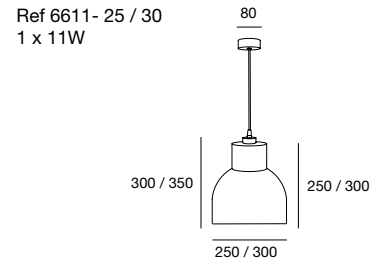

Opciones Cristal
Glass Colour



Acabado Metal
Metal Colour



Cuerpo: metal hierro acabado níquel satinado.
Frame: satin nickel iron metal.

Detalles: cristal decorado opal brillo o fumé. Cable transparente PVC.
Details: shiny opal or smoked glass. Black textile wire.

Bombilla recomendada: E-27 11W LED (no incluida)
Recommended bulb: E-27 11W LED (not included)

Importante: ver página 240 / Important: please see page 240

PIPPA p_153

Suspensión / Ceiling Lamp

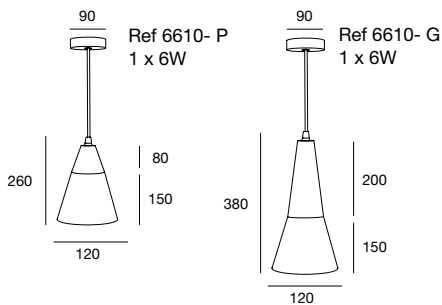

Acabado Cristal
Glass Colour



Acabado Madera
Wood Colour



Opciones cable
Wire options



Cuerpo: madera de haya
Frame: beech wood

Detalles: vidrio centrifugado transparente. Cable textil (ver opciones). "P" significa madera pequeña y "G" significa madera grande.

Details: transparent spin-dried glass. Textile wire (see options). "P" means small wood and "G" means big wood.

Bombilla recomendada: E-27 6W LED. (no incluida)
Recommended bulb: E-27 6W LED. (not included)

Importante: ver página 240 / Important: please see page 240

MARS p_154 - 155

Suspensión / Ceiling Lamp

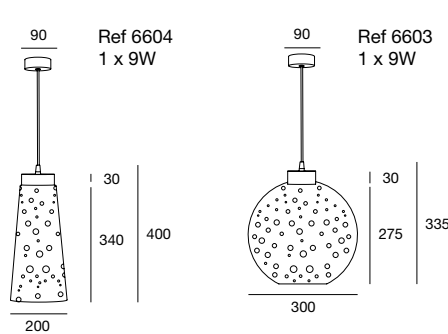

Opciones Cristal
Glass Colour



Acabado Madera
Wood Colour



Cuerpo: madera de haya.
Frame: beech wood.

Detalles: vidrio con burbujas en ámbar o transparente. Cable transparente PVC.

Details: amber or transparent glass with bubbles. Transparent PVC wire.

Bombilla recomendada: E-27 9W LED. (no incluida)
Recommended bulb: E-27 9W LED. (not included)

Importante: ver página 240 / Important: please see page 240

DONA p_164-165

Suspensión / Ceiling Lamp

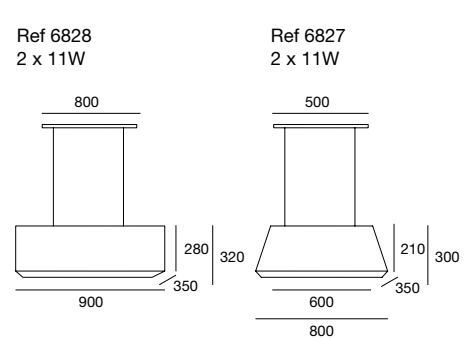

Acabado Metal
Metal Colour



Pantalla Ref 6828
Ref 6828 Shade



Ref 6827
Ref 6827



Cuerpo: metal hierro acabado níquel satinado.
Frame: satin nickel iron metal.

Detalles: pantalla tela algodón retorta (6827) o plisada / retorta (6828). Cable transparente PVC.

Details: beige canvas cotton or beige/black pleated cotton shade (6828). Beige canvas cotton shade (6827). Transparent PVC wire.

Bombilla recomendada: E-27 11W LED. (no incluidas)
Recommended bulb: E-27 11W LED. (not included)

Importante: ver página 240 / Important: please see page 240

Suspensión / Ceiling Lamp

Ref 7921
2 x 9w

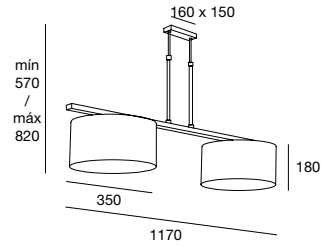

Ref 6920 A/B/C/D
5 x 6w

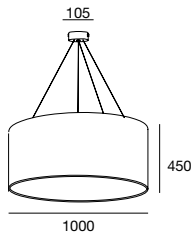

Ref 6921 - 35
1 x 9w

Ref 6921 - 50
2 x 9w

Ref 6921 - 60 / 70
3 x 9w

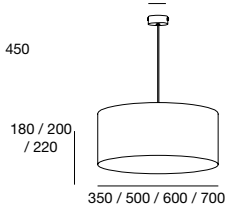

* Toda la serie A/D excepto Ref 6920.
* All collection A/D except Ref 6920.

Acabado Metal
Metal Colour



Pantalla A
Shade A



B
B



C
C



D
D



Cuerpo: metal hierro acabado níquel satinado
Frame: satin nickel iron metal

Bombilla recomendada: Ref 6920 / 6921 / 7921 / 3465 E-27 9W LED. Ref 1655 / 1673 / 1668 / 4364 E-27 6W LED (no incluidas)

Recommended bulb: Ref 6920 / 6921 / 7921 / 3465 E-27 9W LED. Ref 1655 / 1673 / 1668 / 4364 E-27 6W LED (not included)

Importante: ver página 240 / Important: please see page 240

Detalles: pantalla tela de algodón retorta o plisada crema o negra. Ref 6920 tiene además otros acabados. Cable transparente PVC. Plafón sistema de sujeción pantalla con imanes. Suspensión y plafón con tapa total de pergamino blanco.

Details: beige canvas cotton or beige/black pleated cotton shade. Ref.6920 has the option of using other materials. Transparent PVC wire. Plafond with magnet system. Pendant and plafond with white parchment complete diffuser.

Pared / Wall Lamp

Ref 1655
1 x 6w

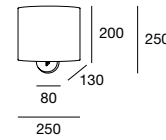

Ref 1668
1 x 6w

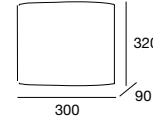

Ref 1673
1 x 6w

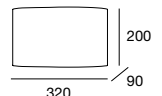

Plafón / Plafond

Ref 3465 - 40 / 45 / 50
2 x 9w

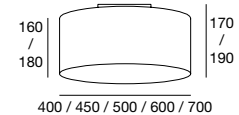

Ref 3465 - 60 / 70
4 x 9w

Mesa / Table Lamp

Ref 4364
1 x 6w

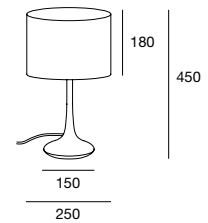

Plafón / Plafond

Ref 3466 - 35 / 40
2 x 9W

Ref 3466 - 50
4 x 9W

Ref 3468 - 35 / 40
2 x 9W

Ref 3468 - 50
4 x 9W

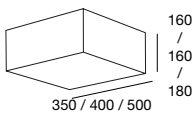

Pared / Wall Lamp

Ref 1654 - 25 / 30
1 x 6W

Ref 1662 - 25 / 30
1 x 6W

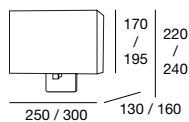

Ref 1663 - 25 / 30
1,4 x LED

Ref 1663 - 25 / 30
1 x 6W

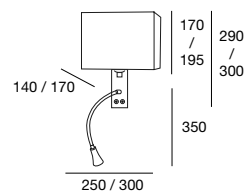

Acabado Metal
Metal Colour



Pantalla Ref 3466 / 1654 / 1663
Ref 3466 / 1654 / 1663 Shade



Pantalla Ref 3468 / 1662
Ref 3468 / 1662 Shade



Cuerpo: metal hierro acabado níquel satinado + cromo el extensible Ref 1663

Frame: satin nickel iron metal + chromed extending part Ref 1663

Detalles: pantalla tela algodón retorta o plisada. Plafones con difusor total de pergamino blanco. Sistema de sujeción de la pantalla con imanes y portalámparas de piedra. Ref 1663 lleva LED de 1,4W y transformador (incluido).

Details: beige canvas cotton or beige/black pleated cotton shade. Plafond with white parchment complete diffuser. Magnet system and stone socket Ref. 1663 with 1,4W LED + Transformer (included).

Bombilla recomendada: Ref 3466 / 3468 - 35 / 40 / 50 E-27 9W LED. Ref 1654 / 1662 / 1663 E-27 6W LED. (no incluidas)

Recommended bulb: Ref 3466 / 3468 - 35 / 40 / 50 E-27 9W LED. Ref 1654 / 1662 / 1663 E-27 6W LED. (not included)

Importante: ver página 240 / Important: please see page 240

Mesa / Table Lamp

Ref 4320 (pequeña)
1 x 6W

Ref 4321 (grande)
1 x 9W

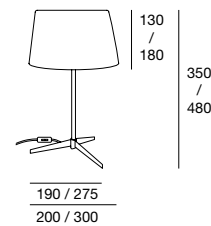

Acabado Metal
Metal Colour



Suelo / Floor Lamp

Ref 5320
1 x 11W

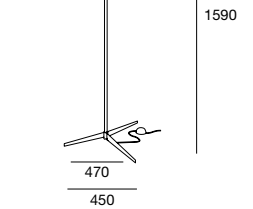

Pantalla
Shade



Cuerpo: metal hierro lacado blanco brillo.
Frame: shiny white iron metal.

Detalles: Pantalla tela algodón blanco. Cable transparente PVC.
Details: White cotton shade. Transparent PVC wire

Bombilla recomendada: Ref 4320 E-27 6W LED. Ref 4321 E-27 9W LED. Ref 5320 E-27 11W LED. (no incluidas)

Recommended bulb: Ref 4320 E-27 6W LED. Ref 4321 E-27 9W LED. Ref 5320 E-27 11W LED. (not included)

SATIN

p_166-167

Suspensión / Ceiling Lamp

Ref 6927 - 35
1 x 6w

Ref 6927 - 50
2 x 9w

Ref 6927 - 60 / 70
3 x 9w

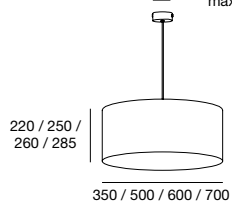

Opciones Metal
Metal Colour

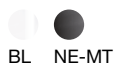

Cuerpo: metal hierro lacado y extensible en cromo.
Frame: painted iron + chromed extending part.

Bombilla recomendada: Ref 6927 - 35/ 7257 / 4377 E-27 6W LED. Ref 6927-50-60-70 / 3489 E-27 9W LED. (no incluidas)

Recommended bulb: Ref 6927 - 35/ 7257 / 4377 E-27 6W LED. Ref 6927-50-60-70 / 3489 E-27 9W LED. (not included)

Importante: ver página 240 / Important: please see page 240

Plafón / Plafond

Ref 7257
3 x 6w

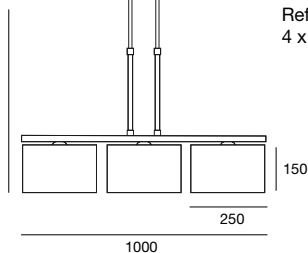

Pantalla
Shade



Ref 3489 - 50
2 x 9w

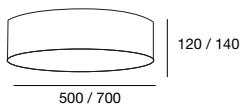

Ref 3489 - 70
4 x 9w

Mesa / Table Lamp

Ref 4377
1 x 6w

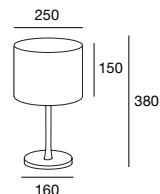

Detalles: pantalla tela de algodón electra. Cable transparente PVC. Difusor total en pergamino blanco excepto versión mesa que lo lleva parcial. Plafón con sistema de sujeción de la pantalla con imanes. Portalámparas de piedra. Ref 7257 es extensible.

Details: beige or grey electra cotton shade. Transparent PVC wire. White parchment complete diffuser except table lamp (partial). Plafond with magnet system and stone socket. Ref 7257 is extending (chromed).

QUO HOTEL

p_171

Mesa / Table Lamp

Ref 4315 pequeña / small
1 x 6W
Ref 4316 grande / big
1 x 6W

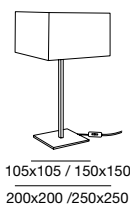

Acabado Metal
Metal Colour



Cuerpo: metal hierro acabado cromo.
Frame: chromed iron metal.

Detalles: pantalla tela algodón retorta. Cable transparente PVC.

Details: beige canvas cotton shade. Transparent PVC wire.

Bombilla recomendada: Ref 4315 /4316 E-27 6W LED. Ref 5239 E-27 11W LED.(no incluidas)

Recommended bulb: Ref 4315 /4316 E-27 6W LED. Ref 5239 E-27 11W LED. (not included)

Suelo / Floor Lamp

Ref 5239
1 x 11W

405
/
465

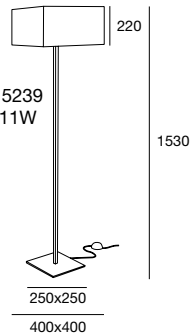

Pantalla
Shade



CHIC HOTEL

p_172

TEX

p_168-169

Suspensión / Ceiling Lamp

Ref 6935 - 35
1 x 6w

Ref 6935 - 50
2 x 9w

Ref 6935 - 80
3 x 9w

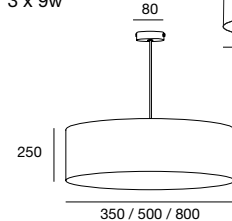

Acabado Metal
Metal Colour



Cuerpo: metal hierro níquel satinado.
Frame: satin nickel iron metal.

Bombilla recomendada: E-27 9W LED. Ref 6935-35 6W LED. (no incluidas)

Recommended bulb: E-27 9W LED. Ref 6935-35 6W LED. (not included)

Importante: ver página 240 / Important: please see page 240

Plafón / Plafond

Ref 3490 - 50
2 x 9w

Ref 3490 - 70
4 x 9w

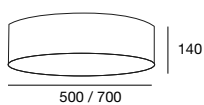

Pantalla Ref 6935 / 3490 Lamitex
Ref 6935 / 3490 Shade Lamitex



Ref 3480 - 40 / 50
2 x 9w

Ref 3480 - 60 / 70
4 x 9w

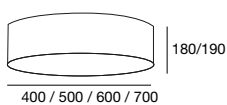

Pantalla Ref 3480 acrílico
Ref 3480 Shade acrylic



Detalles: pantalla diversos acabados según referencias. Cable transparente PVC. Plafón con sistema de sujeción de la pantalla con imanes. Portalámparas de piedra.

Details: lamitex material for pendant shade and narrow plafond options. Acrylic or cotton materials for wide plafond. Transparent PVC wire. Magnet system and stone socket.

Ref 3486 - 40 / 45 / 50
2 x 9w

Ref 3486 - 60 / 70
4 x 9w

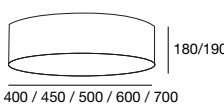

Pantalla Ref 3486 cotton
Ref 3486 Shade cotton



Suelo / Floor Lamp

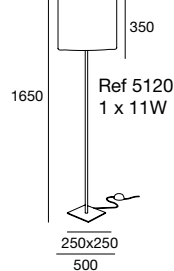

Suspensión / Ceiling Lamp

Ref 6120 - 35 / 50
1 x 11W

Acabado Metal
Metal Colour



Cuerpo: metal hierro acabado níquel satinado
Frame: satin nickel iron metal

Detalles: Pantalla tela linón crema. Cable transparente PVC.

Details: Beige linen shade. Transparent PVC wire

Bombilla recomendada: Ref 4116 E-27 6W LED. Ref 6120 / 4120 / 5120 E-27 11W LED.(no incluidas)

Recommended bulb: Ref 4116 E-27 6W LED. Ref 6120 / 4120 / 5120 E-27 11W LED. (not included)

Importante: ver página 240 / Important: please see page 240

Mesa / Table Lamp

Ref 4116 (pequeña)
1 x 6W
Ref 4120 (grande)
1 x 11W

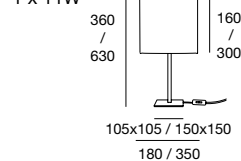

Pantalla
Shade



Mesa / Table Lamp

Ref 4434 pequeña / small
1 x 9W
Ref 4435 grande / big
1 x 9W

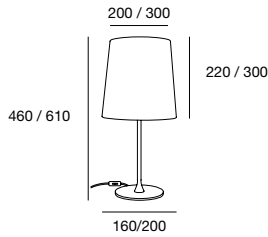

Acabado Metal
Metal Colour



NI

Pantalla
Shade



RE

Cuerpo: metal hierro acabado níquel satinado.
Frame: satin nickel iron metal.

Detalles: pantalla tela algodón retorta. Cable transparente PVC.

Details: beige canvas cotton shade. Transparent PVC wire.

Bombilla recomendada: E-27 9W LED. (no incluidas)
Recommended bulb: E-27 9W LED. (not included)

Suspensión / Ceiling Lamp

Ref 6812 - 30 / 45
1 x 9w

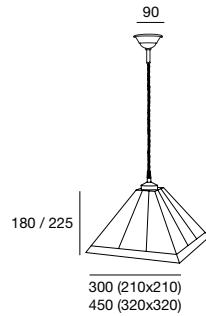

Acabado Metal
Metal Colour



MA

Cuerpo: metal hierro acabado pintura marrón.
Frame: brown painted iron metal.

Detalles: tulipas de Tiffany. Cable trenzado marrón en las de suspensión. Cable negro PVC en las de sobremesa.

Details: tiffany shades. Brown plaited cable for pendants. Black PVC wire for tablelamps.

Ref 7183 - 3 / 4
3 / 4 x 6w

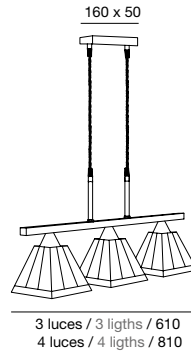

Pared / Wall Lamp

Ref 1661 - 1
1 x 6w

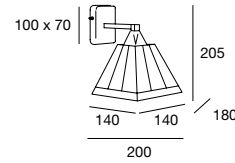

Ref 1661 - 2 / 3
2 / 3 x 6w

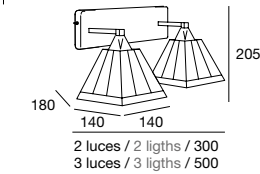

Bombilla recomendada: Ref 1661 / 7183 / 4254 E-14 6W LED. Ref 4255 E-27 6W LED. Ref 6812 E-27 9W LED. (no incluidas)

Recommended bulb: Ref 1661 / 7183 / 4254 E-14 6W LED. Ref 4255 E-27 6W LED. Ref 6812 E-27 9W LED. (not included)

Importante: ver página 240 / Important: please see page 240

Mesa / Table Lamp

Ref 4254 pequeña / small
1 x 6w

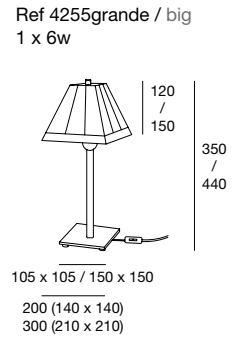

Ref 4255 grande / big
1 x 6w

Suspensión / Ceiling Lamp

Ref 7161 - 3 / 4
3 / 4 x 6w

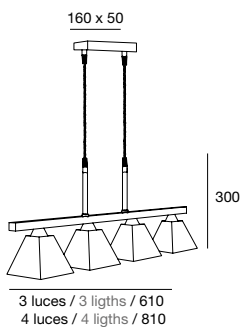

Opciones Metal
Metal Colour

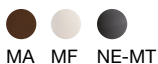

MA MF NE-MT

Cuerpo: metal hierro acabado pintura.
Frame: painted iron metal.

Detalles: pantalla tela algodón retorta. Cable trenzado marrón para la suspensión. Acabados NE-MT y MA Cable negro PVC y acabado MF Cable transparente PVC.

Details: beige canvas cotton shade. Brown plaited cable for pendant. Black PVC wire for brown and black table lamps and transparent PVC wire for ivory table lamp.

Suelo / Floor Lamp

Ref 5161
1 x 11w

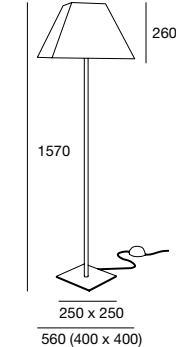

Pantalla
Shade



RE

Mesa / Table Lamp

Ref 4461 pequeña / small
1 x 9w

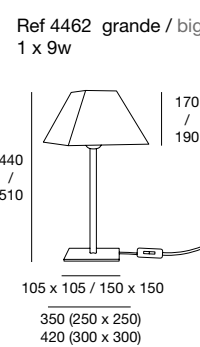

Bombilla recomendada: Ref 1461 / 1462 / 7161 E-14 6W LED. Ref 4461 E-27 6W LED. Ref 446 E-27 9W LED. Ref 5161 E-27 11W LED. (no incluidas)

Recommended bulb: Ref 1461 / 1462 / 7161 E-14 6W LED. Ref 4461 E-27 6W LED. Ref 446 E-27 9W LED. Ref 5161 E-27 11W LED. (not included)

Importante: ver página 240 / Important: please see page 240

Pared / Wall Lamp

Ref 1461 - 1 / 2 / 3
1 / 2 / 3 x 6w

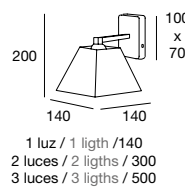

Ref 1462 - 1 / 2 / 3
1 / 2 / 3 x 6w

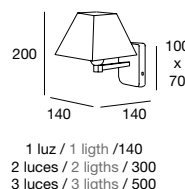

Pared / Wall Lamp

Ref 1460
1 x 6w

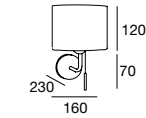

Mesa / Table Lamp

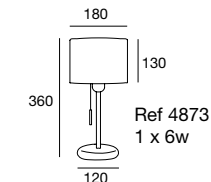

Acabado Metal
Metal Colour



BL-MT

Cuerpo: metal hierro acabado blanco mate texturado.
Frame: matte white painted iron metal.

Detalles: pantalla tela algodón. Cable transparente PVC. Interruptor de tirador con detalle cromado.
Details: clear or dark grey cotton. Transparent PVC wire. Chain switch with chromed ornament.

Bombilla recomendada: Ref 1460 / 4873 E-27 6W LED. Ref 5209 E-27 9W LED. (no incluidas)
Recommended bulb: Ref 1460 / 4873 E-27 6W LED. Ref 5209 E-27 9W LED. (not included)

Suelo / Floor Lamp

Ref 5209
1 x 9w

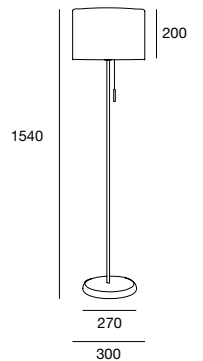

Pantalla
Shade



GR GO

BLANK

p_178-179

Suspensión / Ceiling Lamp

Ref 7954 - 3 / 5
3 / 5 x 6w

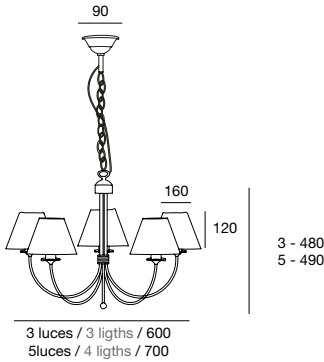

Opciones Metal
Metal Colour



Pantallal
Shade



Cuerpo: metal hierro acabado pintura.

Frame: painted iron metal.

Detalles: pantalla tela algodón crema. Acabados NE-MT y MA Cable negro PVC y acabado MF Cable transparente PVC.

Details: Beige cotton shade. Black PVC wire for brown and black table lamps and transparent PVC wire for ivory table lamp.

Pared / Wall Lamp

Ref 1459
1 x 6w

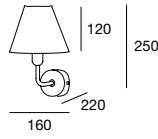

Mesa / Table Lamp

Ref 4872
1 x 6w LED

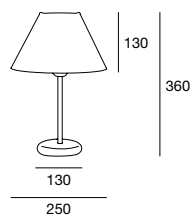

Suelo / Floor Lamp

Ref 5208
1 x 11w

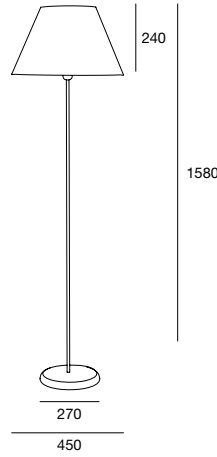

Bombilla recomendada: Ref 1459 / 7954 E-14 6W LED. Ref 4872 E-27 6W LED. Ref 5208 E-27 11W LED. (no incluidas)

Recommended bulb: Ref 1459 / 7954 E-14 6W LED. Ref 4872 E-27 6W LED. Ref 5208 E-27 11W LED. (not included)

Importante: ver página 240 / Important: please see page 240

VALLISE

p_181

Mesa / Table Lamp

Ref 4436
1 x 9W

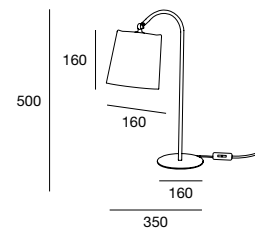

Opciones Metal
Metal Colour



Suelo / Floor Lamp

Ref 5436
1 x 9W

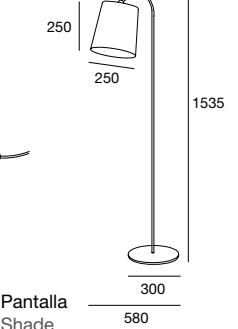

Pantalla
Shade



Cuerpo: metal hierro acabado blanco mate texturado o negro mate texturado.

Frame: matte white or matte black painted iron metal.

Detalles: pantalla tela lino crudo orientable.. Cable transparente o negro PVC (según opción).

Details: adjustable beige linen shade. Transparent or black wire PVC.

Bombilla recomendada: E-27 9W LED. (no incluida)

Recommended bulb: E-27 9W LED. (not included)

CARRÁ

p_182

Suspensión / Ceiling Lamp

Ref 6649
1 x 11w

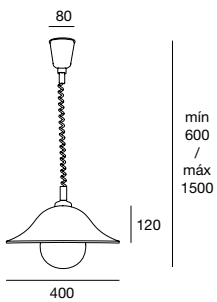

Opciones Metal
Metal Colour



Cuerpo: metal hierro acabado níquel satinado o cuero envejecido.

Frame: satin nickel or antic brass iron metal.

Detalles: cristal opal mate. Sube y baja con asa. Details: Opal matte glass. Up and down system with handle.

Bombilla recomendada: Ref 6680 E-14 6W LED. Ref 6649 E-27 11W LED. Ref 6694 E-27 6W LED. (no incluidas)

Recommended bulb: Ref 6680 E-14 6W LED. Ref 6649 E-27 11W LED. Ref 6694 E-27 6W LED. (not included)

Plafón / Plafond

Ref 6694
2 x 6w

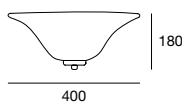

Pared / Wall Lamp

Ref 6680
1 x 6w

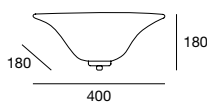

Cristal
Glass



CIRCA

p_183

Plafón / Plafond

Ref 3460 - 20 / 25
1 x 6w LED

Ref 3460 - 30
2 x 6w LED

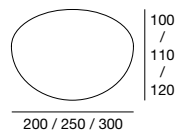

Cristal
Glass



Cuerpo: soporte zincado
Frame: zink support

Detalles: cristal opal mate o brillo. Cogida de soporte de cristal mediante pestañas giratorias.

Details: shiny or matte opal glass. System to hold the glass by using gyrotary clips.

Bombilla recomendada: Ref 3460 E-27 6W LED. (no incluidas)

Recommended bulb: Ref 3460 E-27 6W LED. (not included)

ULM

p_184

Suspensión / Ceiling Lamp

Ref 6654
1 x 11w

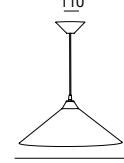

Cristal
Glass



Cuerpo: cada modelo tiene un acabado distinto. Ref 6656 acabado en blanco, Ref 6654 acabado en plástico gris y Ref 6899 acabado en metal níquel satinado.

Frame: each reference has a different color. Up & Down Ref 6656 is white, pendant Ref 6654 is grey and the pendant Ref 6899 is satin nickel.

Detalles: Cristal opal mate. Acabado según fotografía.

Details: opal mate glass. View photo.

Bombilla recomendada: Ref 6656 / 6654 E-27 11W LED. Ref 6899 E-27 9W LED. (no incluidas)

Recommended bulb: Ref 6656 / 6654 E-27 11W LED. Ref 6899 E-27 9W LED. (not included)

Importante: ver página 240 / Important: please see page 240

Pared / Wall Lamp

Ref 1652
1x 1,4w LED

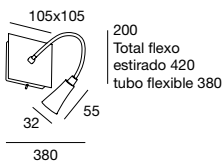

Ref 1653
1x 1,4w LED

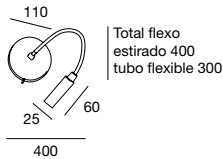

Ref 1696
1x 1,4w LED

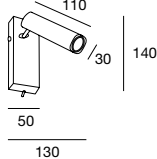

Ref 1703
1x 6w

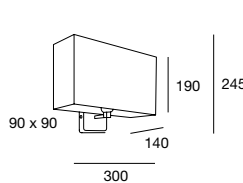

Ref 1704
2x 6w

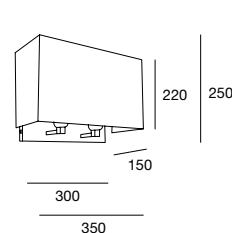

Ref 1695
1x 1,4w LED

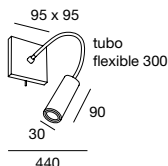

Ref 1694
1x 1,4w LED

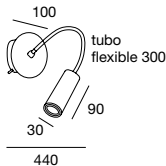

Acabado Metal Metal Colour Madera Wood



Cuerpo: metal hierro acabado níquel satinado y cromo la parte flexible.

Frame: satin nickel iron metal + chromed extending part.

Detalles: madera de haya. Interruptor metálico. Brazos flexibles y/o con rótula giratoria.

Details: beech wood. Metal switch. Flexible arms and/or gyrotary kneecap.

Bombilla recomendada: bombilla y transformador incluido: 1,4W LED. 4000K (130 lumens)

Recommended bulb: bulb + transformer included 1,4W LED. 4000K (130 lumens)

Opciones Metal Metal Colour

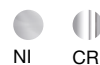

Pantalla Shade



Cuerpo: metal hierro acabado níquel satinado o cromo.

Frame: satin nickel or chrome iron metal

Bombilla recomendada: 6W LED (no incluida)

Recommended bulb: 6W LED (not included)

Pared / Wall Lamp

Ref 1706
1x 1,4w LED
1x 6w

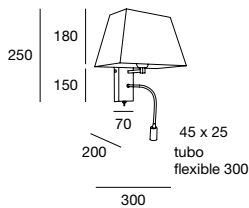

Ref 1698
1x 1,4w LED
1x 6w

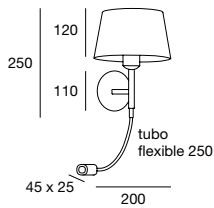

Ref 1697
1x 1,4w LED
1x 6w

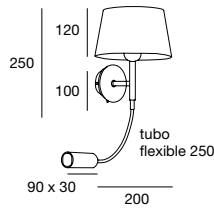

Ref 1705
1x 1,4w LED
1x 6w

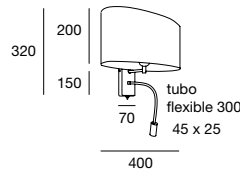

Ref 1699
1x 1,4w LED
1x 6w

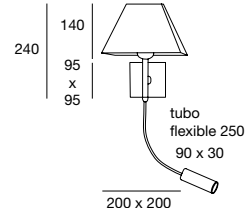

Opciones Metal Metal Colour



Pantalla Shade



Cuerpo: metal hierro acabado blanco mate texturado o negro mate texturado.

Frame: mate white or mate black painted iron metal

Detalles: Interruptor metálico.

Details: metal switch.

Bombilla recomendada: LED y transformador incluido: 1,4W LED. 3000K (120 lumens). 6W LED (no incluida)

Recommended bulb: bulb + transformer included 1,4W LED. 3000K (120 lumens). 6W LED (not included)

Ref 1702
1x 6w

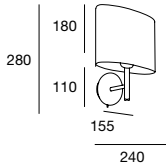

Ref 1701
1x 6w

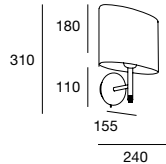

Ref 1700
1x 1,4w LED
1x 6w

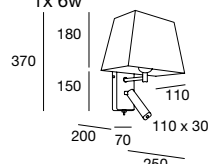

Acabado Metal Metal Colour



Madera Wood



Pantalla Ref 1697/98 Ref 1701 /02/05 Shade Ref 1697/98 Ref 1701 /02/05



Pantalla Ref 1699 Ref 1700 Shade Ref 1699 Ref 1700



Cuerpo: metal hierro acabado níquel satinado y cromo la parte flexible.

Frame: satin nickel iron metal + chromed extending part.

Detalles: madera de haya. Interruptor metálico. Brazos flexibles y/o con rótula giratoria.

Details: beech wood. Metal switch. Flexible arms and/or gyrotary kneecap.

Bombilla recomendada: bombilla y transformador incluido: 1,4W LED. 4000K (130 lumens). 6W LED (no incluida) Ref 1698 / 1705 3000K (120 lumens)

Recommended bulb: bulb + transformer included 1,4W LED. 4000K (130 lumens). 6W LED (not included) Ref 1698 / 1705 3000K (120 lumens)

Importante: ver página 240 / Important: please see page 240

NICO

p_185

Suspensión / Ceiling Lamp

Ref 6775
1 x 9w

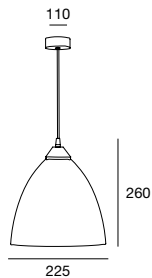

6775_Cristal
6775_Glass



Cuerpo: plástico gris.
Frame: grey plastic.

Detalles: cristal decorado en colores.
Details: color decorated glass.

Bombilla recomendada: Ref 6775 E-27 9W LED.
Ref 6319 E-27 6W LED. (no incluidas)

Recommended bulb: Ref 6775 E-27 9W LED.
Ref 6319 E-27 6W LED. (not included)

Importante: ver página 240 / Important: please see page 240

Ref 6319
1 x 6w

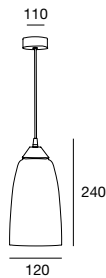

6319_Cristal
6319_Glass



LOUVRE

p_186-187

Pared / Wall Lamp

Ref 1575- 25
1 x 40w

Ref 1575- 30 / 40 / 45
2 x 40w

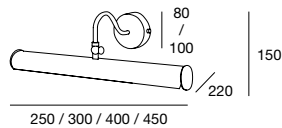

Opciones Metal
Metal Colour



Cuerpo: metal hierro para los acabados níquel satinado y cobre satinado. Metal latón para los acabados anticuario y latón satinado.

Frame: iron metal for satin nickel and satin copper colors. Brass metal for antiquary and satin brass colors.

Detalles: pantalla orientable. Para tamaños superiores a los estándar, consultar al departamento de atención al cliente.

Details: adjustable shade. For bigger sizes than the standard, please contact our Customer Support Department.

Bombilla recomendada: 40W (incluida)
Recommended bulb: 40W (included)

ALUMINUM

p_200-201

Suspensión / Ceiling Lamp

Ref 50598
1 x 9w

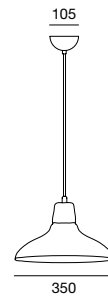

Ref 50665
1 x 9w

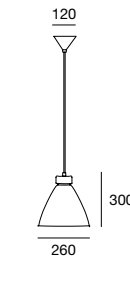

Ref 50028
1 x 9w

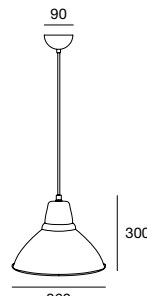

Cuerpo: metal aluminio.
Frame: aluminium metal.

Detalles: cable PVC según foto. Estándar 1400mm.
Details: PVC wire as in the photo. Standard 1400mm.

Bombilla recomendada: E-27 9W LED. (no incluidas)
Recommended bulb: E-27 9W LED. (not included)

Importante: ver página 240 / Important: please see page 240

KAMI

p_196-199

Suspensión / Ceiling Lamp

Ref 58408
1 x 9w

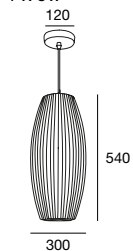

Ref 58411
1 x 9w



Ref 58410
1 x 9w

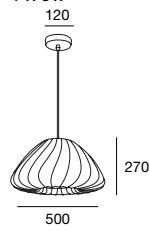

Ref 58406
1 x 9w

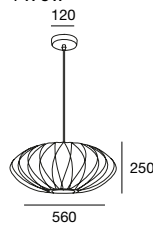

Ref 58412
1 x 9w

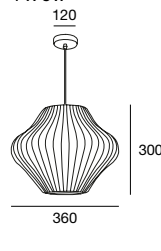

Ref 58413
1 x 9w

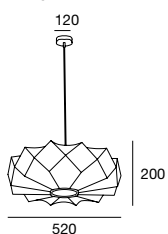

Ref 58414
1 x 9w

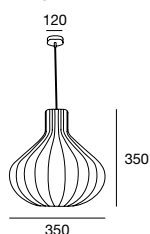

Ref 58404
1 x 9w

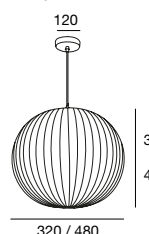

Ref 58405
1 x 9w

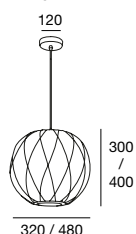

Acabado Metal
Metal Colour



Cuerpo: metal níquel satinado. Pantalla de resina lavable.

Frame: satin nickel metal. Washable polyresin material.

Detalles: cable PVC transparente. Estándar 1400mm.
Details: PVC transparent wire. Standard 1400 mm.

Importante: ver página 240 / Important: please see page 240

Mesa / Table Lamp

Ref 58401
1 x 9w

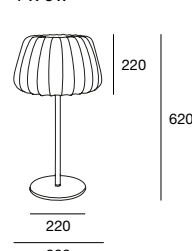

Ref 58403
1 x 9w

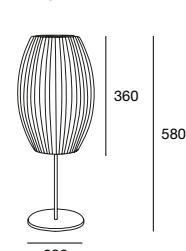

Ref 58402
1 x 6w

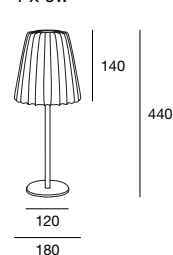

Bombilla recomendada: E-27 9W LED. Ref 58402 E-27 6W LED. (no incluidas)

Recommended bulb: E-27 9W LED. Ref 58402 E-27 6W LED. (not included)

