

*Inspiration  
book*

**LOYRATIME**

*loyratime.com*

# 005 los

librerías  
bookcase

# 043 Moss

contenedores  
containers

# 077 Yoko

librerías  
bookcase

# 103 Q

contenedores a pared  
wall containers



# los

librerías  
bookcase

# los 01

5992\_P.132

**ACABADOS**

- ESTRUCTURA 101 arena mate
- APOYOS 113 antracita mate
- PUERTA MADERA PLAY 520 roble ceniza
- PUERTAS CRISTAL AIR metal negro, cristal dark grey

LAN ALFOMBRA crudo

\*El precio no incluye iluminación led

**FINISHES**

- STRUCTURE 101 matt arena
- FREE INNER DIVIDER 113 matt antracita
- PLAY WOOD DOOR 520 oak
- AIR GLASS DOORS black metal, dark grey glass

LAN CARPET crudo

\*Price does not include led lighting

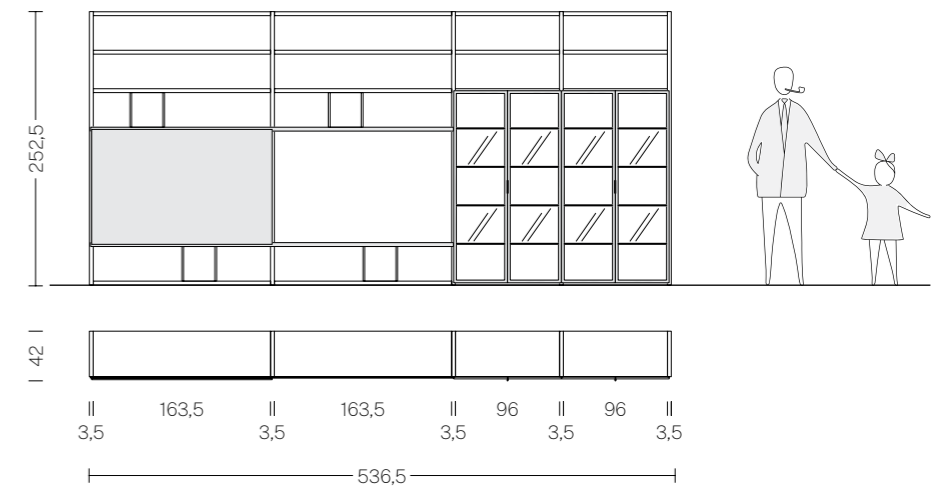

# los 02

6346\_P.133

**ACABADOS**

ESTRUCTURA 530 roble humo, 114 gris mate  
APOYOS 530 roble humo  
PUERTAS MADERA PLAY 114 gris mate  
CAJONES IN 141 oliva mate

LAN ALFOMBRA crudo

**FINISHES**

STRUCTURE 530 oak, 114 matt gris  
FREE INNER DIVIDER 530 oak  
PLAY WOOD DOORS 114 matt gris  
IN DRAWERS 141 matt oliva

LAN CARPET crudo

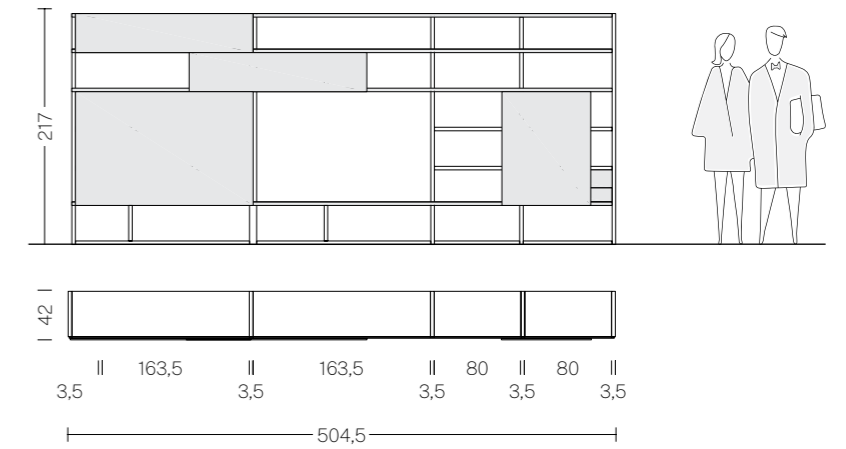



# los 03

6136\_P.134

**ACABADOS**

ESTRUCTURA 420 nogal nut, 112 grafito mate  
 PUERTAS MADERA STEP 101 arena mate  
 CAJONES STEP 112 grafito mate, tirador metal grafito

LAN ALFOMBRA crudo

\*El precio no incluye iluminación led

**FINISHES**

STRUCTURE 420 walnut, 112 matt grafito  
 STEP WOOD DOORS 101 matt arena  
 STEP DRAWERS 112 matt grafito, grafito metal handle

LAN CARPET crudo

\*Price does not include led lighting

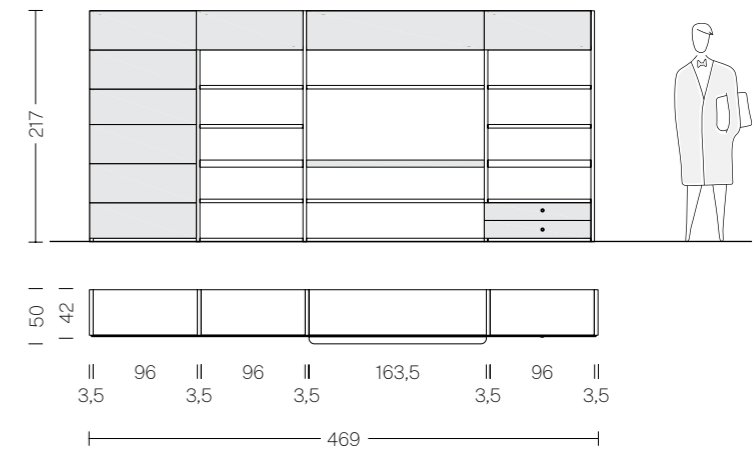



# Ios 04

5524\_P.135

**ACABADOS**  
 ESTRUCTURA 100 blanco mate  
 PUERTAS CRISTAL AIR metal 100 blanco mate, cristal transparente

LAN ALFOMBRA crudo

\*El precio no incluye iluminación led

**FINISHES**  
 STRUCTURE 100 matt blanco  
 AIR GLASS DOORS 100 matt blanco metal, transparent glass

LAN CARPET crudo

\*Price does not include led lighting

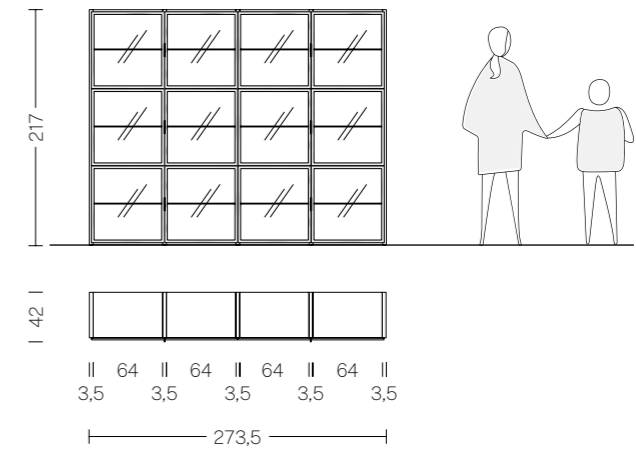



# los 05

4913\_P.136

**ACABADOS**

ESTRUCTURA 112 grafito mate, 106 tórtola mate, 620 eucalipto ahumado  
 PUERTAS CRISTAL ONLY metal negro, cristal dark grey  
 CAJONES IN / DRAWERS IN 620 eucalipto ahumado, tirador metal negro

LAN ALFOMBRA antracita

\*El precio no incluye iluminación led

**FINISHES**

STRUCTURE 112 matt graphite, 106 matt tortola, 620 smoked eucalyptus  
 ONLY GLASS DOORS black metal, dark grey glass  
 DRAWERS IN 620 eucalipto, black metal handle

LAN CARPET antracita

\*Price does not include led lighting

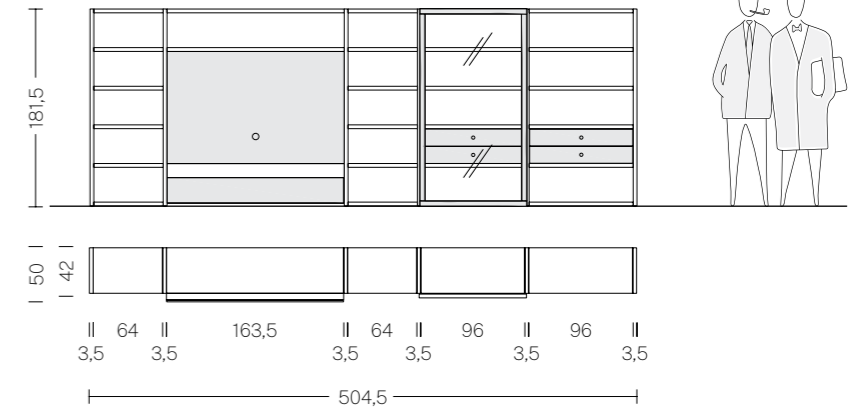

# los 06

4540\_P.137

**ACABADOS**

ESTRUCTURA 510 roble claro, 101 arena mate, 113 antracita mate  
PUERTAS CRISTAL AIR metal negro, cristal transparent

LAN ALFOMBRA crudo

\*El precio no incluye iluminación led

**FINISHES**

STRUCTURE 510 oak, 101 matt arena, 113 matt antracita  
AIR GLASS DOORS black metal, transparent glass

LAN CARPET crudo

\*Price does not include led lighting

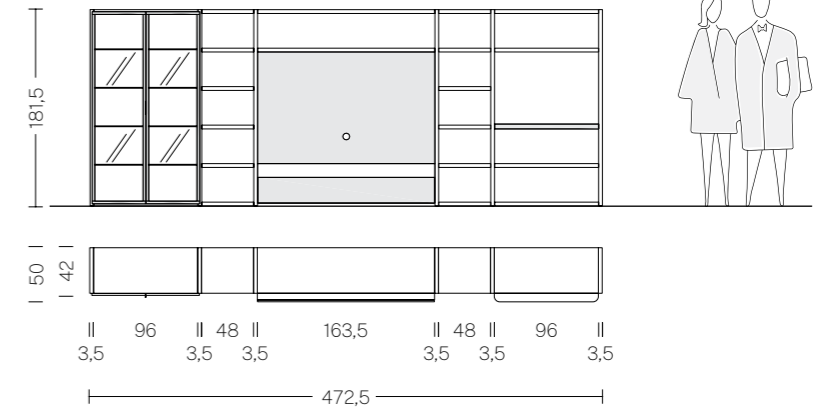

# los 07

4171\_P.138

**ACABADOS**

ESTRUCTURA 154 plomo mate  
PUERTA MADERA ONLY 530 roble humo  
PUERTA CRISTAL AIR metal negro, cristal dark grey  
CAJONES IN 113 antracita mate

LAN ALFOMBRA crudo

\*El precio no incluye iluminación led

**FINISHES**

STRUCTURE 154 matt plomo  
ONLY WOOD DOOR 530 oak  
AIR GLASS DOOR black metal, cristal dark grey  
IN DRAWERS 113 matt antracita

LAN CARPET crudo

\*Price does not include led lighting

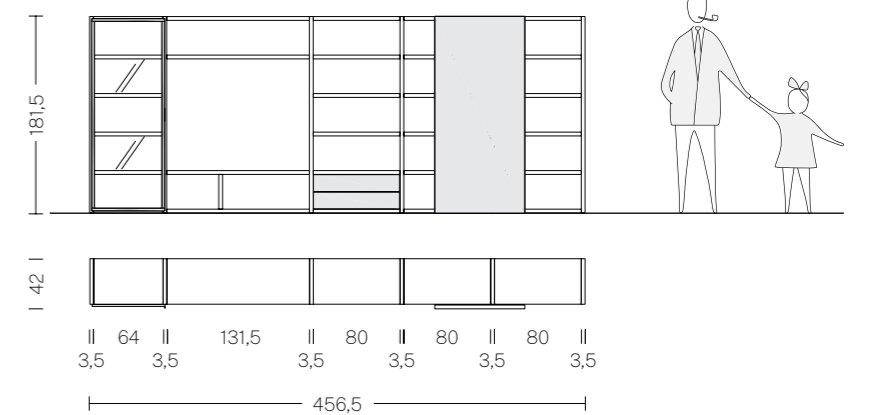

# los 08

4412\_P.139

**ACABADOS**

ESTRUCTURA 520 roble ceniza, 112 grafito mate  
 APOYOS 520 roble ceniza, 112 grafito mate  
 PUERTA CRISTAL PLAY cristal dark grey  
 CAJONES IN 112 grafito mate  
 CUBO DEC MULTIMEDIA 124 terra mate

LAN ALFOMBRA gris, crudo

\*El precio no incluye iluminación led

**FINISHES**

STRUCTURE 520 oak, 112 matt grafito  
 FREE INNER DIVIDERS 520 oak, 112 matt grafito  
 PLAY GLASS DOOR dark grey glass  
 IN DRAWERS 112 matt grafito  
 DEC BOX MULTIMEDIA 124 matt terra

LAN CARPET gris, crudo

\*Price does not include led lighting

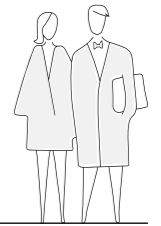

# los 09

3760\_P.140

**ACABADOS**

ESTRUCTURA 101 arena mate  
CAJONES IN 101 arena mate, tirador metal negro  
CUBOS DEC 520 roble ceniza  
PUERTA CRISTAL AIR metal negro, cristal dark grey

LAN ALFOMBRA crudo

\*El precio no incluye iluminación led

**FINISHES**

STRUCTURE 101 matt arena  
IN DRAWERS 101 matt arena, black metal handle  
DEC BOX 520 oak  
AIR GLASS DOOR black metal, dark grey glass

LAN CARPET crudo

\*Price does not include led lighting





# los 10

2299\_P.141

**ACABADOS**  
 ESTRUCTURA 530 roble humo  
 ENCIMERA 112 grafito mate  
 PUERTA MADERA PLAY 101 arena mate  
 CAJONES IN 112 grafito mate

LAN ALFOMBRA crudo

**FINISHES**  
 STRUCTURE 530 oak  
 TOP COVER 112 matt grafito  
 PLAY WOOD DOOR 101 matt arena  
 IN DRAWERS 112 matt grafito

LAN CARPET crudo





# los 11

3706\_P.142

**ACABADOS**  
ESTRUCTURA 122 polvo mate  
CUBOS DEC 113 antracita mate

LAN ALFOMBRA antracita

**FINISHES**  
STRUCTURE 122 matt polvo  
DEC BOX 113 matt antracita

LAN CARPET antracita

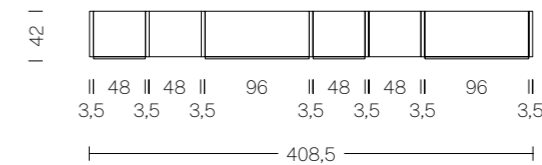
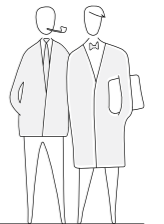
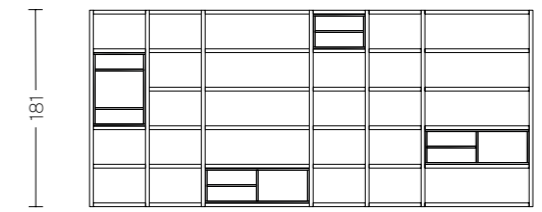



# los 12

4342\_P.143

**ACABADOS**  
 ESTRUCTURA 530 roble humo, 124 terra mate, 113 antracita mate  
 PUERTAS CRISTAL AIR metal negro, cristal dark grey

LAN ALFOMBRA antracita

\*El precio no incluye iluminación led

**FINISHES**  
 STRUCTURE 530 oak, 124 matt terra, 113 matt antracita  
 AIR GLASS DOORS black metal, dark grey glass

LAN CARPET antracita

\*Price does not include led lighting

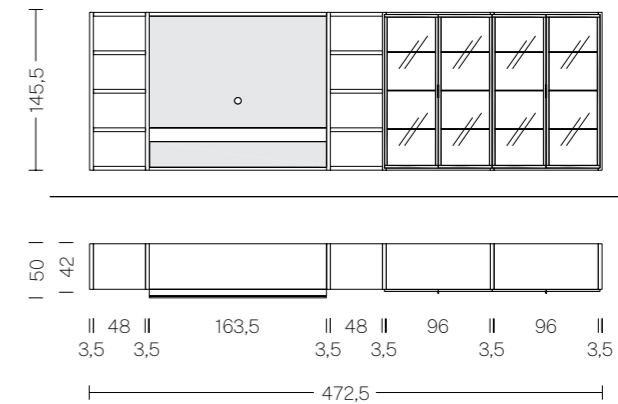
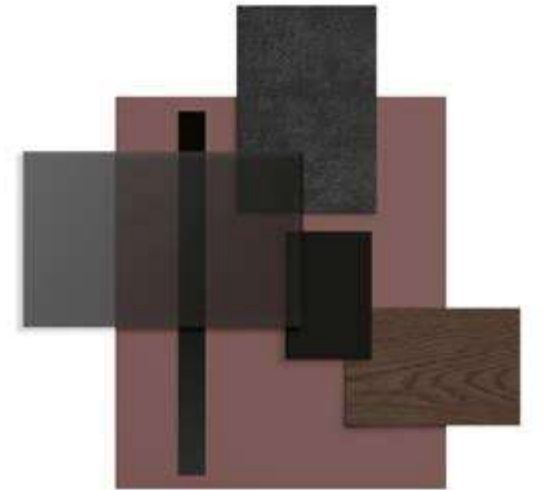



# los 13

3144\_P.144

**ACABADOS**

**ESTRUCTURA**

114 gris mate, 530 roble humo, 112 grafito mate

**PUERTAS CRISTAL AIR** metal negro, cristal dark grey

LAN ALFOMBRA gris

\*El precio no incluye iluminación led

**FINISHES**

**STRUCTURE** 114 matt gris, 530 oak, 112 matt grafito

**AIR GLASS DOORS** black metal, dark grey glass

LAN CARPET gris

\*Price does not include led lighting

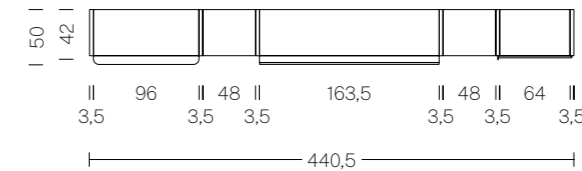
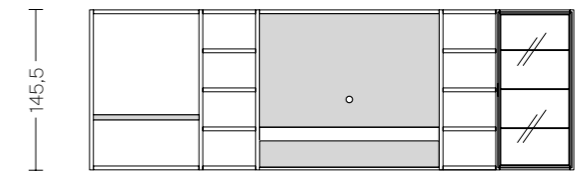

# los 14

3568\_P.145

**ACABADOS**

ESTRUCTURA 510 roble claro, 101 arena mate  
 PUERTAS MADERA STEP 101 arena mate  
 CAJONES IN 143 cactus mate, tirador metal negro

LAN ALFOMBRA gris

\*El precio no incluye iluminación led

**FINISHES**

STRUCTURE 510 oak, 101 matt arena  
 STEP WOOD DOOR 101 matt arena  
 IN DRAWERS 143 matt cactus, black metal handle

LAN CARPET gris

\*Price does not include led lighting

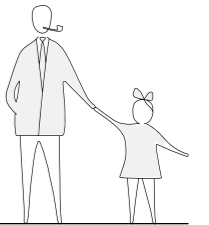
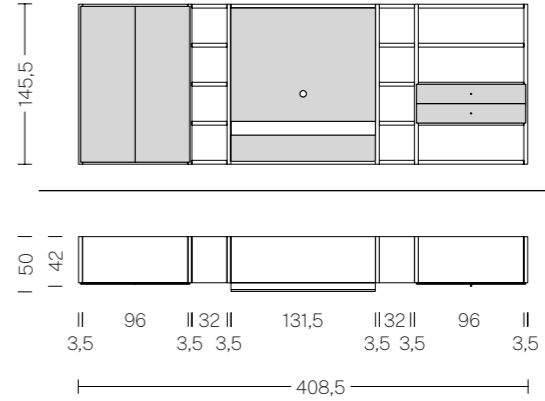



# los 15

2706\_P.146

**ACABADOS**

ESTRUCTURA 106 tórtola mate  
 PUERTAS CRISTAL AIR metal negro, cristal transparente  
 CUBO MULTIMEDIA DEC 510 roble claro  
 CAJONES IN 106 tórtola mate, tiradores metal negro

LAN ALFOMBRA crudo

\*El precio no incluye iluminación led

**FINISHES**

STRUCTURE 106 matt tórtola  
 AIR GLASS DOORS black metal, transparent glass  
 MULTIMEDIA CUBE DEC 510 oak  
 IN DRAWERS 106 matt tórtola, black metal handles

LAN CARPET crudo

\*Price does not include led lighting

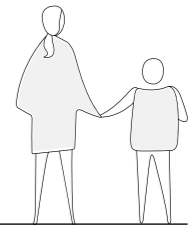
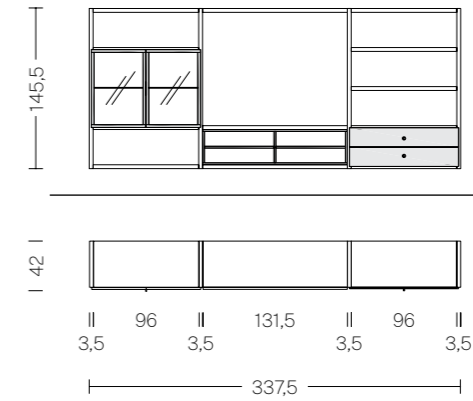

# los 16

2205\_P.147

**ACABADOS**

ESTRUCTURA 112 grafito mate  
ENCIMERA 112 grafito mate  
PUERTA CRISTAL PLAY cristal dark grey  
CAJONES IN 112 grafito mate, tiradores metal negro

LAN ALFOMBRA antracita

**FINISHES**

STRUCTURE 112 matt grafito  
TOP COVER 112 matt grafito  
PLAY GLASS DOOR dark grey glass  
IN DRAWERS 112 matt grafito, black metal handles

LAN CARPET antracita

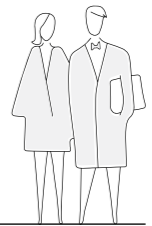
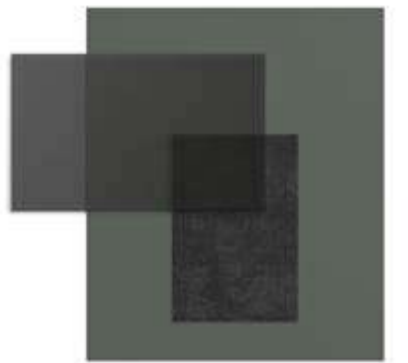

# los 17

2539\_P.148

**ACABADOS**

- ESTRUCTURA 520 roble ceniza
- TRASERA 100 blanco mate
- ENCIMERA 520 roble ceniza
- PUERTA CRISTAL PLAY metal negro, cristal dark grey
- CAJONES IN 100 blanco mate

LAN ALFOMBRA antracita

\*El precio no incluye iluminación led

**FINISHES**

- STRUCTURE 520 oak
- REAR PANEL 100 matt blanco
- TOP COVER 520 oak
- PLAY GLASS DOOR black metal, dark grey glass
- IN DRAWERS 100 matt blanco

LAN CARPET antracita

\*Price does not include led lighting

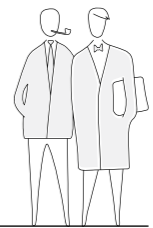

|| 96 || 96 || 48 || 48 ||  
3,5 3,5 3,5 3,5 3,5

305,5

# los 18

2173\_P. 149

**ACABADOS**

ESTRUCTURA 530 roble humo  
ENCIMERA 530 roble humo  
PUERTAS MADERA PLAY 112 grafito mate  
CAJONES IN 114 gris mate, tiradores metal 114 gris mate

LAN ALFOMBRA antracita

**FINISHES**

STRUCTURE 530 oak  
TOP COVER 530 oak  
PLAY WOOD DOORS 112 matt graphite  
IN DRAWERS 114 matt grey, metal handles 114 matt grey

LAN CARPET antracita

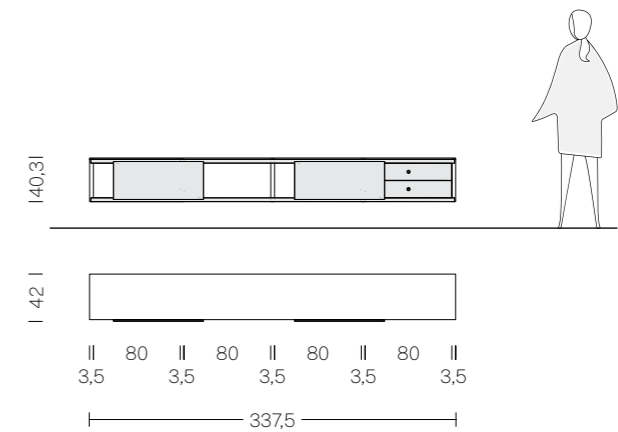



# Moss

contenedores  
containers



# Moss 01

1828\_P.150

### ACABADOS

- ESTRUCTURA EXTERIOR 100 blanco mate
- ESTRUCTURA INTERIOR 100 blanco mate
- PUERTAS CRISTAL BET metal 100 blanco mate, cristal transparente
- CAJONES 100 blanco mate, tiradores metal negro
- PATAS METÁLICAS metal negro

LAN ALFOMBRA antracita

### FINISHES

- OUTER STRUCTURE 100 matt blanco
- INNER STRUCTURE 100 matt blanco
- BET GLASS DOORS 100 matt blanco metal, transparent glass
- DRAWERS 100 matt blanco, black metal handles
- METAL LEGS black metal

LAN CARPET antracita

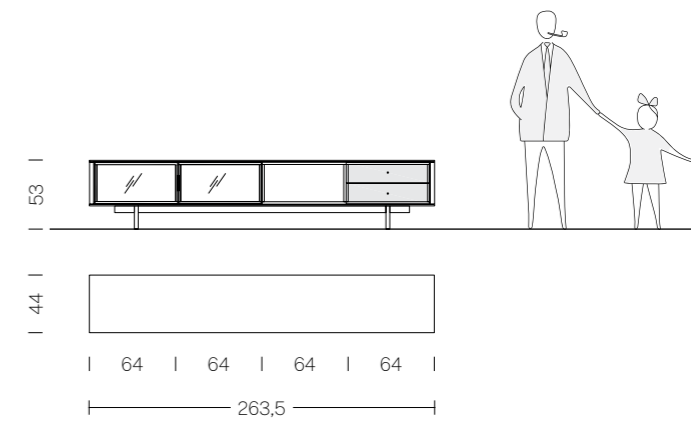



# Moss 02

1516\_P. 151

**ACABADOS**

- ESTRUCTURA EXTERIOR 124 terra mate
- ESTRUCTURA INTERIOR 114 gris mate
- ESTANTE SUELTO 114 gris mate
- CAJONES 124 terra mate, tiradores metal negro
- PUERTAS MADERA 124 terra mate
- PUERTA CRISTAL BET metal negro, cristal dark grey

LAN ALFOMBRA crudo

**FINISHES**

- OUTER STRUCTURE 124 matt terra
- INNER STRUCTURE 114 matt gris
- LOOSE SHELF 114 matt gris
- DRAWERS 124 matt terra, black metal handles
- WOOD DOORS 124 matt terra, glass dark grey
- BET GLASS DOOR black metal, dark grey glass

LAN CARPET crudo

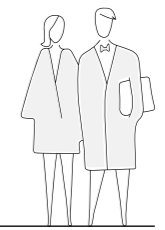
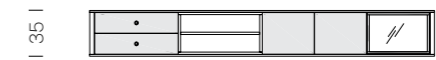

| 64 | 64 | 80 | 48 |

263,5



## Moss 03

1114\_P.152

### ACABADOS

ESTRUCTURA EXTERIOR 530 roble humo  
ESTRUCTURA INTERIOR 114 gris mate  
PUERTAS MADERA 112 grafito brillo

LAN ALFOMBRA antracita

### FINISHES

OUTER STRUCTURE 530 oak  
INNER STRUCTURE 114 matt gris  
WOOD DOORS 112 high gloss grafito

LAN CARPET antracita

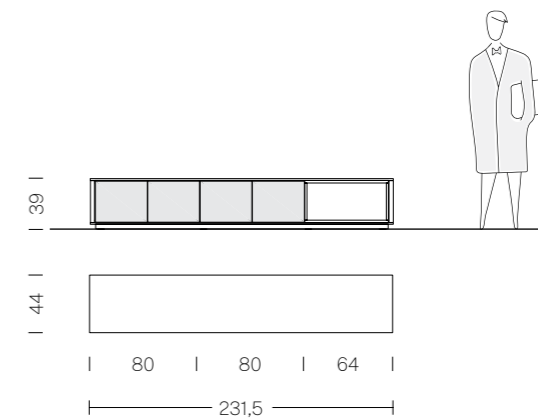



# Moss 04

1244\_P.153

**ACABADOS**

- ESTRUCTURA EXTERIOR 620 eucalipto ahumado
- ESTRUCTURA INTERIOR 101 arena mate
- ESTANTE cristal transparente
- PUERTA MADERA 620 eucalipto ahumado
- CAJONES 620 eucalipto ahumado, tiradores metal negro
- PATAS METÁLICAS metal negro

LAN ALFOMBRA antracita

**FINISHES**

- OUTER STRUCTURE 620 smoked eucalyptus
- INNER STRUCTURE 101 matt arena
- SHELF transparent glass
- WOOD DOOR 620 smoked eucalyptus
- DRAWERS 620 smoked eucalyptus, black metal handles
- METAL LEGS black metal

LAN CARPET antracita

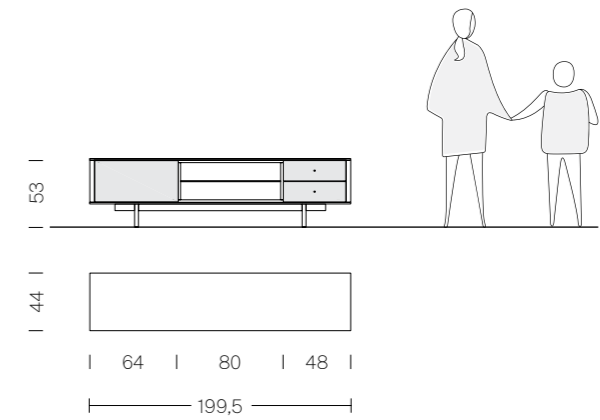



# Moss 05

1072\_P. 154

**ACABADOS**

ESTRUCTURA EXTERIOR 133 caldera mate  
ESTRUCTURA INTERIOR 133 caldera mate  
CAJONES 133 caldera mate, tiradores metal 133 caldera mate

LAN ALFOMBRA crudo

**FINISHES**

OUTER STRUCTURE 133 matt caldera  
INNER STRUCTURE 133 matt caldera  
DRAWERS 133 matt caldera, 133 matt caldera metal handles

LAN CARPET crudo

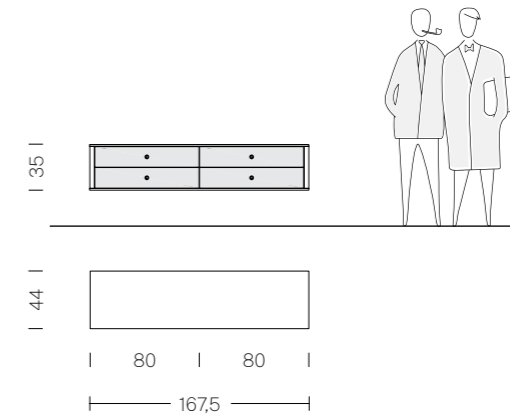



## Moss 06

1982\_P.155

### ACABADOS

ESTRUCTURA EXTERIOR 420 nogal  
ESTRUCTURA INTERIOR 101 arena mate  
PUERTAS MADERA 420 nogal  
CAJONES 106 tórtola mate  
PATAS METÁLICAS metal negro

LAN ALFOMBRA gris

### FINISHES

OUTER STRUCTURE 420 walnut  
INNER STRUCTURE 101 matt arena  
WOOD DOORS 420 walnut  
DRAWERS 106 matt tórtola  
METAL LEGS black metal

LAN CARPET gris

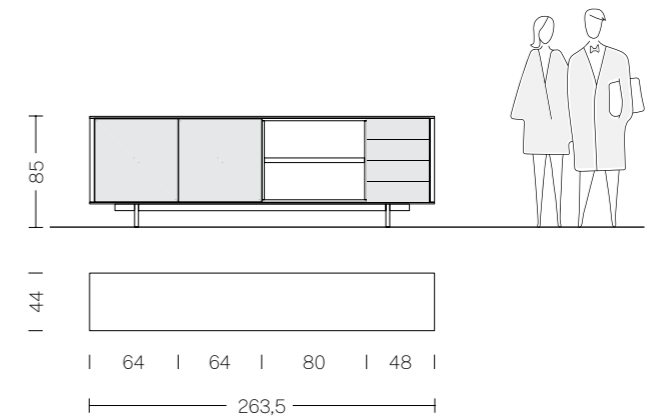



# Moss 07

2410\_P. 156

**ACABADOS**

ESTRUCTURA EXTERIOR 620 eucalipto ahumado  
ESTRUCTURA INTERIOR 100 blanco mate  
PUERTAS CRISTAL BET metal negro, cristal dark grey

LAN ALFOMBRA gris

\*El precio no incluye iluminación led

**FINISHES**

OUTER STRUCTURE 620 smoked eucalyptus  
INNER STRUCTURE 100 matt blanco  
BET GLASS DOORS black metal, glass dark grey

LAN CARPET gris

\*Price does not include led lighting

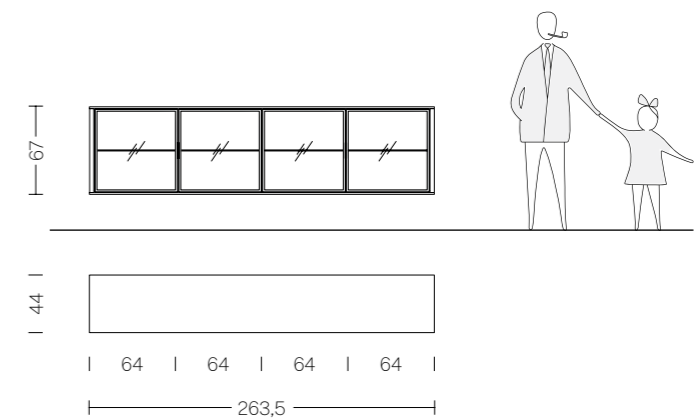



# Moss 08

1786\_P.157

**ACABADOS**

ESTRUCTURA EXTERIOR 420 nogal  
ESTRUCTURA INTERIOR 100 blanco mate  
PUERTAS CRISTAL BET metal negro, cristal transparente  
CAJONES 420 nogal- tiradores metal negro

LAN ALFOMBRA antracita

\*El precio no incluye iluminación led

**FINISHES**

OUTER STRUCTURE 420 walnut  
INNER STRUCTURE 100 matt blanco  
BET GLASS DOORS black metal, transparent glass  
DRAWERS 420 walnut, black metal handles

LAN CARPET antracita

\*Price does not include led lighting

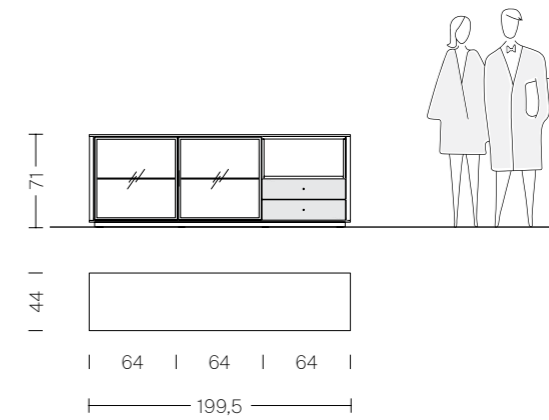



# Moss 09

1532\_P.158

**ACABADOS**

- ESTRUCTURA EXTERIOR 154 plomo mate
- ESTRUCTURA INTERIOR 101 arena mate
- PUERTAS MADERA 154 plomo mate
- PATAS METÁLICAS metal 154 plomo mate

LAN ALFOMBRA crudo

**FINISHES**

- OUTER STRUCTURE 154 matt plomo
- INNER STRUCTURE 101 matt arena
- WOOD DOORS 154 matt plomo
- METAL LEGS 154 matt plomo metal

LAN CARPET crudo

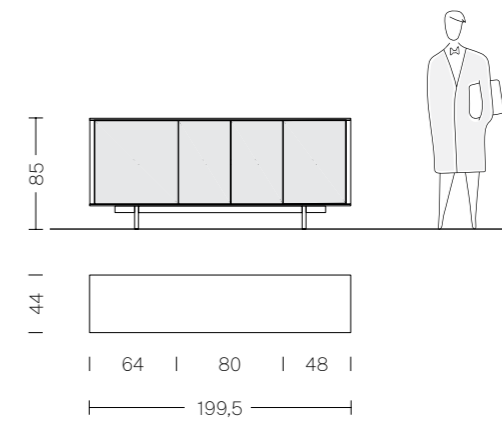





# Moss 10

1242\_P.159

**ACABADOS**

- ESTRUCTURA EXTERIOR 510 roble claro
- ESTRUCTURA INTERIOR 132 camel mate
- PUERTA MADERA 510 roble claro
- CAJONES 112 grafito mate, tirador metal negro
- PATAS METÁLICAS metal negro

LAN ALFOMBRA mostaza

**FINISHES**

- OUTER STRUCTURE 510 oak
- INNER STRUCTURE 132 matt camel
- WOOD DOOR 510 oak
- DRAWERS 112 matt grafito, black metal handleless
- METAL LEGS black metal

LAN CARPET mostaza

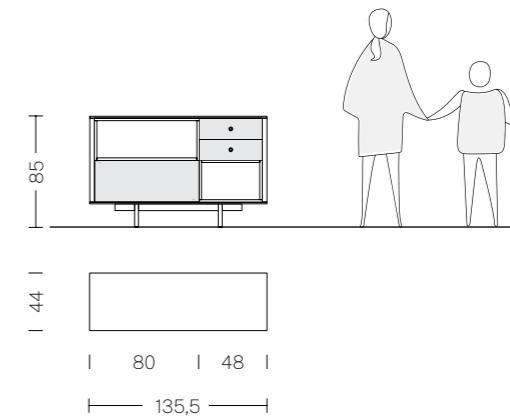



# Moss 11

2248\_P.160

**ACABADOS**  
 ESTRUCTURA EXTERIOR 141 oliva mate  
 ESTRUCTURA INTERIOR 114 gris mate  
 PUERTAS CRISTAL metal negro, cristal transparente  
 PUERTA MADERA 520 roble ceniza

LAN ALFOMBRA crudo

\*El precio no incluye iluminación led

**FINISHES**  
 OUTER STRUCTURE 141 matt oliva  
 INNER STRUCTURE 114 matt gris  
 GLASS DOORS black metal, transparent glass  
 WOOD DOOR 520 oak

LAN CARPET crudo

\*Price does not include led lighting

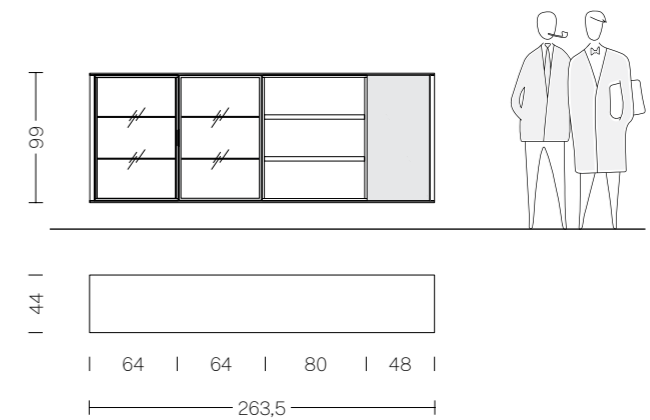



# Moss 12

1658\_P.161

**ACABADOS**

- ESTRUCTURA 620 eucalipto ahumado
- ESTRUCTURA INTERIOR 133 caldera mate
- CAJONES 620 eucalipto ahumado, tiradores metal negro
- PUERTAS MADERA 620 eucalipto ahumado
- PATAS METÁLICAS metal negro

LAN ALFOMBRA antracita

**FINISHES**

- STRUCTURE 620 smoked eucalyptus
- INNER STRUCTURE 133 matt caldera
- DRAWERS 620 smoked eucalyptus, black metal handles
- WOOD DOORS 620 smoked eucalyptus
- METAL LEGS black metal

LAN CARPET antracita

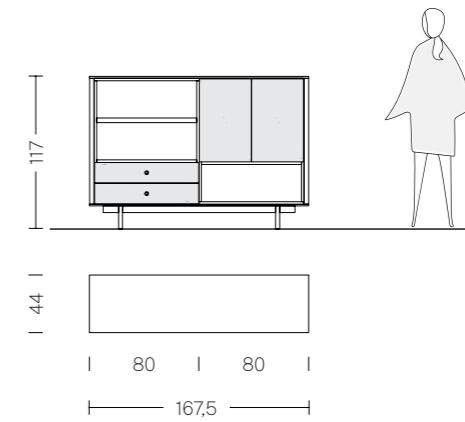



# Moss 13

1438\_P. 162

**ACABADOS**  
 ESTRUCTURA EXTERIOR 153 tinta mate  
 ESTRUCTURA INTERIOR 100 blanco mate  
 PUERTAS CRISTAL BET metal negro, cristal transparente

LAN ALFOMBRA marino

\*El precio no incluye iluminación led

**FINISHES**  
 OUTER STRUCTURE 153 matt tinta  
 INNER STRUCTURE 100 matt blanco  
 BET GLASS DOORS black metal, transparent glass

LAN CARPET marino

\*Price does not include led lighting

1222\_P. 162

**ACABADOS**  
 ESTRUCTURA EXTERIOR 153 tinta mate  
 ESTRUCTURA INTERIOR 100 blanco mate  
 CAJONES 153 tinta mate, tiradores metal negro  
 PUERTA MADERA 153 tinta mate

**FINISHES**  
 OUTER STRUCTURE 153 matt tinta  
 INNER STRUCTURE 100 matt blanco  
 DRAWERS 153 matt tinta, black metal handles  
 WOOD DOOR 153 matt tinta

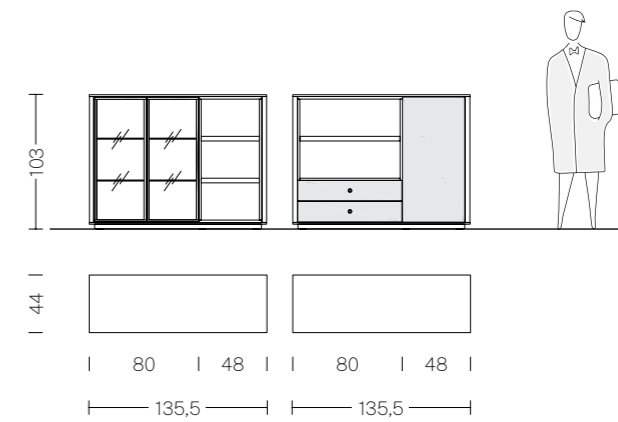

# Moss 14

4096\_P.163

**ACABADOS**

ESTRUCTURA EXTERIOR 123 grana mate  
ESTRUCTURA INTERIOR 100 blanco mate  
PUERTAS CRISTAL BET metal negro, cristal transparente

LAN ALFOMBRA antracita

\*El precio no incluye iluminación led

**FINISHES**

OUTER STRUCTURE 123 matt grana  
INNER STRUCTURE 100 matt blanco  
BET GLASS DOORS black metal, transparent glass

LAN CARPET antracita

\*Price does not include led lighting

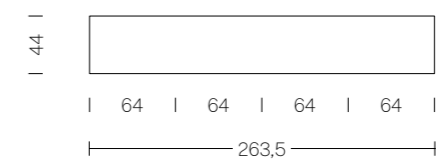
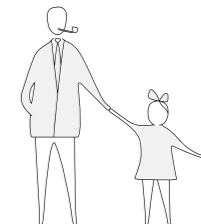
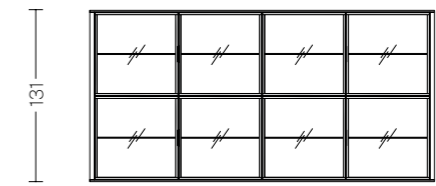
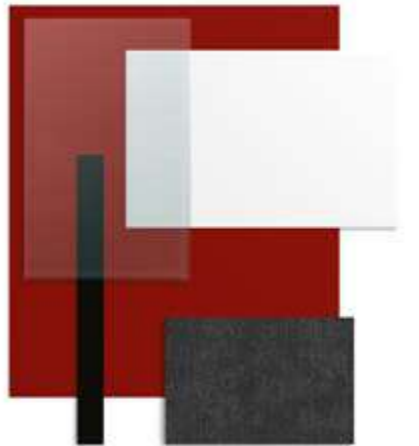



# Moss 15

1976\_P.164

**ACABADOS**

ESTRUCTURA EXTERIOR 620 eucalipto ahumado  
ESTRUCTURA INTERIOR 101 arena mate  
CAJONES 124 terra mate, tiradores metal negro

LAN ALFOMBRA antracita

**FINISHES**

OUTER STRUCTURE 620 smoked eucalyptus  
INNER STRUCTURE 101 matt arena  
DRAWERS 124 matt terra, black metal handles

LAN CARPET antracita

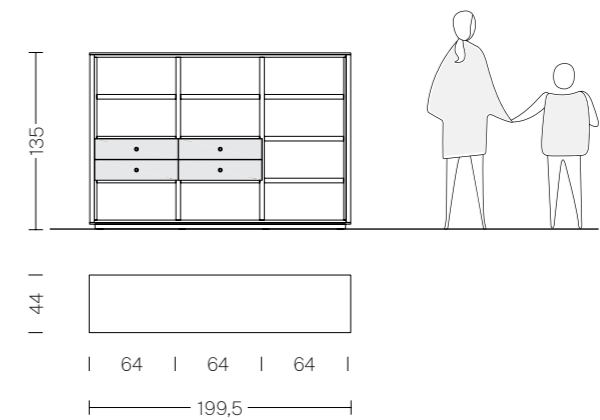



# Moss 16

1580\_P.165

**ACABADOS**

- ESTRUCTURA EXTERIOR 530 roble humo
- ESTRUCTURA INTERIOR 101 arena mate
- PUERTAS MADERA 530 roble humo
- CAJONES 106 tórtola mate, tiradores metal negro

LAN ALFOMBRA lila

**FINISHES**

- OUTER STRUCTURE 530 oak
- INNER STRUCTURE 101 matt arena
- WOOD DOORS 530 oak
- DRAWERS 106 matt tórtola, black metal handles

LAN CARPET lila

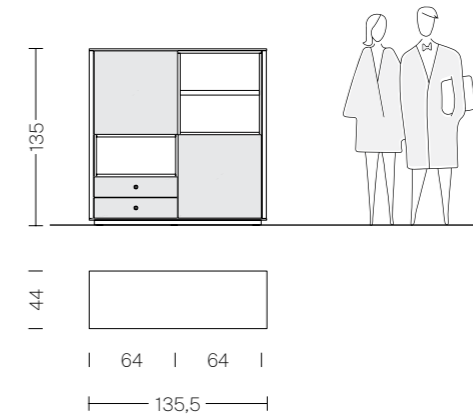

# Yoko

librerías  
bookcase





# Yoko 01

6736\_P.166

**ACABADOS**

- ESTRUCTURAS 101 arena mate
- SEPARADORES 101 arena mate
- CONTENEDORES CERRADOS 520 roble ceniza, 112 grafito mate
- CONTENEDORES ABIERTOS 112 grafito mate
- ESTANTE ESCRITORIO 112 grafito mate

LAN ALFOMBRA antracita

**FINISHES**

- STRUCTURES 101 matt arena
- DIVIDERS 101 matt arena
- CLOSED CONTAINERS 520 oak, 112 matt grafito
- OPEN CONTAINERS 112 matt grafito
- DESK SHELF 112 matt grafito

LAN CARPET antracita

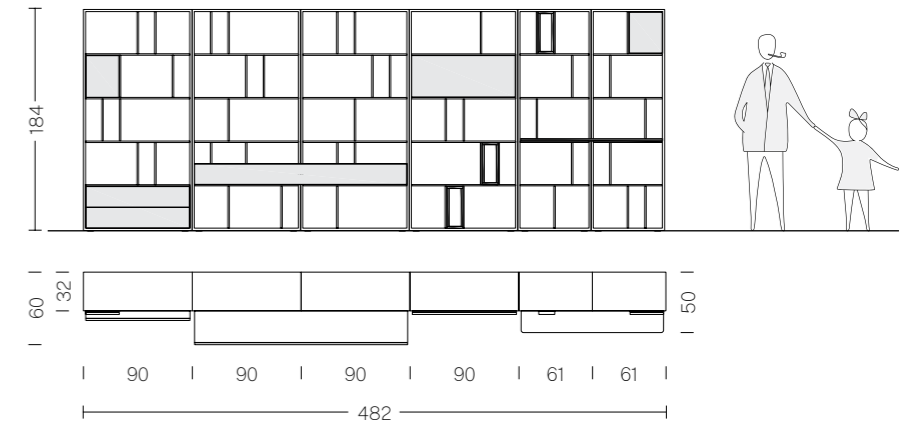

# Yoko 02

6648\_P.167

**ACABADOS**

- ESTRUCTURAS 106 tórtola mate
- SEPARADORES 106 tórtola mate
- CONTENEDORES CERRADOS 530 roble humo
- CONTENEDORES ABIERTOS 153 tinta mate
- CONTENEDORES CRISTAL cristal transparente

LAN ALFOMBRA antracita

**FINISHES**

- STRUCTURES 106 matt tortola
- DIVIDERS 106 matt tortola
- CLOSED CONTAINERS 530 oak
- OPEN CONTAINERS 153 matt tinta
- GLASS CONTAINERS transparent glass

LAN CARPET antracita

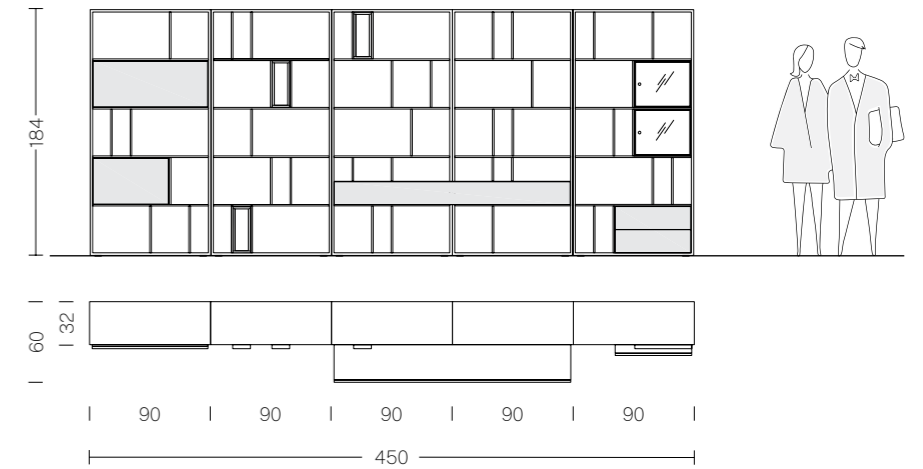

# Yoko 03

5912\_P.168

**ACABADOS**

- ESTRUCTURAS 114 gris mate
- SEPARADORES 114 gris mate
- CONTENEDORES CERRADOS 620 eucalipto ahumado
- CONTENEDORES ABIERTOS 141 oliva mate
- ESTANTE ESCRITORIO 114 gris mate

LAN ALFOMBRA crudo

**FINISHES**

- STRUCTURES 114 matt gris
- DIVIDERS 114 matt gris
- CLOSED CONTAINERS 620 smoked eucalyptus
- OPEN CONTAINERS 141 matt oliva
- DESK SHELF 114 matt gris

LAN CARPET crudo

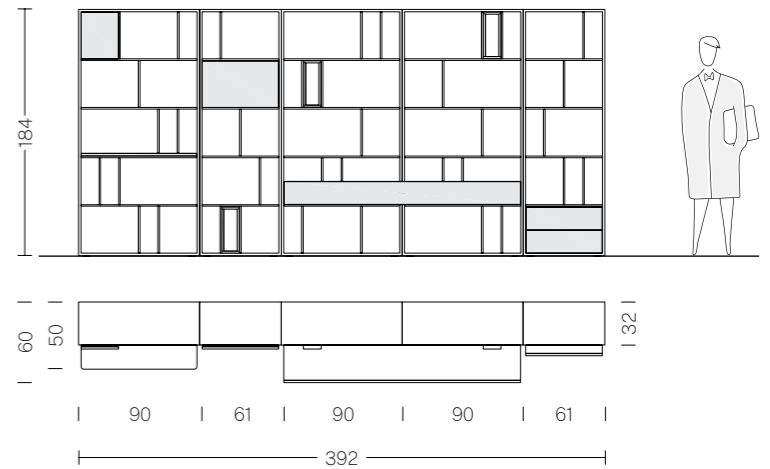

# Yoko 04

5700\_P.169

**ACABADOS**

- ESTRUCTURAS 101 arena mate
- SEPARADORES 101 arena mate
- CONTENEDORES CERRADOS 420 nogal
- CONTENEDORES ABIERTOS 113 antracita mate
- CONTENEDORES CRISTAL cristal transparente

LAN ALFOMBRA antracita

**FINISHES**

- STRUCTURES 101 matt arena
- DIVIDERS 101 matt arena
- CLOSED CONTAINERS 420 walnut
- OPEN CONTAINERS 113 matt antracita
- GLASS CONTAINERS transparent glass

LAN CARPET antracita

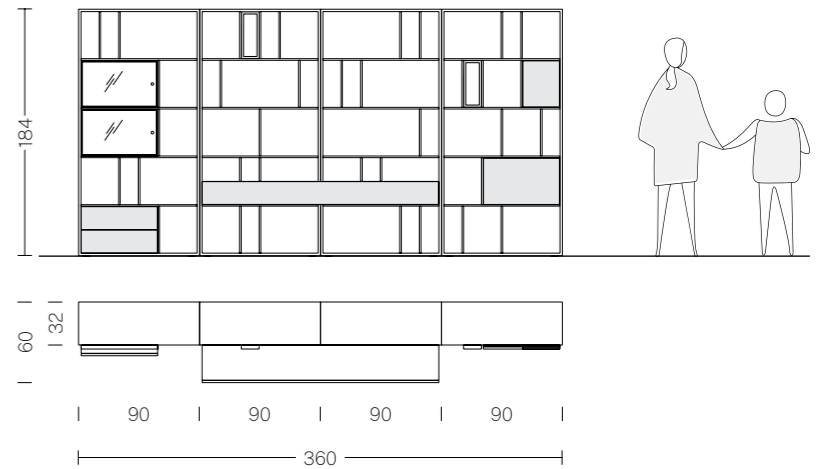

# Yoko 05

4606\_P.170

**ACABADOS**

- ESTRUCTURAS 106 tórtola mate
- SEPARADORES 106 tórtola mate
- CONTENEDORES CERRADOS 520 roble ceniza, 122 polvo mate
- CONTENEDORES ABIERTOS 122 polvo mate
- ESTANTE ESCRITORIO 520 roble ceniza

LAN ALFOMBRA crudo

**FINISHES**

- STRUCTURES 106 matt tortola
- DIVIDERS 106 matt tortola
- CLOSED CONTAINERS 520 oak, 122 matt polvo
- OPEN CONTAINERS 122 matt polvo
- DESK SHELF 520 oak

LAN CARPET crudo

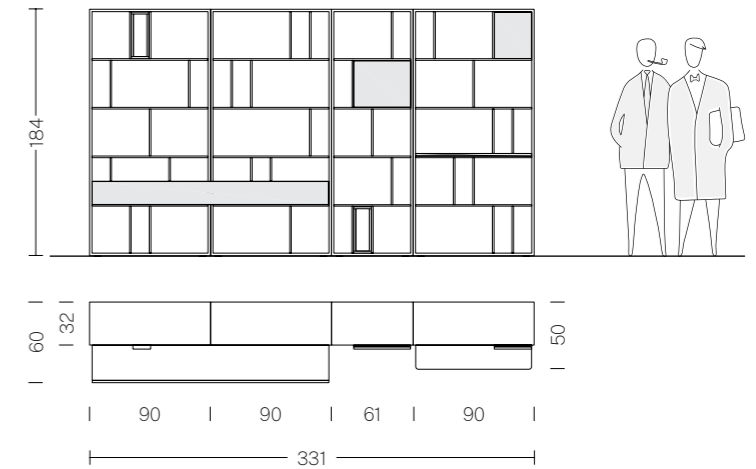

# Yoko 06

4678\_P.171

**ACABADOS**

ESTRUCTURAS 100 blanco mate  
SEPARADORES 100 blanco mate  
CONTENEDORES CERRADOS 510 roble claro, 124 terra mate

LAN ALFOMBRA antracita

**FINISHES**

STRUCTURES 100 matt blanco  
DIVIDERS 100 matt blanco  
CLOSED CONTAINERS 510 oak, 124 matt terra

LAN CARPET antracita

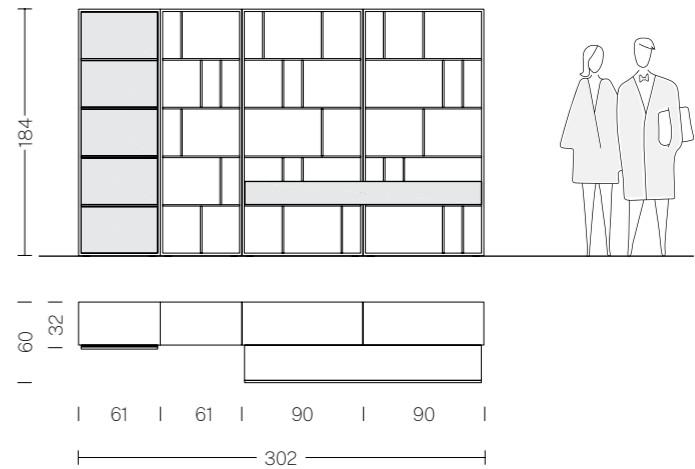

# Yoko 07

3548\_P.172

**ACABADOS**

- ESTRUCTURAS 106 tórtola mate
- SEPARADORES 106 tórtola mate
- CONTENEDORES CERRADOS 530 roble humo
- CONTENEDORES ABIERTOS 133 caldera mate
- CONTENEDOR CRISTAL cristal transparente
- ESTANTE ESCRITORIO 113 antracita mate

LAN ALFOMBRA antracita

**FINISHES**

- STRUCTURES 106 matt tortola
- DIVIDERS 106 matt tortola
- CLOSED CONTAINERS 530 oak
- OPEN CONTAINERS 133 matt caldera
- GLASS CONTAINER transparent glass
- DESK SHELF 113 matt antracita

LAN CARPET antracita

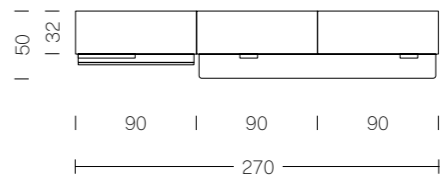
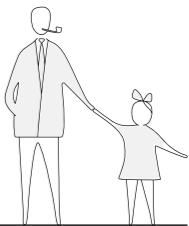
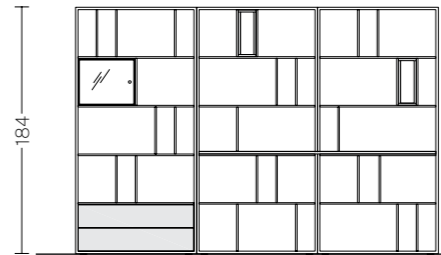

# Yoko 08

2714 / 1250\_P.173

**ACABADOS**

ESTRUCTURAS 114 gris mate  
 SEPARADORES 114 gris mate  
 CONTENEDORES CERRADOS 620 eucalipto ahumado  
 CONTENEDORES ABIERTOS 112 grafito mate

ESTRUCTURAS 114 gris mate  
 SEPARADORES 114 gris mate  
 CONTENEDORES CERRADOS 620 eucalipto ahumado  
 ESTANTE ESCRITORIO 620 eucalipto ahumado

LAN ALFOMBRA grafito

**FINISHES**

STRUCTURES 114 matt gris  
 DIVIDERS 114 matt gris  
 CLOSED CONTAINERS 620 smoked eucalyptus  
 OPEN CONTAINERS 112 matt grafito

STRUCTURES 114 matt gris  
 DIVIDERS 114 matt gris  
 CLOSED CONTAINERS 620 smoked eucalyptus  
 DESK SHELF 620 smoked eucalyptus

LAN CARPET grafito

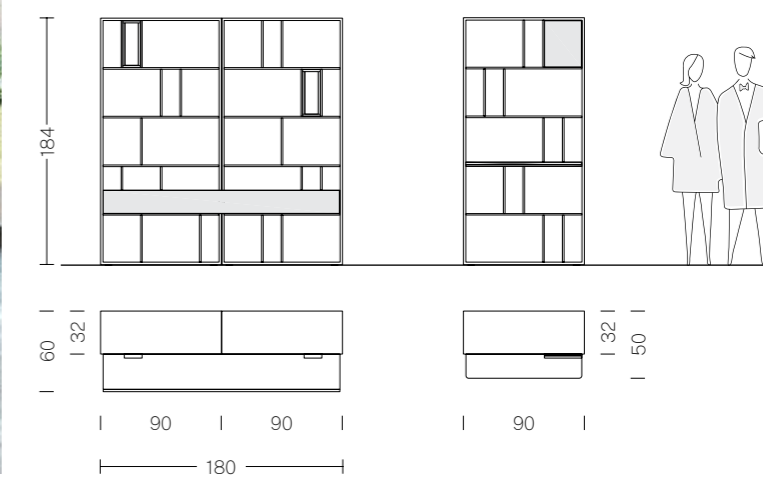





## Yoko 09

1490\_P.174

### ACABADOS

ESTRUCTURAS 106 tórtola mate  
 SEPARADORES 106 tórtola mate  
 CONTENEDORES CERRADOS 530 roble humo, 112 grafito mate  
 CONTENEDOR CRISTAL cristal transparente  
 PATAS METÁLICAS metal negro

LAN ALFOMBRA crudo

### FINISHES

STRUCTURES 106 matt tortola  
 DIVIDERS 106 matt tortola  
 CLOSED CONTAINERS 530 oak, 112 matt grafito  
 GLASS CONTAINER transparent glass  
 METAL LEGS black metal

LAN CARPET crudo

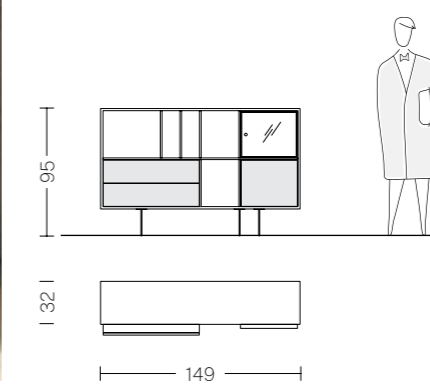



# Yoko 10

1814\_P.175

**ACABADOS**

- ESTRUCTURAS 124 terra mate
- SEPARADORES 124 terra mate
- CONTENEDORES CERRADOS 101 arena mate, 520 roble ceniza
- CONTENEDORES ABIERTOS 101 arena mate

LAN ALFOMBRA gris

**FINISHES**

- STRUCTURES 124 matt terra
- DIVIDERS 124 matt terra
- CLOSED CONTAINERS 101 matt arena, 520 oak
- OPEN CONTAINERS 101 matt arena

LAN CARPET gris

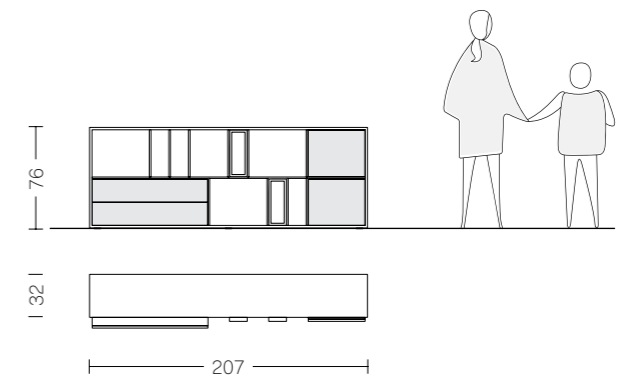



# Yoko 11

1392\_P.176

## ACABADOS

- ESTRUCTURAS 101 arena mate
- SEPARADORES 101 arena mate
- CONTENEDORES CERRADOS 620 eucalipto ahumado
- CONTENEDORES ABIERTOS 123 grana mate
- CONTENEDOR CRISTAL cristal transparente
- PATAS METÁLICAS metal negro

LAN ALFOMBRA antracita

## FINISHES

- STRUCTURES 101 matt arena
- DIVIDERS 101 matt arena
- CLOSED CONTAINERS 620 smoked eucalyptus
- OPEN CONTAINERS 123 matt grana
- GLASS CONTAINER transparent glass
- METAL LEGS black metal

LAN CARPET antracita

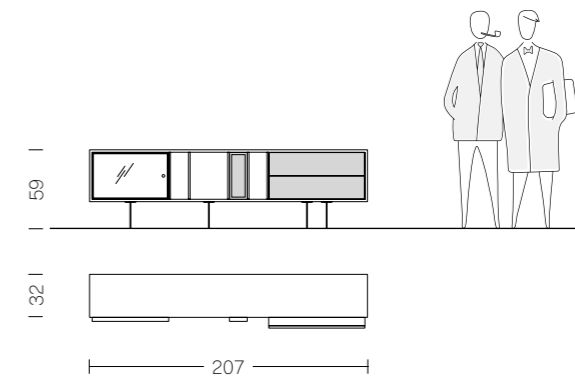



# Yoko 12

868 / 884\_P.177

**ACABADOS**

ESTRUCTURAS 133 caldera mate  
SEPARADORES 133 caldera mate  
CONTENEDORES CERRADOS 510 roble claro, 113 antracita mate

ESTRUCTURAS 133 caldera mate  
SEPARADORES 133 caldera mate  
CONTENEDORES CERRADOS 510 roble claro  
CONTENEDORES ABIERTOS 113 antracita mate

LAN ALFOMBRA antracita

**FINISHES**

STRUCTURES 133 matt caldera  
DIVIDERS 133 matt caldera  
CLOSED CONTAINERS 510 oak, 113 matt antracita

STRUCTURES 133 matt caldera  
DIVIDERS 133 matt caldera  
CLOSED CONTAINERS 510 oak  
OPEN CONTAINERS 113 matt antracita

LAN CARPET antracita

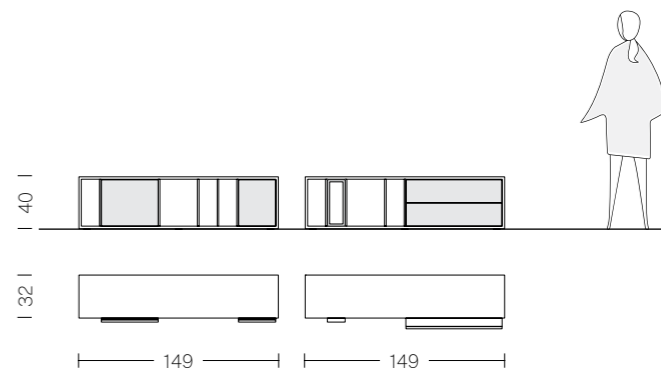

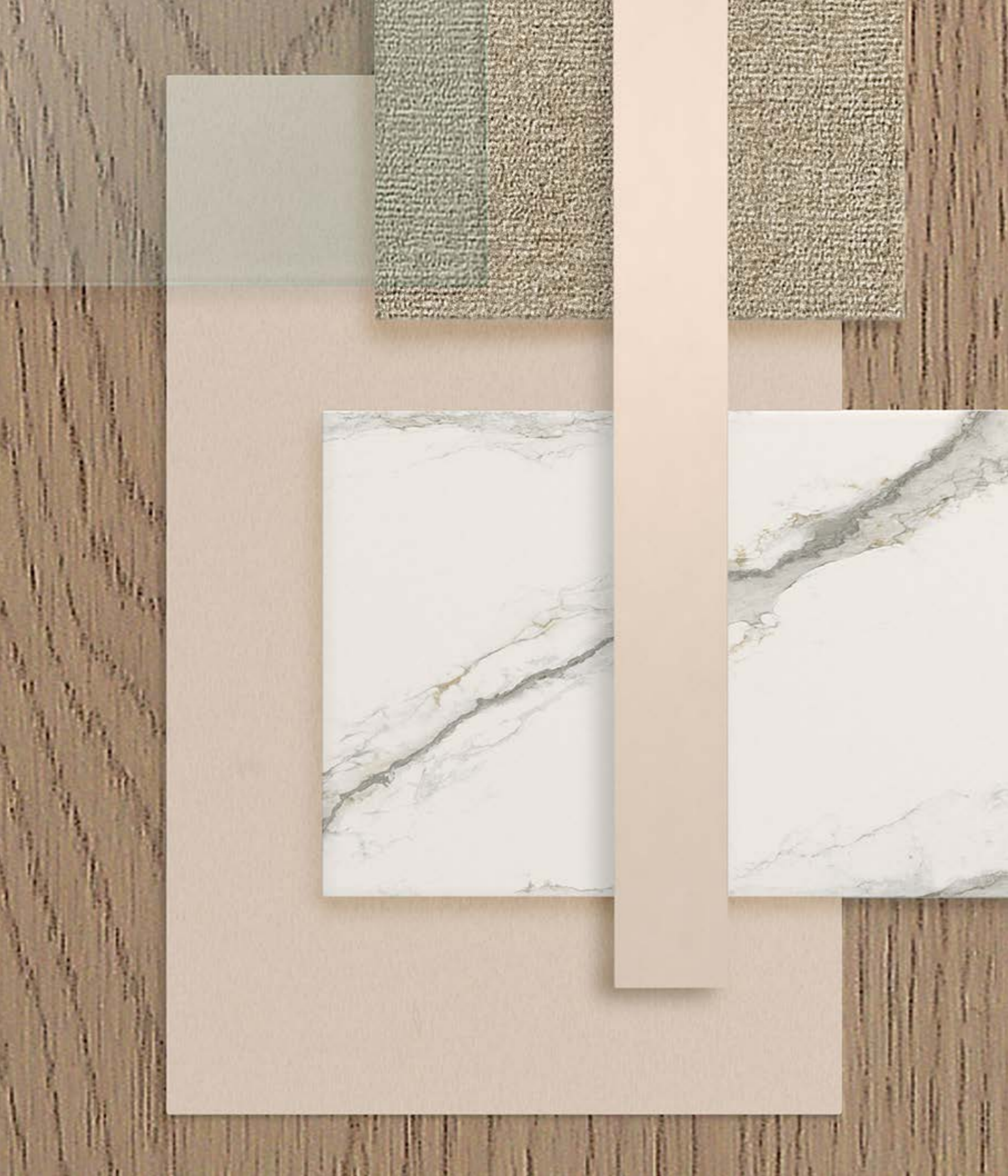

# Q

contenedores a pared  
wall containers



# Q + Brich 01

1806+980\_P.178

**ACABADOS**

- Q2 80x35x35 620 eucalipto ahumado
- Q1 35x35x30 113 antracita mate (2u)
- Q1 35x35x35 112 grafito mate
- Q2 60x35x35 620 eucalipto ahumado
- Q2 35x70x30 420 nogal
- Q1 60x35x35 112 grafito mate

**BRICH** 280x45 H35

- PATAS METÁLICAS metal negro
- ESTRUCTURA 620 eucalipto ahumado
- TAPA porcelánico duomo

LAN ALFOMBRA antracita

**FINISHES**

- Q2 80x35x35 620 smoked eucalyptus
- Q1 35x35x30 113 matt antracita (2u)
- Q1 35x35x35 112 matt grafito
- Q2 60x35x35 620 smoked eucalyptus
- Q2 35x70x30 420 walnut
- Q1 60x35x35 112 matt grafito

**BRICH** 280x45 H35

- METAL LEGS black metal
- STRUCTURE 620 smoked eucalyptus
- TOP COVER duomo porcelain

LAN CARPET antracita

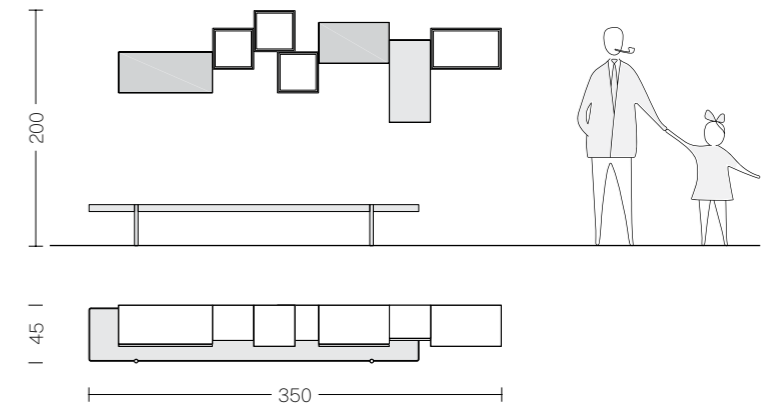



# Q + los 02

1036+2446\_P.179

**ACABADOS**

- Q2 50x40x30 124 terra mate
- Q2 50x45x35 124 terra mate
- Q1 40x50x40 124 terra mate
- Q1 60x35x30 124 terra mate
- Q2 50x35x35 124 terra mate

**IOS L401,5 H41 F42**

- ESTRUCTURA 530 roble humo
- ENCIMERA 112 grafito mate
- PUERTAS MADERA PLAY 106 tórtola mate
- CAJONES IN 101 arena mate, tirador metal negro

**LAN ALFOMBRA** crudo

**FINISHES**

- Q2 50x40x30 124 matt terra
- Q2 50x45x35 124 matt terra
- Q1 40x50x40 124 matt terra
- Q1 60x35x30 124 matt terra
- Q2 50x35x35 124 matt terra

**IOS W401,5 H41 D42**

- STRUCTURE 530 oak
- TOP COVER 112 matt grafito
- PLAY WOOD DOORS 106 matt tórtola
- IN DRAWERS 101 matt arena, black metal handle

**LAN CARPET** crudo

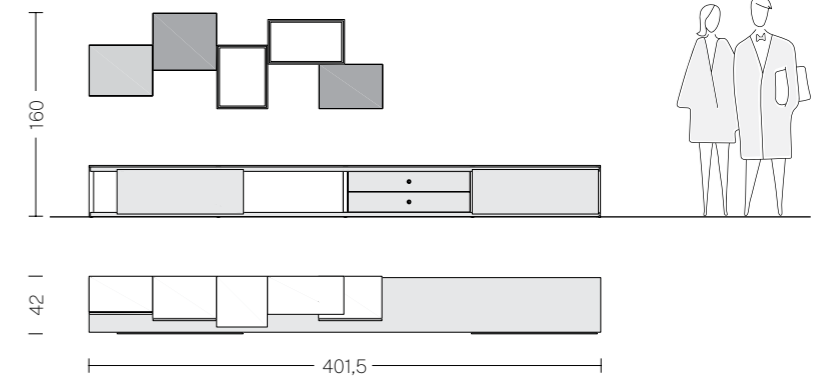



# Q + Brich 03

2172+980\_P.180

**ACABADOS**

- Q3 50x35x35 (3u)
- ESTRUCTURA 101 arena mate
- FRENTE metal negro cristal transparente
- Q1 100x30x40 113 antracita mate
- Q3 50x35x35 (3u)
- ESTRUCTURA 101 arena mate
- FRENTE 101 arena mate

**BRICH 280x45 H35**

- PATAS METÁLICAS metal negro
- ESTRUCTURA 520 roble ceniza
- TAPA porcelánico duomo

LAN ALFOMBRA crudo

**FINISHES**

- Q3 50x35x35 (3u)
- STRUCTURE 101 matt arena
- FRONT black metal transparent glass
- Q1 100x30x40 113 matt antracita
- Q3 50x35x35 (3u)
- STRUCTURE 101 matt arena
- FRONT 101 matt arena

**BRICH 280x45 H35**

- METAL LEGS black metal
- STRUCTURE 520 oak
- TOP COVER duomo porcelain

LAN CARPET crudo

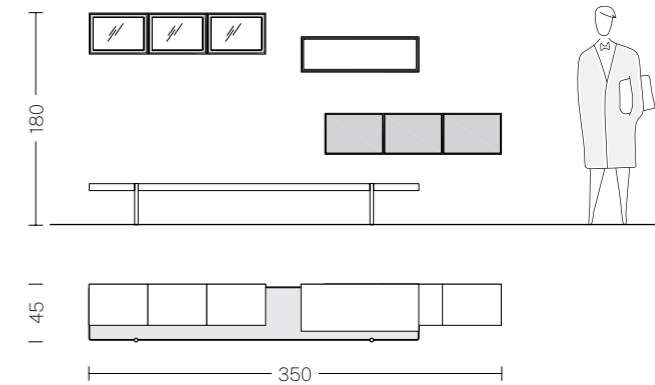





## Q + Moss 04

1194+1612\_P.181

### ACABADOS

Q2 40x35x35 154 plomo mate (4 u)  
Q1 120x30x30 420 nogal

### MOSS L263,5 H35 F44

ESTRUCTURA EXTERIOR 620 eucalipto ahumado  
ESTRUCTURA INTERIOR 114 gris mate  
ESTANTE 114 gris mate  
CAJONES 620 eucalipto ahumado, tirador metal negro  
PUERTA MADERA 620 eucalipto ahumado  
PUERTA CRISTAL BET metal negro, cristal dark grey

LAN ALFOMBRA gris

### FINISHES

Q2 40x35x35 154 matt plomo (4 u)  
Q1 120x30x30 420 walnut

### MOSS W263,5 H35 D44

OUTER STRUCTURE 620 smoked eucalyptus  
INNER STRUCTURE 114 matt gris  
SHELF 114 matt gris  
DRAWERS 620 smoked eucalyptus, black metal handle  
WOOD DOOR 620 smoked eucalyptus  
BET GLASS DOOR black metal, dark grey glass

LAN CARPET gris

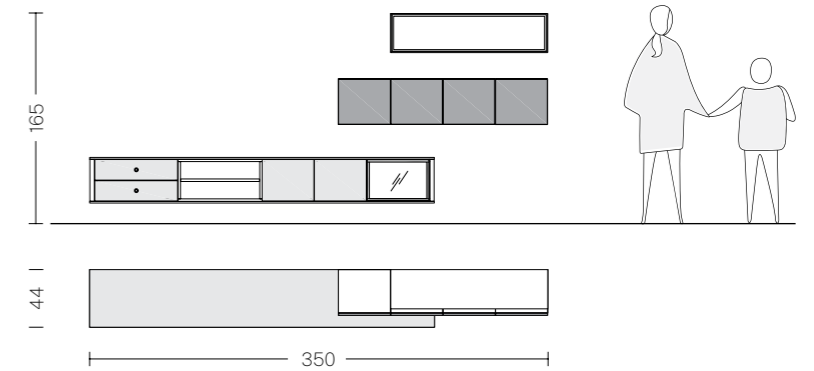



## Q + Brich 05

2904+980\_P.182

### ACABADOS

Q3 30x80x30  
 ESTRUCTURA 520 roble ceniza  
 FRENTE metal 101 arena mate, cristal transparente  
 Q3 30x40x30 (3u)  
 ESTRUCTURA 520 roble ceniza  
 FRENTE 101 arena mate  
 Q3 30x60x35  
 ESTRUCTURA 520 roble ceniza  
 FRENTE 101 arena mate  
 Q3 30x80x35  
 ESTRUCTURA 520 roble ceniza  
 FRENTE metal 101 arena mate, cristal transparente  
 Q3 30x40x35  
 ESTRUCTURA 520 roble ceniza  
 FRENTE 101 arena mate  
 Q3 30x60x30  
 ESTRUCTURA 520 roble ceniza  
 FRENTE 101 arena mate

BRICH 280x45 H35  
 PATAS METÁLICAS metal negro  
 ESTRUCTURA 520 roble ceniza  
 TAPA porcelánico duomo

LAN ALFOMBRA gris

### FINISHES

Q3 30x80x30  
 STRUCTURE 520 oak  
 FRONT 101 matt arena metal, transparent glass  
 Q3 30x40x30 (3u)  
 STRUCTURE 520 oak  
 FRONT 101 matt arena  
 Q3 30x60x35  
 STRUCTURE 520 oak  
 FRONT 101 matt arena  
 Q3 30x80x35  
 STRUCTURE 520 oak  
 FRONT 101 matt arena metal, transparent glass  
 Q3 30x40x35  
 STRUCTURE 520 oak  
 FRONT 101 matt arena  
 Q3 30x60x30  
 STRUCTURE 520 oak  
 FRONT 101 matt arena

BRICH 280x45 H35  
 METAL LEGS black metal  
 STRUCTURE 520 oak  
 TOP COVER duomo porcelain

LAN CARPET gris

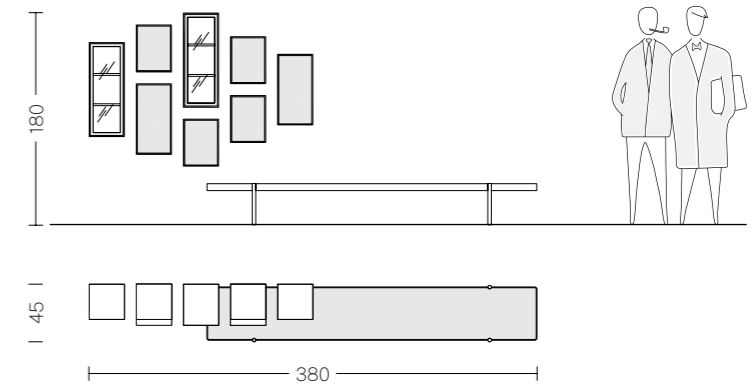
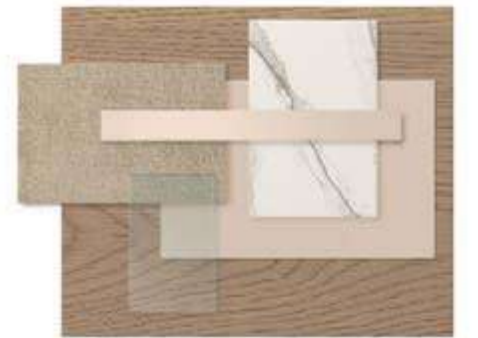



# Q + Moss 06

2152+1114\_P.183

**ACABADOS**  
 Q3 35x90x35 (4u)  
 ESTRUCTURA 122 polvo mate  
 FRENTE metal negro cristal transparente

**MOSS L231,5 H39 F44**  
 ESTRUCTURA EXTERIOR 510 roble claro  
 ESTRUCTURA INTERIOR 101 arena mate  
 PUERTAS MADERA 510 roble claro

LAN ALFOMBRA gris

**FINISHES**  
 Q3 35x90x35 (4u)  
 STRUCTURE 122 matt polvo  
 FRONT black metal transparent glass

**MOSS W231,5 H39 D44**  
 OUTER STRUCTURE 510 oak  
 INNER STRUCTURE 101 matt arena  
 WOOD DOORS 510 oak

LAN CARPET gris

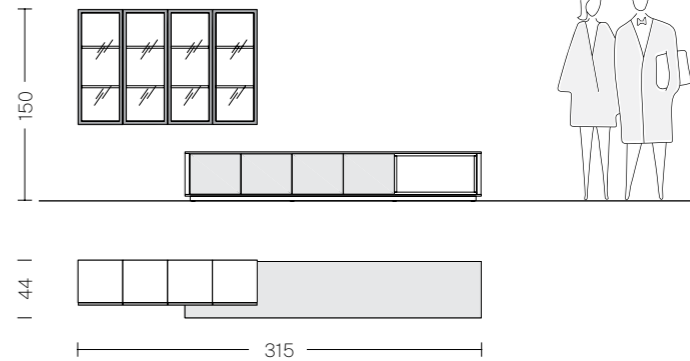



## Q + Yoko 07

1704+1958\_P.184

**ACABADOS**

Q3 110x30x30 (3u)  
 ESTRUCTURA 520 roble ceniza  
 FRENTE metal 101 arena mate

YOKO L178 H40 F41 (2u)  
 ESTRUCTURA 101 arena mate  
 SEPARADORES 101 arena mate  
 CONTENEDORES CERRADOS 520 roble ceniza  
 CONTENEDOR CRISTAL cristal transparente

ESTRUCTURA 101 arena mate  
 SEPARADORES 101 arena mate  
 CONTENEDORES CERRADOS 133 caldera mate, 520 roble ceniza

LAN ALFOMBRA crudo

**FINISHES**

Q3 110x30x30 (3u)  
 STRUCTURE 520 oak  
 FRONT 101 matt arena metal

YOKO W178 H40 D41 (2u)  
 STRUCTURE 101 matt arena  
 DIVIDERS 101 matt arena  
 CLOSED CONTAINERS 520 oak  
 GLASS CONTAINER transparent glass

STRUCTURE 101 matt arena  
 DIVIDERS 101 matt arena  
 CLOSED CONTAINERS 133 matt caldera, 520 oak

LAN CARPET crudo

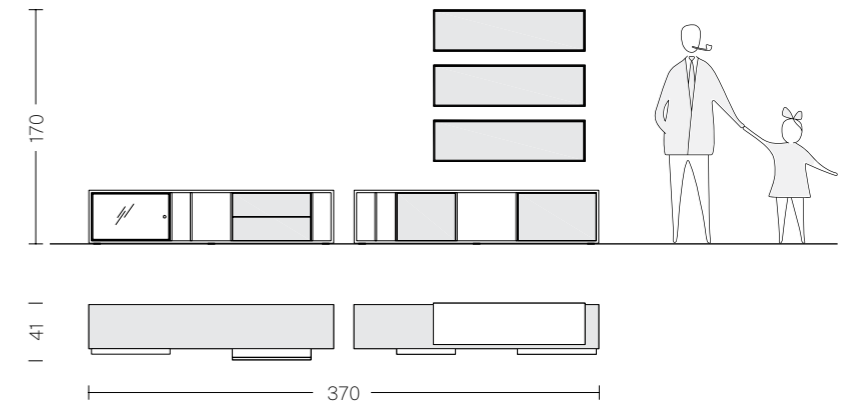



# Q + Brich 08

1418+880\_P.185

**ACABADOS**

Q2 120x30x30 106 tórtola mate (2u)  
Q3 110x35x40  
ESTRUCTURA 510 roble claro  
FRENTE 106 tórtola mate

**BRICH 230x45 H35**

PATAS METÁLICAS metal negro  
ESTRUCTURA 510 roble claro  
TAPA porcelánico paladio

LAN ALFOMBRA antracita

**FINISHES**

Q2 120x30x30 106 matt tórtola (2u)  
Q3 110x35x40  
STRUCTURE 510 oak  
FRONT 106 matt tórtola

**BRICH 230x45 H35**

METAL LEGS black metal  
STRUCTURE 510 oak  
TOP COVER paladio porcelain

LAN CARPET antracita

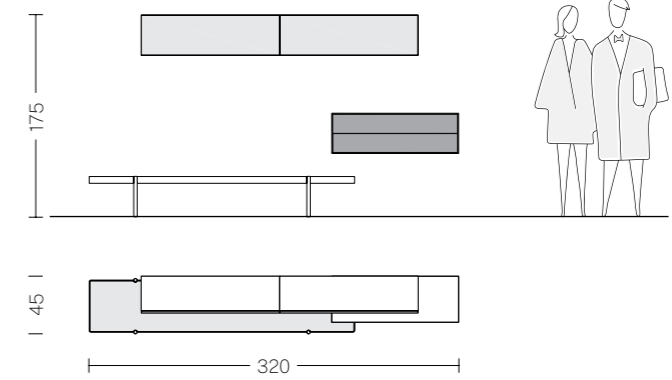



# Q 09

2704\_P.186

### ACABADOS

- Q1 40x40x30 124 terra mate
- Q1 40x40x40 420 nogal
- Q1 40x30x35 620 eucalipto ahumado
- Q1 70x30x30 124 terra mate
- Q1 40x40x30 114 gris mate
- Q1 30x50x35 112 grafito mate
- Q1 40x40x40 420 nogal
- Q1 70x30x30 150 lavanda mate
- Q1 40x30x35 620 eucalipto ahumado
- Q1 70x30x30 150 lavanda mate
- Q1 40x30x35 620 eucalipto ahumado
- Q1 40x40x40 420 nogal
- Q1 30x50x35 114 gris mate

LAN ALFOMBRA gris

### FINISHES

- Q1 40x40x30 124 matt terra
- Q1 40x40x40 420 walnut
- Q1 40x30x35 620 smoked eucalyptus
- Q1 70x30x30 124 matt terra
- Q1 40x40x30 114 matt gris
- Q1 30x50x35 112 matt graphite
- Q1 40x40x40 420 walnut
- Q1 70x30x30 150 matt lavanda
- Q1 40x30x35 620 smoked eucalyptus
- Q1 70x30x30 150 matt lavanda
- Q1 40x30x35 620 smoked eucalyptus
- Q1 40x40x40 420 walnut
- Q1 30x50x35 114 matt gris

LAN CARPET gris

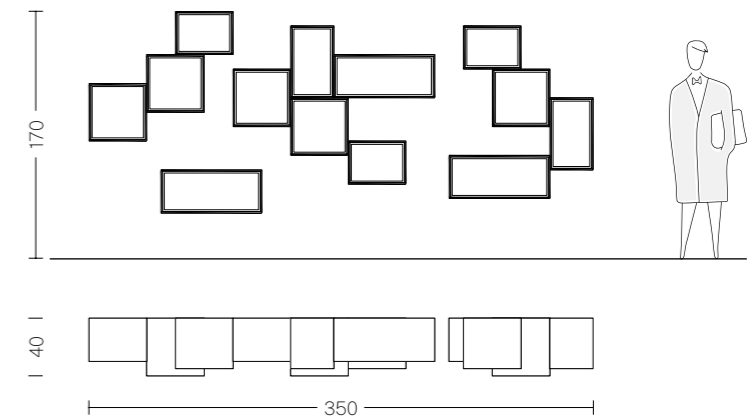



# Q 10

1824\_P.187

**ACABADOS**

- Q1 80x30x30 101 arena mate
- Q1 60x30x35 153 tinta mate
- Q1 30x60x35 106 tórtola mate
- Q2 45x45x30 520 roble ceniza (2u)
- Q2 80x35x40 101 arena mate, tirador metal negro
- Q2 45x35x30 520 roble ceniza

LAN ALFOMBRA crudo

**FINISHES**

- Q1 80x30x30 101 matt arena
- Q1 60x30x35 153 matt tinta
- Q1 30x60x35 106 matt tórtola
- Q2 45x45x30 520 oak (2u)
- Q2 80x35x40 101 matt arena, black metal handle
- Q2 45x35x30 520 oak

LAN CARPET crudo

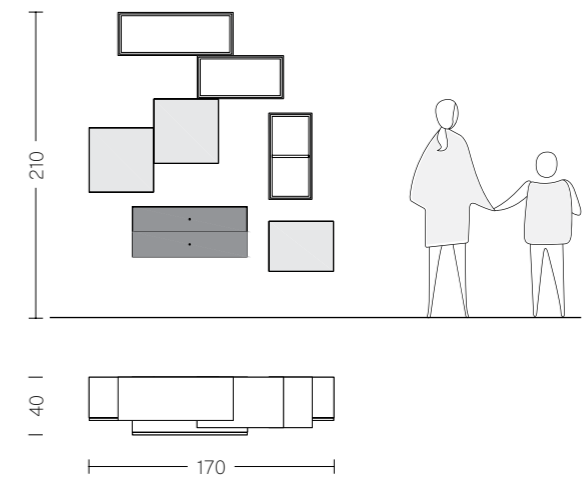



# Q 11

2190\_P.188

**ACABADOS**

- Q1 30x30x30 123 grana mate (3u)
- Q2 40x40x35 106 tórtola mate, metal negro, cristal transparente (2u)
- Q2 80x30x35 510 roble claro
- Q2 50x35x40 510 roble claro (2u)

LAN ALFOMBRA antracita

**FINISHES**

- Q1 30x30x30 123 matt grana (3u)
- Q2 40x40x35 106 matt tórtola, black metal, transparent glass (2u)
- Q2 80x30x35 510 oak
- Q2 50x35x40 510 oak (2u)

LAN CARPET antracita

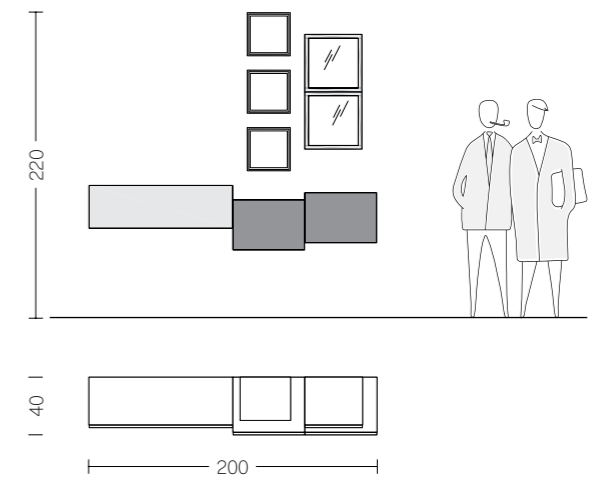





## Q 12

1326\_P. 189

### ACABADOS

- Q1 40x30x30 520 roble ceniza
- Q1 40x30x35 530 roble humo
- Q1 60x30x30 520 roble ceniza
- Q2 80x30x40 112 grafito mate, tirador metal negro
- Q1 80x30x35 530 roble humo

LAN ALFOMBRA antracita

### FINISHES

- Q1 40x30x30 520 oak
- Q1 40x30x35 530 oak
- Q1 60x30x30 520 oak
- Q2 80x30x40 112 matt grafito, black metal handle
- Q1 80x30x35 530 oak

LAN CARPET antracita

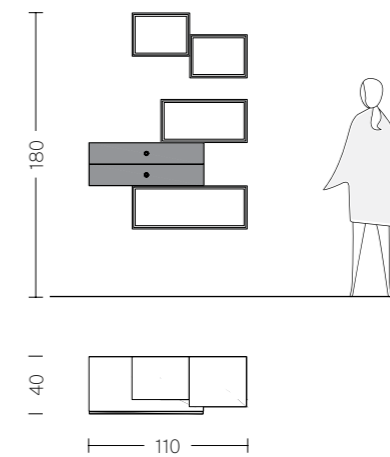



# Q 13

1658\_P.190

**ACABADOS**

- Q3 70x40x30
- ESTRUCTURA 620 eucalipto ahumado
- FRENTE 106 tórtola mate
- Q3 40x65x35
- ESTRUCTURA 620 eucalipto ahumado
- FRENTE metal negro, cristal dark grey
- Q1 50x45x40 124 terra mate
- Q3 60x35x35
- ESTRUCTURA 620 eucalipto ahumado
- FRENTE 106 tórtola mate

LAN ALFOMBRA crudo

**FINISHES**

- Q3 70x40x30
- STRUCTURE 620 smoked eucalyptus
- FRONT 106 matt tortola
- Q3 40x65x35
- STRUCTURE 620 smoked eucalyptus
- FRONT black metal, dark grey glass
- Q1 50x45x40 124 matt terra
- Q3 60x35x35
- STRUCTURE 620 smoked eucalyptus
- FRONT 106 matt tortola

LAN CARPET crudo

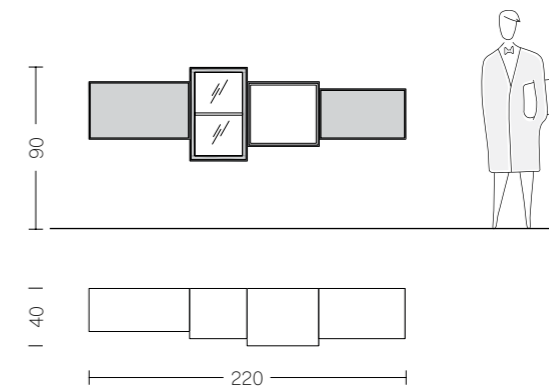

# Q 14

2526\_P.191

**ACABADOS**

Q3 40x85x35  
 ESTRUCTURA 520 roble ceniza  
 FRENTE 101 arena mate  
 Q3 55x50x35  
 ESTRUCTURA 520 roble ceniza  
 FRENTE 101 arena mate  
 Q3 55x35x35  
 ESTRUCTURA 520 roble ceniza  
 FRENTE 101 arena mate

**FINISHES**

Q3 40x85x35  
 STRUCTURE 520 oak  
 FRONT 101 matt arena  
 Q3 55x50x35  
 STRUCTURE 520 oak  
 FRONT 101 matt arena  
 Q3 55x35x35  
 STRUCTURE 520 oak  
 FRONT 101 matt arena

Q3 55x50x35  
 ESTRUCTURA 520 roble ceniza  
 FRENTE 101 arena mate  
 Q3 40x35x35  
 ESTRUCTURA 520 roble ceniza  
 FRENTE 101 arena mate  
 Q3 55x35x35  
 ESTRUCTURA 520 roble ceniza  
 FRENTE 101 arena mate  
 Q3 40x50x35  
 ESTRUCTURA 520 roble ceniza  
 FRENTE 101 arena mate

Q3 55x50x35  
 STRUCTURE 520 oak  
 FRONT 101 matt arena  
 Q3 40x35x35  
 STRUCTURE 520 oak  
 FRONT 101 matt arena  
 Q3 55x35x35  
 STRUCTURE 520 oak  
 FRONT 101 matt arena  
 Q3 40x50x35  
 STRUCTURE 520 oak  
 FRONT 101 matt arena

LAN ALFOMBRA antracita

LAN CARPET antracita

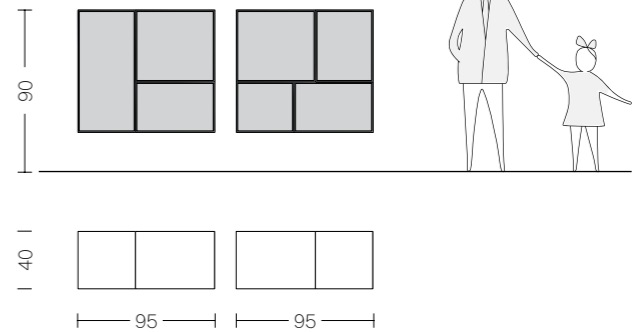

# los 01

ref	descripción/description	acabado/finish	u	p/u	total
<b>ESTRUCTURA/STRUCTURE</b>					
IS_110S172	IOS v a suelo . separador 7h L3,5 H252,5 F42 IOS floor v . divider 7h W3.5 H252.5 D42	laca mate matt lacquer	5	154	770
IS_120M772	IOS v a suelo . m librería 7h L163,5 H252,5 F42 IOS floor v . bookcase module 7h W163.5 H252.5 D42	laca mate matt lacquer	1	980	980
IS_130M772	IOS v a suelo . m tv 7h L163,5 H252,5 F42 IOS floor v . tv module 7h W163.5 H252.5 D42	laca mate matt lacquer	1	792	792
IS_120M572	IOS v a suelo . m librería 7h L96 H252,5 F42 IOS floor v . bookcase module 7h W96 H252.5 D42	laca mate matt lacquer	2	674	1348
IS_420E512	IOS e comunes . estante madera L96 H3,5 F42 IOS common elements . wooden shelf W96 H3,5 D42	laca mate matt lacquer	-8	70	-560
IS_430E512	IOS e comunes . estante cristal L96 F42 IOS common elements . glass shelf W96 H0.6 D42	transparente transparent	8	42	336
<b>COMPLEMENTOS/COMPLEMENTS</b>					
IS_451A111	IOS e comunes . apoyo int forma L32 H32 F28 IOS common elements . free inner divider U W32 H32 D28	laca mate matt lacquer	4	60	240
AC_21	ACCESORIOS . guia corredera PLAY aluminio negro L333,5 ACCESSORIES . PLAY black aluminum sliding guide W333,5	laca mate matt lacquer	2	200	400
IS_710P73	IOS f correderos . PLAY puerta madera 3h L166,5 H106 IOS sliding fronts . PLAY wooden door 3h W166.5 H106	roble oak	1	322	322
IS_672P55	IOS f solapados . AIR jgo puertas cristal bat 5h L99 H177 IOS overlapping fronts . AIR hinged glass doors set 5h W99 H177	metal negro / dark grey black metal / dark grey	2	682	1364
			<b>TOTAL</b>	<b>5992</b>	
<b>ILUMINACION (OPCIONAL) / LIGHTING (OPTION)</b>					
IS_460L5	IOS e comunes . led estante sin interruptor L96 IOS common elements . led shelf without swith W96		2	50	100
AC_52	ACCESORIOS . iluminación control remoto (interruptor sin cable) ACCESSORIES . remote control lighting (cordless switch)		1	68	68
AC_511	ACCESORIOS . iluminación transformador . 30w ACCESSORIES . transformer lighting . 30w		1	64	64

# los 02

ref	descripción/description	acabado/finish	u	p/u	total
<b>ESTRUCTURA/STRUCTURE</b>					
IS_110S162	IOS v a suelo . separador 6h L3,5 H217 F42 IOS floor v . divider 6h W3.5 H217 D42	roble oak	5	180	900
IS_120M762	IOS v a suelo . m librería 6h L163,5 H217 F42 IOS floor v . bookcase module 6h W163.5 H217 D42	laca mate / est. roble matt lacquer / oak shelves	1	856	856
IS_420E712	IOS e comunes . estante madera L163,5 H3,5 F42 IOS common elements . wooden shelf W163,5 H3,5 D42	laca mate matt lacquer	-7	98	-686
IS_420E712	IOS e comunes . estante madera L163,5 H3,5 F42 IOS common elements . wooden shelf W163,5 H3,5 D42	roble oak	7	128	896
IS_130M762	IOS v a suelo . m tv 6h L163,5 H217 F42 IOS floor v . tv module 6h W163.5 H217 D42	laca mate / est. roble matt lacquer / oak shelves	1	668	668
IS_420E712	IOS e comunes . estante madera L163,5 H3,5 F42 IOS common elements . wooden shelf W163,5 H3,5 D42	laca mate matt lacquer	-5	98	-490
IS_420E712	IOS e comunes . estante madera L163,5 H3,5 F42 IOS common elements . wooden shelf W163,5 H3,5 D42	roble oak	5	128	640
IS_120M462	IOS v a suelo . m librería 6h L80 H217 F42 IOS floor v . bookcase module 6h W80 H217 D42	laca mate / est. roble matt lacquer / oak shelves	2	528	1056
IS_420E412	IOS e comunes . estante madera L80 H3,5 F42 IOS common elements . wooden shelf W80 H3,5 D42	laca mate matt lacquer	-14	64	-896
IS_420E412	IOS e comunes . estante madera L80 H3,5 F42 IOS common elements . wooden shelf W80 H3,5 D42	roble oak	14	82	1148
<b>COMPLEMENTOS/COMPLEMENTS</b>					
IS_450A111	IOS e comunes . apoyo int recto L3,5 H32 F28 IOS common elements . free inner divider W3.5 H32 D28	roble oak	2	34	68
AC_21	ACCESORIOS . guia corredera PLAY aluminio negro L502,5 ACCESSORIES . PLAY black aluminum sliding guide W502,5	roble oak	4	302	1208
IS_710P71	IOS f correderos . PLAY puerta madera 1h L166,5 H35 IOS sliding fronts . PLAY wooden door 1h W166.5 H35	laca mate matt lacquer	2	160	320
IS_710P53	IOS f correderos . PLAY puerta madera 3h L99 H106 IOS sliding fronts . PLAY wooden door 3h W99 H106	laca mate matt lacquer	1	202	202
IS_710P73	IOS f correderos . PLAY puerta madera 3h L166,5 H106 IOS sliding fronts . PLAY wooden door 3h W166.5 H106	laca mate matt lacquer	1	270	270
IS_510C412	IOS f interiores . IN jgo 2 cajones 1h L80 H32 F42 sin tirador IOS inner fronts . IN set 2 drawers 1h W80 H32 D42 handleless	laca mate matt lacquer	1	186	186
			<b>TOTAL</b>	<b>6346</b>	

ref	descripción/description	acabado/finish	u	p/u	total
<b>ESTRUCTURA/STRUCTURE</b>					
IS_110S162	IOS v a suelo . separador 6h L3,5 H217 F42 IOS floor v . divider 6h W3.5 H217 D42	nogal walnut	5	180	900
IS_120M562	IOS v a suelo . m librería 6h L96 H217 F42 IOS floor v . bookcase module 6h W96 H217 D42	nogal walnut	2	796	1592
IS_150M762	IOS v a suelo . m escritorio (módulo) 6h L163,5 H217 F42 IOS floor v . desktop module (module) 6h W163.5 H217 D42	nogal walnut	1	950	950
IS_151M712	IOS v a suelo . m escritorio (estante) L163,5 H4,5 F50 IOS floor v . desktop module (desk shelf) W163.5 H4.5 D50	laca mate matt lacquer	1	160	160
IS_120M562	IOS v a suelo . m librería 6h L96 H217 F42 IOS floor v . bookcase module 6h W96 H217 D42	nogal walnut	1	796	796
<b>COMPLEMENTOS/COMPLEMENTS</b>					
IS_620P51	IOS f solapados . STEP puerta madera aba 1h L99 H35 IOS overlapping fronts . STEP bottom hung wooden door 1h W99 H35	laca mate matt lacquer	4	162	648
IS_630P51	IOS f solapados . STEP puerta madera ele 1h L99 H35 IOS overlapping fronts . STEP top hung wooden door 1h W99 H35	laca mate matt lacquer	4	156	624
IS_630P71	IOS f solapados . STEP puerta madera ele 1h L166,5 H35 IOS overlapping fronts . STEP top hung wooden door 1h W166.5 H35	laca mate matt lacquer	1	200	200
IS_610C512_1	IOS f solapados . STEP jgo 2 cajones 1h L99 H35 F42 tirador embutido negro IOS overlapping fronts . STEP set 2 drawers 1h W99 H35 D42 inlay black handle	laca mate matt lacquer	1	246	246
OP_110	OPCIONAL . incremento metal lacado . tirador embutido OPTIONAL . lacquered metal increment . inlay handle	laca mate matt lacquer	2	10	20
			<b>TOTAL</b>	<b>6136</b>	
<b>ILUMINACION (OPCIONAL) / LIGHTING (OPTION)</b>					
IS_461L7	IOS e comunes . led estante con interruptor L163,5 IOS common elements . led shelf with switch W163,5		1	92	92
AC_511	ACCESORIOS . iluminación transformador . 30w ACCESSORIES . transformer lighting . 30w		1	64	64

ref	descripción/description	acabado/finish	u	p/u	total
<b>ESTRUCTURA/STRUCTURE</b>					
IS_110S162	IOS v a suelo . separador 6h L3,5 H217 F42 IOS floor v . divider 6h W3.5 H217 D42	laca mate matt lacquer	5	140	700
IS_120M362	IOS v a suelo . m librería 6h L64 H217 F42 IOS floor v . bookcase module 6h W64 H217 D42	laca mate matt lacquer	4	468	1872
IS_420E312	IOS e comunes . estante madera L64 H3,5 F42 IOS common elements . wooden shelf W64 H3.5 D42	laca mate matt lacquer	-12	58	-696
IS_430E312	IOS e comunes . estante cristal L64 F42 IOS common elements . glass shelf W64 H0.6 D42	transparente transparent	12	34	408
<b>COMPLEMENTOS/COMPLEMENTS</b>					
IS_670P32	IOS f solapados . AIR puerta cristal bat iz 2h L67 H70,5 IOS overlapping fronts . AIR hinged glass door left 2h W67 H70.5	metal negro / transparente black metal/transparent	6	250	1500
OP_111	OPCIONAL . incremento metal lacado . puerta cristal AIR 2h L67 H70,5 OPTIONAL . lacquered metal increment . AIR glass door 2h W67 H70,5	laca mate matt lacquer	6	20	120
IS_671P32	IOS f solapados . AIR puerta cristal bat de 2h L67 H70,5 IOS overlapping fronts . AIR hinged glass door right 2h W67 H70.5	metal negro / transparente black metal/transparent	6	250	1500
OP_111	OPCIONAL . incremento metal lacado . puerta cristal AIR 2h L67 H70,5 OPTIONAL . lacquered metal increment . AIR glass door 2h W67 H70,5	laca mate matt lacquer	6	20	120
			<b>TOTAL</b>	<b>5524</b>	
<b>ILUMINACION (OPCIONAL) / LIGHTING (OPTION)</b>					
IS_460L3	IOS e comunes . led estante sin interruptor L64 IOS common elements . led shelf without swith W64		12	42	504
AC_52	ACCESORIOS . iluminación control remoto (interruptor sin cable) ACCESSORIES . remote control lighting (cordless switch)		2	68	136
AC_512	ACCESORIOS . iluminación transformador . 75w ACCESSORIES . transformer lighting . 75w		2	88	176

# los 05

ref	descripción/description	acabado/finish	u	p/u	total
<b>ESTRUCTURA/STRUCTURE</b>					
IS_110S152	IOS v a suelo . separador 5h L3,5 H181,5 F42 IOS floor v . divider 5h W3.5 H181.5 D42	laca mate matt lacquer	6	124	744
IS_120M352	IOS v a suelo . m librería 5h L64 H181,5 F42 IOS floor v . bookcase module 5h W64 H181.5 D42	laca mate matt lacquer	1	400	400
IS_140M752	IOS v a suelo . m panel tv (módulo) 5h L163,5 H181,5 F42 IOS floor v . tv panel module (module) 5h W163.5 H181.5 D42	laca mate matt lacquer	1	226	226
IS_141M71	IOS v a suelo . m panel tv (panel) L163,5 H103 IOS floor v . tv panel module (tv panel) W163.5 H103	laca mate matt lacquer	1	170	170
IS_142M712	IOS v a suelo . m panel tv (cajonera) L163,5 H48 F50 IOS floor v . tv panel module (tv drawer) W163.5 H42 D50	eucalipto ahumado smoked eucalyptus	1	702	702
IS_120M352	IOS v a suelo . m librería 5h L64 H181,5 F42 IOS floor v . bookcase module 5h W64 H181.5 D42	laca mate matt lacquer	1	400	400
IS_120M552	IOS v a suelo . m librería 5h L96 H181,5 F42 IOS floor v . bookcase module 5h W96 H181.5 D42	laca mate matt lacquer	2	504	1008
<b>COMPLEMENTOS/COMPLEMENTS</b>					
IS_510C512_1	IOS f interiores . IN jgo 2 cajones 1h L96 H32 F42 tirador embutido negro IOS inner fronts . IN set 2 drawers 1h W96 H32 D42 inlay black handle	eucalipto ahumado smoked eucalyptus	2	244	488
AC_22	ACCESORIOS . guía corredera ONLY aluminio (juego) L202,5 ACCESSORIES . ONLY aluminium sliding guide (set) W202,5		1	101	101
IS_721P55	IOS f correderos . ONLY puerta cristal 5h L99 H177 IOS sliding fronts . ONLY glass door 5h W99 H177	metal negro / dark grey black metal / dark grey	1	674	674
			<b>TOTAL</b>	<b>4913</b>	
<b>ILUMINACION (OPCIONAL) / LIGHTING (OPTION)</b>					
IS_463L7	IOS e comunes . led panel tv con interruptor L163,5 IOS common elements . led panel tv with switch W163,5	metal negro / dark grey black metal / dark grey	1	98	98
AC_511	ACCESORIOS . iluminación transformador . 30w ACCESSORIES . transformer lighting . 30w		1	64	64

# los 06

ref	descripción/description	acabado/finish	u	p/u	total
<b>ESTRUCTURA/STRUCTURE</b>					
IS_110S152	IOS v a suelo . separador 5h L3,5 H181,5 F42 IOS floor v . divider 5h W3.5 H181.5 D42	roble oak	6	160	960
IS_120M552	IOS v a suelo . m librería 5h L96 H181,5 F42 IOS floor v . bookcase module 5h W96 H181.5 D42	roble oak	1	680	680
IS_120M252	IOS v a suelo . m librería 5h L48 H181,5 F42 IOS floor v . bookcase module 5h W48 H181.5 D42	roble oak	1	448	448
IS_140M752	IOS v a suelo . m panel tv (módulo) 5h L163,5 H181,5 F42 IOS floor v . tv panel module (module) 5h W163.5 H181.5 D42	roble oak	1	310	310
IS_141M71	IOS v a suelo . m panel tv (panel) L163,5 H103 IOS floor v . tv panel module (tv panel) W163.5 H103	laca mate matt lacquer	1	170	170
IS_142M712	IOS v a suelo . m panel tv (cajonera) L163,5 H48 F50 IOS floor v . tv panel module (tv drawer) W163.5 H42 D50	laca mate matt lacquer	1	480	480
IS_120M252	IOS v a suelo . m librería 5h L48 H181,5 F42 IOS floor v . bookcase module 5h W48 H181.5 D42	roble oak	1	448	448
IS_150M552	IOS v a suelo . m escritorio (módulo) 5h L96 H181,5 F42 IOS floor v . desktop module (module) 5h W96 H181.5 D42	roble oak	1	506	506
IS_151M512	IOS v a suelo . m escritorio (estante) L96 H4,5 F50 IOS floor v . desktop module (desk shelf) W96 H4.5 D50	laca mate matt lacquer	1	110	110
IS_420E512	IOS e comunes . estante madera L96 H3,5 F42 IOS common elements . wooden shelf W96 H3.5 D42	roble oak	-4	90	-360
IS_430E512	IOS e comunes . estante cristal L96 F42 IOS common elements . glass shelf W96 H0.6 D42	transparente transparent	4	42	168
<b>COMPLEMENTOS/COMPLEMENTS</b>					
IS_672P55	IOS f solapados . AIR jgo puertas cristal bat 5h L99 H177 IOS overlapping fronts . AIR hinged glass doors set 5h W99 H177	metal negro / transparente black metal / transparent	1	620	620
			<b>TOTAL</b>	<b>4540</b>	
<b>ILUMINACION (OPCIONAL) / LIGHTING (OPTION)</b>					
IS_460L5	IOS e comunes . led estante sin interruptor L96 IOS common elements . led shelf without switch W96		1	50	50
AC_52	ACCESORIOS . iluminación control remoto (interruptor sin cable) ACCESSORIES . remote control lighting (cordless switch)		1	68	68
IS_463L7	IOS e comunes . led panel tv con interruptor L163,5 IOS common elements . led panel tv with switch W163,5		1	98	98
IS_461L5	IOS e comunes . led estante con interruptor L96 IOS common elements . led shelf with switch W96		1	70	70
AC_512	ACCESORIOS . iluminación transformador . 75w ACCESSORIES . transformer lighting . 75w		1	88	88

ref	descripción/description	acabado/finish	u	p/u	total
<b>ESTRUCTURA/STRUCTURE</b>					
IS_110S152	IOS v a suelo . separador 5h L3,5 H181,5 F42 IOS floor v . divider 5h W3.5 H181.5 D42	laca mate matt lacquer	6	124	744
IS_120M352	IOS v a suelo . m librería 5h L64 H181,5 F42 IOS floor v . bookcase module 5h W64 H181.5 D42	laca mate matt lacquer	1	400	400
IS_130M652	IOS v a suelo . m tv 5h L131,5 H181,5 F42 IOS floor v . tv module 5h W131.5 H181.5 D42	laca mate matt lacquer	1	466	466
IS_120M452	IOS v a suelo . m librería 5h L80 H181,5 F42 IOS floor v . bookcase module 5h W80 H181.5 D42	laca mate matt lacquer	3	452	1356
IS_410S112	IOS e comunes . separador interior 1h L3,5 H32 F40 CTex IOS common elements . fixed inner dividers 1h W3.5 H32 D40 CTex	laca mate matt lacquer	1	66	66
<b>COMPLEMENTOS/COMPLEMENTS</b>					
IS_670P35	IOS f solapados . AIR puerta cristal bat iz 5h L67 H177 IOS overlapping fronts . AIR hinged glass door left 5h W67 H177	metal negro / dark grey black metal / dark grey	1	382	382
IS_510C412_0	IOS f interiores . IN jgo 2 cajones 1h L80 H32 F42 sin tirador IOS inner fronts . IN set 2 drawers 1h W80 H32 D42 handleless	laca mate matt lacquer	1	186	186
AC_22	ACCESORIOS . guia corredera ONLY aluminio (juego) L254 ACCESSORIES . ONLY aluminium sliding guide (set) W254		1	127	127
IS_720P45	IOS f correderos . ONLY puerta madera 5h L83 H177 IOS sliding fronts . ONLY wooden door 5h W83 H177	roble oak	1	444	444
<b>TOTAL</b>					<b>4171</b>
<b>ILUMINACION (OPCIONAL) / LIGHTING (OPTION)</b>					
IS_460L3	IOS e comunes . led estante sin interruptor L64 IOS common elements . led shelf without swith W64		5	42	210
AC_512	ACCESORIOS . iluminación transformador . 75w ACCESSORIES . transformer lighting . 75w		1	88	88
AC_52	ACCESORIOS . iluminación control remoto (interruptor sin cable) ACCESSORIES . remote control lighting (cordless switch)		1	68	68

ref	descripción/description	acabado/finish	u	p/u	total
<b>ESTRUCTURA/STRUCTURE</b>					
IS_110S152	IOS v a suelo . separador 5h L3,5 H181,5 F42 IOS floor v . divider 5h W3.5 H181.5 D42	roble oak	4	160	640
IS_120M652	IOS v a suelo . m librería 5h L131,5 H181,5 F42 IOS floor v . bookcase module 5h W131.5 H181.5 D42	laca mate matt lacquer	1	628	628
IS_420E612	IOS e comunes . estante madera L131,5 H3,5 F42 IOS common elements . wooden shelf W131,5 H3,5 D42	laca mate matt lacquer	-6	84	-504
IS_420E612	IOS e comunes . estante madera L131,5 H3,5 F42 IOS common elements . wooden shelf W131,5 H3,5 D42	roble oak	6	110	660
IS_130M652	IOS v a suelo . m tv 5h L131,5 H181,5 F42 IOS floor v . tv module 5h W131.5 H181.5 D42	laca mate matt lacquer	1	466	466
IS_420E612	IOS e comunes . estante madera L131,5 H3,5 F42 IOS common elements . wooden shelf W131,5 H3,5 D42	laca mate matt lacquer	-4	84	-336
IS_420E612	IOS e comunes . estante madera L131,5 H3,5 F42 IOS common elements . wooden shelf W131,5 H3,5 D42	roble oak	4	110	440
IS_120M652	IOS v a suelo . m librería 5h L131,5 H181,5 F42 IOS floor v . bookcase module 5h W131.5 H181.5 D42	laca mate matt lacquer	1	628	628
IS_420E612	IOS e comunes . estante madera L131,5 H3,5 F42 IOS common elements . wooden shelf W131,5 H3,5 D42	laca mate matt lacquer	-6	84	-504
IS_420E612	IOS e comunes . estante madera L131,5 H3,5 F42 IOS common elements . wooden shelf W131,5 H3,5 D42	roble oak	6	110	660
IS_410S112	IOS e comunes . separador interior 1h L3,5 H32 F40 CTex . IOS common elements . fixed inner dividers 1h W3.5 H32 D40 CTex	roble oak	1	70	70
<b>COMPLEMENTOS/COMPLEMENTS</b>					
AC_21	ACCESORIOS . guia corredera PLAY aluminio negro L406,5 ACCESSORIES . PLAY black aluminum sliding guide W406,5	tapeta roble oak front cover	2	244	488
IS_711P63	IOS f correderos . PLAY puerta cristal 3h L134,5 H106 IOS sliding fronts . PLAY glass door 3h W134.5 H106	metal negro / dark grey black metal / dark grey	1	406	406
IS_811C612	IOS cubos . DEC multimedia 1h L131,5 H32 F42 IOS cubes . DEC multimedia cube 1h W131.5 H32 D42	laca mate matt lacquer	1	310	310
IS_510C312	IOS f interiores . IN jgo 2 cajones 1h L64 H32 F42 sin tirador IOS inner fronts . IN set 2 drawers 1h W64 H32 D42 handleless	laca mate matt lacquer	1	172	172
IS_450A111	IOS e comunes . apoyo int recto L3,5 H32 F28 IOS common elements . free inner divider W3.5 H32 D28	roble oak	2	34	68
IS_451A111	IOS e comunes . apoyo int forma L32 H32 F28 IOS common elements . free inner divider U W32 H32 D28	laca mate matt lacquer	2	60	120
<b>TOTAL</b>					<b>4412</b>
<b>ILUMINACION (OPCIONAL) / LIGHTING (OPTION)</b>					
IS_460L6	IOS e comunes . led estante sin interruptor L131,5 IOS common elements . led shelf without swith W131,5		3	66	198
AC_52	ACCESORIOS . iluminación control remoto (interruptor sin cable) ACCESSORIES . remote control lighting (cordless switch)		1	68	68
AC_512	ACCESORIOS . iluminación transformador . 75w ACCESSORIES . transformer lighting . 75w		1	88	88

# los 09

ref	descripción/description	acabado/finish	u	p/u	total
<b>ESTRUCTURA/STRUCTURE</b>					
IS_110S152	IOS v a suelo . separador 5h L3,5 H181,5 F42 IOS floor v . divider 5h W3.5 H181.5 D42	laca mate matt lacquer	5	124	620
IS_120M552	IOS v a suelo . m librería 5h L96 H181,5 F42 IOS floor v . bookcase module 5h W96 H181.5 D42	laca mate matt lacquer	1	504	504
IS_130M652	IOS v a suelo . m tv 5h L131,5 H181,5 F42 IOS floor v . tv module 5h W131.5 H181.5 D42	laca mate matt lacquer	1	466	466
IS_120M252	IOS v a suelo . m librería 5h L48 H181,5 F42 IOS floor v . bookcase module 5h W48 H181.5 D42	laca mate matt lacquer	1	348	348
IS_120M352	IOS v a suelo . m librería 5h L64 H181,5 F42 IOS floor v . bookcase module 5h W64 H181.5 D42	laca mate matt lacquer	1	400	400
IS_420E312	IOS e comunes . estante madera L64 H3,5 F42 IOS common elements . wooden shelf W64 H3.5 D42	laca mate matt lacquer	-2	58	-116
IS_430E312	IOS e comunes . estante cristal L64 F42 IOS common elements . glass shelf W64 H0.6 D42	transparente transparent	2	34	68
<b>COMPLEMENTOS/COMPLEMENTS</b>					
IS_510C512_1	IOS f interiores . IN jgo 2 cajones 1h L96 H32 F42 tirador embutido negro IOS inner fronts . IN set 2 drawers 1h W96 H32 D42 inlay black handle	laca mate matt lacquer	1	216	216
IS_811C612	IOS cubos . DEC multimedia 1h L131,5 H32 F42 IOS cubos . DEC multimedia cube 1h W131.5 H32 D42	roble oak	1	460	460
IS_812C632	IOS cubos . DEC tv 3h L131,5 H103 F42 IOS cubos . DEC cube tv 3h W131.5 H103 D42	roble oak	1	488	488
IS_671P33	IOS f solapados . AIR puerta cristal bat de 3h L67 H106 IOS overlapping fronts . AIR hinged glass door right 3h W67 H106	metal negro / dark grey black metal / dark grey	1	306	306
			<b>TOTAL</b>	<b>3760</b>	
<b>ILUMINACION (OPCIONAL) / LIGHTING (OPTION)</b>					
IS_460L3	IOS e comunes . led estante sin interruptor L64 IOS common elements . led shelf without swith W64		1	42	42
AC_52	ACCESORIOS . iluminación control remoto (interruptor sin cable) ACCESSORIES . remote control lighting (cordless switch)		1	68	68
AC_511	ACCESORIOS . iluminación transformador . 30w ACCESSORIES . transformer lighting . 30w		1	64	64

# los 10

LOYRATIME 1401141

ref	descripción/description	acabado/finish	u	p/u	total
<b>ESTRUCTURA/STRUCTURE</b>					
IS_110S122	IOS v a suelo . separador 2h L3,5 H75 F42 IOS floor v . divider 2h W3.5 H75 D42	roble oak	4	100	400
IS_120M522	IOS v a suelo . m librería 2h L96 H75 F42 IOS floor v . bookcase module 2h W96 H75 D42	roble oak	3	330	990
<b>COMPLEMENTOS/COMPLEMENTS</b>					
IS_440E012	IOS e comunes . encimera cml H1,3 F42 L302 IOS common elements . top cover cml H1.3 D42 W302	laca mate matt lacquer	1	181	181
AC_21	ACCESORIOS . guia corredera PLAY aluminio negro L300 ACCESSORIES . PLAY black aluminum sliding guide W300	tapeta roble oak front cover	2	180	360
IS_710P52	IOS f correderos . PLAY puerta madera 2h L99 H70,5 IOS sliding fronts . PLAY wooden door 2h W99 H70,5	laca mate matt lacquer	1	168	168
IS_510C512_0	IOS f interiores . IN jgo 2 cajones 1h L96 H32 F42 sin tirador IOS inner fronts . IN set 2 drawers 1h W96 H32 D42 handleless	laca mate matt lacquer	1	200	200
			<b>TOTAL</b>	<b>2299</b>	



# los 11

ref	descripción/description	acabado/finish	u	p/u	total
<b>ESTRUCTURA/STRUCTURE</b>					
IS_310S152	IOS v suspendida . separador 5h L3,5 H181 F42 IOS suspended v . divider 5h W3.5 H181 D42	laca mate matt lacquer	7	142	994
IS_320M252	IOS v suspendida . m librería 5h L48 H181 F42 IOS suspended v . bookcase module 5h W48 H181 D42	laca mate matt lacquer	2	304	608
IS_320M552	IOS v suspendida . m librería 5h L96 H181 F42 IOS suspended v . bookcase module 5h W96 H181 D42	laca mate matt lacquer	1	420	420
IS_320M252	IOS v suspendida . m librería 5h L48 H181 F42 IOS suspended v . bookcase module 5h W48 H181 D42	laca mate matt lacquer	2	304	608
IS_320M552	IOS v suspendida . m librería 5h L96 H181 F42 IOS suspended v . bookcase module 5h W96 H181 D42	laca mate matt lacquer	1	420	420
IS_420E212	IOS e comunes . estante madera L48 H3,5 F42 IOS common elements . wooden shelf W48 H3,5 D42	laca mate matt lacquer	-1	52	-52
<b>COMPLEMENTOS/COMPLEMENTS</b>					
IS_810C212	IOS cubos . DEC 1h L48 H32 F42 IOS cubes . DEC cube 1h W48 H32 D42	laca mate matt lacquer	1	128	128
IS_810C512	IOS cubos . DEC 1h L96 H32 F42 IOS cubes . DEC cube 1h W96 H32 D42	laca mate matt lacquer	2	184	368
IS_810C222	IOS cubos . DEC 2h L48 H67,5 F42 IOS cubes . DEC cube 2h W48 H67,5 D42	laca mate matt lacquer	1	212	212
			<b>TOTAL</b>	<b>3706</b>	

# los 12

ref	descripción/description	acabado/finish	u	p/u	total
<b>ESTRUCTURA/STRUCTURE</b>					
IS_310S142	IOS v suspendida . separador 4h L3,5 H145,5 F42 IOS suspended v . divider 4h W3.5 H145.5 D42	roble oak	6	156	936
IS_320M242	IOS v suspendida . m librería 4h L48 H145,5 F42 IOS suspended v . bookcase module 4h W48 H145.5 D42	roble oak	1	310	310
IS_340M742	IOS v suspendida . m panel tv (módulo) 4h L163,5 H145,5 F42 IOS suspended v . tv panel module (module) 4h W163.5 H145.5 D42	roble oak	1	128	128
IS_341M71	IOS v suspendida . m panel tv (panel) L163,5 H103 IOS suspended v . tv panel module (tv panel) W163.5 H103	laca mate matt lacquer	1	170	170
IS_342M712	IOS v suspendida . m panel tv (cajonera) L163,5 H48 F50 IOS suspended v . tv panel module (tv drawer) W163,5 H42 D50	laca mate matt lacquer	1	480	480
IS_320M242	IOS v suspendida . m librería 4h L48 H145,5 F42 IOS suspended v . bookcase module 4h W48 H145.5 D42	roble oak	1	310	310
IS_320M542	IOS v suspendida . m librería 4h L96 H145,5 F42 IOS suspended v . bookcase module 4h W96 H145.5 D42	roble oak	2	448	896
IS_420E512	IOS e comunes . estante madera L96 H3,5 F42 IOS common elements . wooden shelf W96 H3,5 D42	roble oak	-6	90	-540
IS_430E512	IOS e comunes . estante cristal L96 F42 IOS common elements . glass shelf W96 H0,6 D42	transparente transparent	6	42	252
IS_390T54	IOS v suspendida . trasera 4h L96 H138,5 IOS suspended v . rear panel 4h W96 H138.5	laca mate matt lacquer	2	90	180
<b>COMPLEMENTOS/COMPLEMENTS</b>					
IS_672P54	IOS f solapados . AIR jgo puertas cristal bat 4h L99 H141,5 IOS overlapping fronts . AIR hinged glass doors set 4h W99 H141.5	metal negro / dark grey black metal / dark grey	2	610	1220
			<b>TOTAL</b>	<b>4342</b>	
<b>ILUMINACION (OPCIONAL) / LIGHTING (OPTION)</b>					
IS_463L7	IOS e comunes . led panel tv con interruptor L163,5 IOS common elements . led panel tv with switch W163,5		1	98	98
IS_460L5	IOS e comunes . led estante sin interruptor L96 IOS common elements . led shelf without swith W96		2	50	100
AC_52	ACCESORIOS . iluminación control remoto (interruptor sin cable) ACCESSORIES . remote control lighting (cordless switch)		1	68	68
AC_512	ACCESORIOS . iluminación transformador . 75w ACCESSORIES . transformer lighting . 75w		1	88	88

# los 13

ref	descripción/description	acabado/finish	u	p/u	total
<b>ESTRUCTURA/STRUCTURE</b>					
IS_310S142	IOS v suspendida . separador 4h L3,5 H145,5 F42 IOS suspended v . divider 4h W3.5 H145.5 D42	laca mate matt lacquer	6	128	768
IS_350M542	IOS v suspendida . m escritorio (módulo) 4h L96 H145,5 F42 IOS suspended v . desktop module (module) 4h W96 H145.5 D42	laca mate matt lacquer	1	140	140
IS_351M512	IOS v suspendida . m escritorio (estante) L96 H4,5 F50 IOS suspended v . desktop module (desk shelf) W96 H4.5 D52	laca mate matt lacquer	1	114	114
IS_320M242	IOS v suspendida . m librería 4h L48 H145,5 F42 IOS suspended v . bookcase module 4h W48 H145.5 D42	laca mate matt lacquer	1	254	254
IS_340M742	IOS v suspendida . m panel tv (módulo) 4h L163,5 H145,5 F42 IOS suspended v . tv panel module (module) 4h W163.5 H145.5 D42	laca mate matt lacquer	1	98	98
IS_341M71	IOS v suspendida . m panel tv (panel) L163,5 H103 IOS suspended v . tv panel module (tv panel) W163.5 H103	laca mate matt lacquer	1	170	170
IS_342M712	IOS v suspendida . m panel tv (cajonera) L163,5 H48 F50 IOS suspended v . tv panel module (tv drawer) W163.5 H42 D52	roble oak	1	616	616
IS_320M242	IOS v suspendida . m librería 4h L48 H145,5 F42 IOS suspended v . bookcase module 4h W48 H145.5 D42	laca mate matt lacquer	1	254	254
IS_320M342	IOS v suspendida . m librería 4h L64 H145,5 F42 IOS suspended v . bookcase module 4h W64 H145.5 D42	laca mate matt lacquer	1	286	286
IS_420E312	IOS e comunes . estante madera L64 H3,5 F42 IOS common elements . wooden shelf W64 H3.5 D42	laca mate matt lacquer	-3	58	-174
IS_430E312	IOS e comunes . estante cristal L64 F42 IOS common elements . glass shelf W64 H0.6 D42	transparente transparent	3	34	102
IS_391T51	IOS v suspendida . trasera m escritorio inf L96 H42 IOS suspended v . desk module lower rear panel W96 H42	laca mate matt lacquer	1	42	42
IS_391T52	IOS v suspendida . trasera m escritorio sup L96 H92 IOS suspended v . desk module upper rear panel W96 H92	laca mate matt lacquer	1	66	66
IS_390T34	IOS v suspendida . trasera 4h L64 H138,5 IOS suspended v . rear panel 4h W64 H138.5	laca mate matt lacquer	1	66	66
<b>COMPLEMENTOS/COMPLEMENTS</b>					
IS_671P34	IOS f solapados . AIR puerta cristal bat de 4h L67 H141,5 IOS overlapping fronts . AIR hinged glass door right 4h W67 H141,5	metal negro/dark grey black metal/dark grey	1	342	342
<b>TOTAL</b>					<b>3144</b>
<b>ILUMINACION (OPCIONAL) / LIGHTING (OPTION)</b>					
IS_461L5	IOS e comunes . led estante con interruptor L96 IOS common elements . led shelf with switch W96		1	70	70
IS_463L7	IOS e comunes . led panel tv con interruptor L163,5 IOS common elements . led panel tv with switch W163,5		1	98	98
IS_460L3	IOS e comunes . led estante sin interruptor L64 IOS common elements . led shelf without swith W64		1	42	42
AC_52	ACCESORIOS . iluminación control remoto (interruptor sin cable) ACCESSORIES . remote control lighting (cordless switch)		1	68	68
AC_512	ACCESORIOS . iluminación transformador . 75w ACCESSORIES . transformer lighting . 75w		1	88	88

# los 14

ref	descripción/description	acabado/finish	u	p/u	total
<b>ESTRUCTURA/STRUCTURE</b>					
IS_310S142	IOS v suspendida . separador 4h L3,5 H145,5 F42 IOS suspended v . divider 4h W3.5 H145.5 D42	roble oak	6	156	936
IS_320M542	IOS v suspendida . m librería 4h L96 H145,5 F42 IOS suspended v . bookcase module 4h W96 H145.5 D42	roble oak	1	448	448
IS_320M142	IOS v suspendida . m librería 4h L32 H145,5 F42 IOS suspended v . bookcase module 4h W32 H145.5 D42 . oak	roble oak	1	264	264
IS_340M642	IOS v suspendida . m panel tv (módulo) 4h L131,5 H145,5 F42 IOS suspended v . tv panel module (module) 4h W131.5 H145.5 D42	roble oak	1	110	110
IS_341M61	IOS v suspendida . m panel tv (panel) L131,5 H103 IOS suspended v . tv panel module (tv panel) W131.5 H103	laca mate matt lacquer	1	140	140
IS_342M612	IOS v suspendida . m panel tv (cajonera) L131,5 H48 F50 IOS suspended v . tv panel module (tv drawer) W131.5 H42 D50	laca mate matt lacquer	1	432	432
IS_320M142	IOS v suspendida . m librería 4h L32 H145,5 F42 IOS suspended v . bookcase module 4h W32 H145.5 D42	roble oak	1	264	264
IS_320M542	IOS v suspendida . m librería 4h L96 H145,5 F42 IOS suspended v . bookcase module 4h W96 H145.5 D42	roble oak	1	448	448
<b>COMPLEMENTOS/COMPLEMENTS</b>					
IS_642P54	IOS f solapados . STEP jgo puertas madera bat 4h L99 H141,5 IOS overlapping fronts . STEP hinged wooden doors set 4h W99 H141.5	laca mate matt lacquer	1	310	310
IS_510C512	IOS f interiores . IN jgo 2 cajones 1h L96 H32 F42 tirador embutido negro IOS inner fronts . IN set 2 drawers 1h W96 H32 D42 inlay black handle	laca mate matt lacquer	1	216	216
<b>TOTAL</b>					<b>3568</b>
<b>ILUMINACION (OPCIONAL) / LIGHTING (OPTION)</b>					
IS_463L6	IOS e comunes . led panel tv con interruptor L131,5 IOS common elements . led panel tv with switch W131,5		1	92	92
AC_511	ACCESORIOS . iluminación transformador . 30w ACCESSORIES . transformer lighting . 30w		1	64	64

# los 15

ref	descripción/description	acabado/finish	u	p/u	total
<b>ESTRUCTURA/STRUCTURE</b>					
IS_310S142	IOS v suspendida . separador 4h L3,5 H145,5 F42 IOS suspended v . divider 4h W3,5 H145,5 D42	laca mate matt lacquer	4	128	512
IS_320M542	IOS v suspendida . m librería 4h L96 H145,5 F42 IOS suspended v . bookcase module 4h W96 H145,5 D42	laca mate matt lacquer	1	350	350
IS_330M642	IOS v suspendida . m tv 4h L131,5 H145,5 F42 IOS suspended v . tv module 4h W131,5 H145,5 D42	laca mate matt lacquer	1	252	252
IS_320M542	IOS v suspendida . m librería 4h L96 H145,5 F42 IOS suspended v . bookcase module 4h W96 H145,5 D42	laca mate matt lacquer	1	350	350
IS_420E512	IOS e comunes . estante madera L96 H3,5 F42 IOS common elements . wooden shelf W96 H3,5 D42	laca mate matt lacquer	-1	70	-70
IS_430E512	IOS e comunes . estante cristal L96 F42 IOS common elements . glass shelf W96 H0,6 D42	transparente transparent	1	42	42
IS_390T53	IOS v suspendida . trasera 3h L96 H103 IOS suspended v . rear panel 3h W96 H103	laca mate matt lacquer	1	72	72
<b>COMPLEMENTOS/COMPLEMENTS</b>					
IS_672P52	IOS f solapados . AIR jgo puertas cristal bat 2h L99 H70,5 IOS overlapping fronts . AIR hinged glass doors set 2h W99 H70,5	metal negro / transparente black metal / transparent	1	458	458
IS_811C712	IOS cubos . DEC multimedia 1h L163,5 H32 F42 IOS cubes . DEC multimedia cube 1h W163,5 H32 D42	roble oak	1	524	524
IS_510C512_1	IOS f interiores . IN jgo 2 cajones 1h L96 H32 F42 tirador embutido negro IOS inner fronts . IN set 2 drawers 1h W96 H32 D42 inlay black handle	laca mate matt lacquer	1	216	216
<b>TOTAL</b>					<b>2706</b>

# los 16

ref	descripción/description	acabado/finish	u	p/u	total
<b>ESTRUCTURA/STRUCTURE</b>					
IS_310S132	IOS v suspendida . separador 3h L3,5 H110 F42 IOS suspended v . divider 3h W3,5 H110 D42	laca mate matt lacquer	3	114	342
IS_320M732	IOS v suspendida . m librería 3h L163,5 H110 F42 IOS suspended v . bookcase module 3h W163,5 H110 D42	laca mate matt lacquer	1	388	388
IS_330M732	IOS v suspendida . m tv 3h L163,5 H110 F42 IOS suspended v . tv module 3h W163,5 H110 D42	laca mate matt lacquer	1	194	194
IS_410S112_1	IOS e comunes . separador interior 1h L3,5 H32 F40 CTex IOS common elements . fixed inner dividers 1h W3,5 H32 D40 CTex	laca mate matt lacquer	1	66	66
<b>COMPLEMENTOS/COMPLEMENTS</b>					
AC_21	ACCESORIOS . guia corredera PLAY aluminio negro L335,5 ACCESSORIES . PLAY black aluminum sliding guide W335,5	tapeta laca mate matt lacquer front cover	2	201	402
IS_711P73	IOS f correderos . PLAY puerta cristal 3h L166,5 H106 IOS sliding fronts . PLAY glass door 3h W166,5 H106	metal negro / dark grey black metal / dark grey	1	442	442
IS_510C412_1	IOS f interiores . IN jgo 2 cajones 1h L80 H32 F42 tirador embutido negro IOS inner fronts . IN set 2 drawers 1h W80 H32 D42 inlay black handle	laca mate matt lacquer	1	202	202
IS_440E011	IOS e comunes . encimera cml H1,3 F32 L337,5 IOS common elements . top cover cml H1,3 D32 W337,5	laca mate matt lacquer	1	169	169
<b>TOTAL</b>					<b>2205</b>

# los 17

ref	descripción/description	acabado/finish	u	p/u	total
	<b>ESTRUCTURA/STRUCTURE</b>				
IS_310S122	IOS v suspendida . separador 2h L3,5 H74,5 F42 IOS suspended v . divider 2h W3.5 H74.5 D42	roble oak	5	116	580
IS_320M522	IOS v suspendida . m librería 2h L96 H74,5 F42 IOS suspended v . bookcase module 2h W96 H74.5 D42	roble oak	2	268	536
IS_320M222	IOS v suspendida . m librería 2h L48 H74,5 F42 IOS suspended v . bookcase module 2h W48 H74.5 D42	roble oak	2	186	372
IS_420E512	IOS e comunes . estante madera L96 H3,5 F42 IOS common elements . wooden shelf W96 H3,5 D42	roble oak	-1	90	-90
IS_430E512	IOS e comunes . estante cristal L96 F42 IOS common elements . glass shelf W96 H0.6 D42	transparente transparent	1	42	42
IS_390T52_lm	IOS v suspendida . trasera 2h L96 H67,5 IOS suspended v . rear panel 2h W96 H67,5	laca mate matt lacquer	1	54	54
	<b>COMPLEMENTOS/COMPLEMENTS</b>				
IS_440E012	IOS e comunes . encimera cml H1,3 F42 L305,5 IOS common elements . top cover cml H1.3 D42 W305,5	roble oak	1	183	183
AC_21	ACCESORIOS . guía corredera PLAY aluminio negro L303,5 ACCESSORIES . PLAY black aluminum sliding guide W303,5	tapeta roble oak front cover	2	182	364
IS_711P52	IOS f correderos . PLAY puerta cristal 2h L99 H70,5 IOS sliding fronts . PLAY glass door 2h W99 H70,5	metal negro / dark grey black metal / dark grey	1	298	298
IS_510C512_0	IOS f interiores . IN jgo 2 cajones 1h L96 H32 F42 sin tirador IOS inner fronts . IN set 2 drawers 1h W96 H32 D42 handleless	laca mate matt lacquer	1	200	200
				<b>TOTAL</b>	<b>2539</b>
	<b>ILUMINACION (OPCIONAL) / LIGHTING (OPTION)</b>				
IS_460L5	IOS e comunes . led estante sin interruptor L96 IOS common elements . led shelf without swith W96		1	50	50
AC_52	ACCESORIOS . iluminación control remoto (interruptor sin cable) ACCESSORIES . remote control lighting (cordless switch)		1	68	68
AC_511	ACCESORIOS . iluminación transformador . 30w ACCESSORIES . transformer lighting . 30w		1	64	64

# los 18

ref	descripción/description	acabado/finish	u	p/u	total
	<b>ESTRUCTURA/STRUCTURE</b>				
IS_310S112	IOS v suspendida . separador 1h L3,5 H39 F42 IOS suspended v . divider 1h W3.5 H39 D42	roble oak	5	96	480
IS_320M412	IOS v suspendida . m librería 1h L80 H39 F42 IOS suspended v . bookcase module 1h W80 H39 D42	roble oak	4	162	648
	<b>COMPLEMENTOS/COMPLEMENTS</b>				
IS_440E012	IOS e comunes . encimera cml H1,3 F42 L337,5 IOS common elements . top cover cml H1.3 D42 W337,5	roble oak	1	169	169
AC_21	ACCESORIOS . guía corredera PLAY aluminio negro L335,5 ACCESSORIES . PLAY black aluminum sliding guide W335,5	tapeta roble oak front cover	2	201	402
IS_710P41	IOS f correderos . PLAY puerta madera 1h L83 H35 IOS sliding fronts . PLAY wooden door 1h W83 H35	laca mate matt lacquer	2	126	252
IS_510C412_1	IOS f interiores . IN jgo 2 cajones 1h L80 H32 F42 tirador embutido negro IOS inner fronts . IN set 2 drawers 1h W80 H32 D42 inlay black handle	laca mate matt lacquer	1	202	202
OP_110	OPCIONAL . incremento metal lacado . tirador embutido OPTIONAL . lacquered metal increment . inlay handle	laca mate matt lacquer	2	10	20
				<b>TOTAL</b>	<b>2173</b>

# Moss 01

ref	descripción/description	acabado/finish	u	p/u	total
	<b>ESTRUCTURA/STRUCTURE</b>				
MO_110S51	MOSS v patas metálicas . aparador simétrico 1h L263,5 H53 F44 MOSS metal legs v . symmetric sideboards 1h W263.5 H53 D44	metal negro / laca mate black metal / matt lacquer	1	1064	1064
	acabado exterior outer finish	laca mate matt lacquer			
	acabado interior inner finish	laca mate matt lacquer			
	patas metálicas metal legs	metal negro black metal			
	<b>COMPLEMENTOS/COMPLEMENTS</b>				
MO_470P31	MOSS frentes . BET puerta cristal bat iz 1h L64 H32 MOSS accessories . BET left hinged glass door 1h W64 H32	metal negro / transparente black metal / transparent	1	268	268
MO_471P31	MOSS frentes . BET puerta cristal bat de 1h L64 H32 MOSS accessories . BET right hinged glass door 1h W64 H32	metal negro / transparente black metal / transparent	1	268	268
OP_115	OPCIONAL . incremento metal lacado . puerta cristal BET 1h L64 H32 OPTIONAL . lacquered metal increment . BET glass door 1h W64 H32	laca mate matt lacquer	2	20	40
MO_410C31_2	MOSS frentes . jgo 2 cajones 1h L64 H32 tirador pomo negro MOSS accessories . set 2 drawers 1h W64 H32 knob black handle	laca mate matt lacquer	1	188	188
<b>TOTAL</b>					<b>1828</b>

# Moss 02

LOYRATIME 150 I 151

ref	descripción/description	acabado/finish	u	p/u	total
	<b>ESTRUCTURA/STRUCTURE</b>				
MO_220A51	MOSS v suspendida . aparador asimétrico 1h L263,5 H35 F44 MOSS suspended v . asymmetric sideboard 1h W263.5 H35 D44	laca mate matt lacquer	1	900	900
	acabado exterior outer finish	laca mate matt lacquer			
	acabado interior inner finish	laca mate matt lacquer			
	<b>COMPLEMENTOS/COMPLEMENTS</b>				
MO_522E31	MOSS accesorios . estante madera suelto L64 H2 MOSS loose wooden shelf W64 H2	laca mate matt lacquer	1	42	42
MO_410C31_1	MOSS frentes . jgo 2 cajones 1h L64 H32 tirador embutido negro MOSS accessories . set 2 drawers 1h W64 H32 inlay black handle	laca mate matt lacquer	1	192	192
MO_442P21	MOSS frentes . jgo puertas madera bat 1h L80 H32 MOSS accessories . hinged wooden doors set 1h W80 H32	laca mate matt lacquer	1	120	120
MO_471P21	MOSS frentes . BET puerta cristal bat de 1h L48 H32 . MOSS accessories . BET right hinged glass door 1h W48 H32	metal negro / dark grey black metal / dark grey	1	262	262
<b>TOTAL</b>					<b>1516</b>

# Moss 03

ref	descripción/description	acabado/finish	u	p/u	total
	<b>ESTRUCTURA/STRUCTURE</b>				
MO_320A41	MOSS v zócalo . aparador asimétrico 1h L231,5 H39 F44 MOSS plate base v . asymetric sideboard 1h W231.5 H39 D44		1	842	842
	acabado exterior outer finish	roble oak			
	acabado interior inner finish	laca mate matt lacquer			
	<b>COMPLEMENTOS/COMPLEMENTS</b>				
MO_442P21	MOSS frentes . jgo puertas madera bat 1h L80 H32 MOSS accessories . hinged wooden doors set 1h W80 H32	laca brillo high gloss lacquer	2	136	272
<b>TOTAL</b>					<b>1114</b>

# Moss 04

ref	descripción/description	acabado/finish	u	p/u	total
	<b>ESTRUCTURA/STRUCTURE</b>				
MO_120A31	MOSS v patas metálicas . aparador asimétrico 1h L199,5 H53 F44 MOSS metal legs v . asymetric sideboard 1h W199.5 H53 D44		1	930	930
	acabado exterior outer finish	eucalipto ahumado smoked eucalyptus			
	acabado interior inner finish	laca mate matt lacquer			
	patas metálicas metal legs	metal negro black metal			
	<b>COMPLEMENTOS/COMPLEMENTS</b>				
MO_440P31	MOSS frentes . puerta madera bat iz 1h L64 H32 MOSS accessories . left hinged wooden door 1h W64 H32	eucalipto ahumado smoked eucalyptus	1	86	86
MO_410C21_2	MOSS frentes . jgo 2 cajones 1h L48 H32 tirador pomo negro MOSS accessories . set 2 drawers 1h W48 H32 knob black handle	eucalipto ahumado smoked eucalyptus	1	190	190
MO_530E41_t	MOSS accesorios . estante cristal L80 MOSS glass shelf W80 H0.6	transparente transparent	1	38	38
<b>TOTAL</b>					<b>1244</b>

# Moss 05

ref	descripción/description	acabado/finish	u	p/u	total
	<b>ESTRUCTURA/STRUCTURE</b>				
MO_210S21	MOSS v suspendida . aparador simétrico 1h L167,5 H35 F44 MOSS suspended v . symmetric sideboard 1h W167.5 H35 D44	laca mate matt lacquer	1	624	624
	acabado exterior outer finish	laca mate matt lacquer			
	acabado interior inner finish	laca mate matt lacquer			
	<b>COMPLEMENTOS/COMPLEMENTS</b>				
MO_410C41_1	MOSS frentes . jgo 2 cajones 1h L80 H32 tirador embutido negro MOSS accessories . set 2 drawers 1h W80 H32 inlay black handle	laca mate matt lacquer	2	204	408
OP_110	OPCIONAL . incremento metal lacado . tirador embutido OPTIONAL . lacquered metal increment . inlay handle	laca mate matt lacquer	4	10	40
			<b>TOTAL</b>	<b>1072</b>	

# Moss 06

ref	descripción/description	acabado/finish	u	p/u	total
	<b>ESTRUCTURA/STRUCTURE</b>				
MO_120A52	MOSS v patas metálicas . aparador asimétrico 2h L263,5 H85 F44 MOSS metal legs v . asymmetric sideboard 2h W263.5 H85 D44	nogal walnut	1	1442	1442
	acabado exterior outer finish	laca mate matt lacquer			
	acabado interior inner finish	laca mate matt lacquer			
	patas metálicas metal legs	metal negro black metal			
	<b>COMPLEMENTOS/COMPLEMENTS</b>				
MO_440P32	MOSS frentes . puerta madera bat iz 2h L64 H64 MOSS accessories . left hinged wooden door 2h W64 H64	nogal walnut	1	108	108
MO_441P32	MOSS frentes . puerta madera bat de 2h L64 H64 MOSS accessories . right hinged wooden door 2h W64 H64	nogal walnut	1	108	108
MO_410C21_0	MOSS frentes . jgo 2 cajones 1h L48 H32 sin tirador MOSS accessories . set 2 drawers 1h W48 H32	laca mate matt lacquer	2	162	324
			<b>TOTAL</b>	<b>1982</b>	

# Moss 07

ref	descripción/description	acabado/finish	u	p/u	total
	<b>ESTRUCTURA/STRUCTURE</b>				
MO_210S52	MOSS v suspendida . aparador simétrico 2h L263,5 H67 F44 MOSS suspended v . symmetric sideboard 2h W263.5 H67 D44		1	1290	1290
	acabado exterior outer finish	eucalipto ahumado smoked eucalyptus			
	acabado interior inner finish	laca mate matt lacquer			
	<b>COMPLEMENTOS/COMPLEMENTS</b>				
MO_520E30	MOSS accesorios . estante madera L64 H3,5 MOSS wooden shelf W64 H3,5	laca mate matt lacquer	-4	52	-208
MO_530E31	MOSS accesorios . estante cristal L64 MOSS glass shelf W64 H0.6	transparente transparent	4	34	136
MO_470P32	MOSS frentes . BET puerta cristal bat iz 2h L64 H64 MOSS accessories . BET left hinged glass door 2h W64 H64	metal negro / dark grey black metal / dark grey	2	298	596
MO_471P32	MOSS frentes . BET puerta cristal bat de 2h L64 H64 MOSS accessories . BET right hinged glass door 2h W64 H64	metal negro / dark grey black metal / dark grey	2	298	596
				<b>TOTAL</b>	<b>2410</b>
	<b>ILUMINACION (OPCIONAL) / LIGHTING (OPTION)</b>				
MO_560L3	MOSS accesorios . led estante sin interruptor L64 MOSS led shelf without switch W64		4	42	168
AC_52	ACCESORIOS . iluminación control remoto (interruptor sin cable) ACCESSORIES . remote control lighting (cordless switch)		1	68	68
AC_511	ACCESORIOS . iluminación transformador . 30w ACCESSORIES . transformer lighting . 30w		1	64	64

# Moss 08

ref	descripción/description	acabado/finish	u	p/u	total
	<b>ESTRUCTURA/STRUCTURE</b>				
MO_310S32	MOSS v zócalo . aparador simétrico 2h L199,5 H71 F44 MOSS plate base v . symmetric sideboard 2h W199.5 H71 D44		1	1044	1044
	acabado exterior outer finish	nogal walnut			
	acabado interior inner finish	laca mate matt lacquer			
	<b>COMPLEMENTOS/COMPLEMENTS</b>				
MO_520E30	MOSS accesorios . estante madera L64 H3,5 MOSS wooden shelf W64 H3,5	laca mate matt lacquer	-2	52	-104
MO_530E31	MOSS accesorios . estante cristal L64 MOSS glass shelf W64 H0.6	transparente transparent	2	34	68
MO_470P32	MOSS frentes . BET puerta cristal bat iz 2h L64 H64 MOSS accessories . BET left hinged glass door 2h W64 H64	metal negro / transparente black metal / transparent	1	288	288
MO_471P32	MOSS frentes . BET puerta cristal bat de 2h L64 H64 MOSS accessories . BET right hinged glass door 2h W64 H64	metal negro / transparente black metal / transparent	1	288	288
MO_410C31_2	MOSS frentes . jgo 2 cajones 1h L64 H32 tirador pomo negro MOSS accessories . set 2 drawers 1h W64 H32 knob black handle	nogal walnut	1	202	202
				<b>TOTAL</b>	<b>1786</b>
	<b>ILUMINACION (OPCIONAL) / LIGHTING (OPTION)</b>				
MO_560L3	MOSS accesorios . led estante sin interruptor L64 MOSS led shelf without switch W64		2	42	84
AC_52	ACCESORIOS . iluminación control remoto (interruptor sin cable) ACCESSORIES . remote control lighting (cordless switch)		1	68	68
AC_511	ACCESORIOS . iluminación transformador . 30w ACCESSORIES . transformer lighting . 30w		1	64	64



# Moss 09

ref	descripción/description	acabado/finish	u	p/u	total
	<b>ESTRUCTURA/STRUCTURE</b>				
MO_120A32	MOSS v patas metálicas . aparador asimétrico 2h L199,5 H85 F44 MOSS metal legs v . asymmetric sideboard 2h W199.5 H85 D44		1	1160	1160
	acabado exterior outer finish	laca mate matt lacquer			
	acabado interior inner finish	laca mate matt lacquer			
	patas metálicas metal legs	metal negro black metal			
OP_114	OPCIONAL . incremento metal lacado . estructura MOSS L199,5 OPTIONAL . lacquered metal increment . MOSS structure W199,5	laca mate matt lacquer	1	60	60
	<b>COMPLEMENTOS/COMPLEMENTS</b>				
MO_440P32	MOSS frentes . puerta madera bat iz 2h L64 H64 MOSS accessories . left hinged wooden door 2h W64 H64	laca mate matt lacquer	1	88	88
MO_442P22	MOSS frentes . jgo puertas madera bat 2h L80 H64 MOSS accessories . hinged wooden doors set 2h W80 H64	laca mate matt lacquer	1	146	146
MO_441P22	MOSS frentes . puerta madera bat de 2h L48 H64 MOSS accessories . right hinged wooden door 2h W48 H64	laca mate matt lacquer	1	78	78
<b>TOTAL</b>					<b>1532</b>

# Moss 10

ref	descripción/description	acabado/finish	u	p/u	total
	<b>ESTRUCTURA/STRUCTURE</b>				
MO_120A12	MOSS v patas metálicas . aparador asimétrico 2h L135,5 H85 F44 MOSS metal legs v . asymmetric sideboard 2h W135.5 H85 D44		1	928	928
	acabado exterior outer finish	roble oak			
	acabado interior inner finish	laca mate matt lacquer			
	patas metálicas metal legs	metal negro black metal			
	<b>COMPLEMENTOS/COMPLEMENTS</b>				
MO_420P41	MOSS frentes . puerta madera aba 1h L80 H32 MOSS accessories . bottom hung wooden door 1h W80 H32	roble oak	1	136	136
MO_410C21_1	MOSS frentes . jgo 2 cajones 1h L48 H32 tirador embutido negro MOSS accessories . set 2 drawers 1h W48 H32 inlay black handle	laca mate matt lacquer	1	178	178
<b>TOTAL</b>					<b>1242</b>

# Moss 11

ref	descripción/description	acabado/finish	u	p/u	total
<b>ESTRUCTURA/STRUCTURE</b>					
MO_220A53	MOSS v suspendida . aparador asimétrico 3h L263,5 H99 F44 MOSS suspended v . asymmetric sideboard 3h W263.5 H99 D44		1	1578	1578
	acabado exterior outer finish	laca mate matt lacquer			
	acabado interior inner finish	laca mate matt lacquer			
<b>COMPLEMENTOS/COMPLEMENTS</b>					
MO_520E30	MOSS accesorios . estante madera L64 H3,5 MOSS wooden shelf W64 H3,5	laca mate matt lacquer	-4	52	-208
MO_530E31	MOSS accesorios . estante cristal L64 MOSS glass shelf W64 H0.6	transparente transparent	4	34	136
MO_470P33	MOSS frentes . BET puerta cristal bat iz 3h L64 H96 MOSS accessories . BET left hinged glass door 3h W64 H96	metal negro / transparente black metal / transparent	1	310	310
MO_471P33	MOSS frentes . BET puerta cristal bat de 3h L64 H96 MOSS accessories . BET right hinged glass door 3h W64 H96	metal negro / transparente black metal / transparent	1	310	310
MO_441P23	MOSS frentes . puerta madera bat de 3h L48 H96 MOSS accessories . right hinged wooden door 3h W48 H96	roble oak	1	122	122
			<b>TOTAL</b>	<b>2248</b>	
<b>ILUMINACION (OPCIONAL) / LIGHTING (OPTION)</b>					
MO_560L3	MOSS accesorios . led estante sin interruptor L64 MOSS led shelf without switch W64		2	42	84
AC_52	ACCESORIOS . iluminación control remoto (interruptor sin cable) ACCESSORIES . remote control lighting (cordless switch)		1	68	68
AC_511	ACCESORIOS . iluminación transformador . 30w ACCESSORIES . transformer lighting . 30w		1	64	64

# Moss 12

ref	descripción/description	acabado/finish	u	p/u	total
<b>ESTRUCTURA/STRUCTURE</b>					
MO_110S23	MOSS v patas metálicas . aparador simétrico 3h L167,5 H117 F44 MOSS metal legs v . symmetric sideboards 3h W167.5 H117 D44		1	1246	1246
	acabado exterior outer finish	eucalipto ahumado smoked eucalyptus			
	acabado interior inner finish	laca mate matt lacquer			
	patas metálicas metal legs	metal negro black metal			
<b>COMPLEMENTOS/COMPLEMENTS</b>					
MO_410C41_2	MOSS frentes . jgo 2 cajones 1h L80 H32 tirador pomo negro MOSS accessories . set 2 drawers 1h W80 H32 knob black handle	eucalipto ahumado smoked eucalyptus	1	226	226
MO_442P22	MOSS frentes . jgo puertas madera bat 2h L80 H64 MOSS accessories . hinged wooden doors set 2h W80 H64	eucalipto ahumado smoked eucalyptus	1	186	186
			<b>TOTAL</b>	<b>1658</b>	

# Moss 13

ref	descripción/description	acabado/finish	u	p/u	total
<b>MO_320A13</b>	<b>ESTRUCTURA/STRUCTURE</b> MOSS v zócalo . aparador asimétrico 3h L135,5 H103 F44 MOSS plate base v . asymmetric sideboard 3h W135.5 H103 D44		1	920	920
	acabado exterior outer finish	laca mate matt lacquer			
	acabado interior inner finish	laca mate matt lacquer			
<b>MO_520E40</b>	<b>COMPLEMENTOS/COMPLEMENTS</b> MOSS accesorios . estante madera L80 H3,5 MOSS wooden shelf W80 H3,5	laca mate matt lacquer	-2	58	-116
<b>MO_530E41</b>	MOSS accesorios . estante cristal L80 MOSS glass shelf W80 H0.6	transparente transparent	2	38	76
<b>MO_472P43</b>	MOSS frentes . BET jgo puertas cristal bat 3h L80 H96 MOSS accessories . BET hinged glass doors set 3h W80 H96	metal negro / transparente black metal / transparent	1	558	558
			<b>TOTAL</b>	<b>1438</b>	

<b>MO_560L4</b>	<b>ILUMINACION (OPCIONAL) / LIGHTING (OPTION)</b> MOSS accesorios . led estante sin interruptor L80 MOSS led shelf without switch W80		1	46	46
<b>AC_52</b>	ACCESORIOS . iluminación control remoto (interruptor sin cable) ACCESSORIES . remote control lighting (cordless switch)		1	68	68
<b>AC_511</b>	ACCESORIOS . iluminación transformador . 30w ACCESSORIES . transformer lighting . 30w		1	64	64

ref	descripción/description	acabado/finish	u	p/u	total
<b>MO_320A13</b>	<b>ESTRUCTURA/STRUCTURE</b> MOSS v zócalo . aparador asimétrico 3h L135,5 H103 F44 MOSS plate base v . asymmetric sideboard 3h W135.5 H103 D44		1	920	920
	acabado exterior outer finish	laca mate matt lacquer			
	acabado interior inner finish	laca mate matt lacquer			
<b>MO_410C41</b>	<b>COMPLEMENTOS/COMPLEMENTS</b> MOSS frentes . jgo 2 cajones 1h L80 H32 tirador embutido negro MOSS accessories . set 2 drawers 1h W80 H32 inlay black handle	laca mate matt lacquer	1	204	204
<b>MO_441P23</b>	MOSS frentes . puerta madera bat de 3h L48 H96 MOSS accessories . right hinged wooden door 3h W48 H96	laca mate matt lacquer	1	98	98
			<b>TOTAL</b>	<b>1222</b>	

# Moss 14

ref	descripción/description	acabado/finish	u	p/u	total
<b>MO_210S54</b>	<b>ESTRUCTURA/STRUCTURE</b> MOSS v suspendida . aparador simétrico 4h L263,5 H131 F44 MOSS suspended v . symmetric sideboard 4h W263.5 H131 D44		1	1936	1936
	acabado exterior outer finish	laca mate matt lacquer			
	acabado interior inner finish	laca mate matt lacquer			
<b>MO_520E30</b>	<b>COMPLEMENTOS/COMPLEMENTS</b> MOSS accesorios . estante madera L64 H3,5 MOSS wooden shelf W64 H3,5	laca mate matt lacquer	-8	52	-416
<b>MO_530E31</b>	MOSS accesorios . estante cristal L64 MOSS glass shelf W64 H0.6	transparente transparent	8	34	272
<b>MO_470P32</b>	MOSS frentes . BET puerta cristal bat iz 2h L64 H64 MOSS accessories . BET left hinged glass door 2h W64 H64	metal negro / transparente black metal / transparent	4	288	1152
<b>MO_471P32</b>	MOSS frentes . BET puerta cristal bat de 2h L64 H64 MOSS accessories . BET right hinged glass door 2h W64 H64	metal negro / transparente black metal / transparent	4	288	1152
			<b>TOTAL</b>	<b>4096</b>	

<b>MO_560L3</b>	<b>ILUMINACION (OPCIONAL) / LIGHTING (OPTION)</b> MOSS accesorios . led estante sin interruptor L64 MOSS led shelf without switch W64		8	42	336
<b>AC_52</b>	ACCESORIOS . iluminación control remoto (interruptor sin cable) ACCESSORIES . remote control lighting (cordless switch)		2	68	136
<b>AC_511</b>	ACCESORIOS . iluminación transformador . 30w ACCESSORIES . transformer lighting . 30w		2	64	128

# Moss 15

ref	descripción/description	acabado/finish	u	p/u	total
	<b>ESTRUCTURA/STRUCTURE</b>				
MO_310S34	MOSS v zócalo . aparador simétrico 4h L199,5 H135 F44 MOSS plate base v . symmetric sideboard 4h W199.5 H135 D44		1	1592	1592
	acabado exterior outer finish	eucalipto ahumado smoked eucalyptus			
	acabado interior inner finish	laca mate matt lacquer			
	<b>COMPLEMENTOS/COMPLEMENTS</b>				
MO_410C31	MOSS frentes . jgo 2 cajones 1h L64 H32 tirador embutido negro MOSS accessories . set 2 drawers 1h W64 H32 inlay black handle	laca mate matt lacquer	2	192	384
<b>TOTAL</b>					<b>1976</b>

# Moss 16

ref	descripción/description	acabado/finish	u	p/u	total
	<b>ESTRUCTURA/STRUCTURE</b>				
MO_310S14	MOSS v zócalo . aparador simétrico 4h L135,5 H135 F44 MOSS plate base v . symmetric sideboard 4h W135.5 H135 D44		1	1172	928
	acabado exterior outer finish	roble oak			
	acabado interior inner finish	laca mate matt lacquer			
	<b>COMPLEMENTOS/COMPLEMENTS</b>				
MO_440P32	MOSS frentes . puerta madera bat iz 2h L64 H64 MOSS accessories . left hinged wooden door 2h W64 H64	roble oak	1	108	108
MO_441P32	MOSS frentes . puerta madera bat de 2h L64 H64 MOSS accessories . right hinged wooden door 2h W64 H64	roble oak	1	108	108
MO_410C31_1	MOSS frentes . jgo 2 cajones 1h L64 H32 tirador embutido negro MOSS accessories . set 2 drawers 1h W64 H32 inlay black handle	laca mate matt lacquer	1	192	192
<b>TOTAL</b>					<b>1580</b>

# Yoko 01

ref	descripción/description	acabado/finish	u	p/u	total
YO_11M351	<b>ESTRUCTURA/STRUCTURE</b> YOKO estructura . a suelo L90 H184 F32 YOKO structure to floor . W90 H184 D32	laca mate matt lacquer	4	544	2176
YO_11M251	YOKO estructura . a suelo L61 H184 F32 YOKO structure to floor . W61 H184 D32	laca mate matt lacquer	2	454	908
YO_21S111	YOKO separador . recto L1,2 H35 F31 YOKO straight divider . W1.2 H35 D31	laca mate matt lacquer	20	36	720
YO_22S111	YOKO separador . forma L1,2 H36 F31 YOKO form divider . W1.2 H36 D31	laca mate matt lacquer	18	36	648
YO_24S111	YOKO separador . recto tv L1,2 H17,5 F31 YOKO tv straight divider . W1.2 H17,5 D31	laca mate matt lacquer	4	32	128
YO_25S111	YOKO separador . recto escritorio L1,2 H33 F31 YOKO desk straight divider . W1.2 H33 D31	laca mate matt lacquer	2	36	72
YO_31C111	<b>COMPLEMENTOS/COMPLEMENTS</b> YOKO contenedor . abierto L13 H35 F35 YOKO open container . W13 H35 D35	laca mate matt lacquer	3	108	324
YO_32C211	YOKO contenedor . puerta madera batiente L28 H35 F35 YOKO hinged door container . W28 H35 D35	roble oak	2	210	420
YO_33C611	YOKO contenedor . puerta madera abatible L86 H35 F35 YOKO bottom hung door container . W86 H35 D35	roble oak	1	366	366
YO_34C612	YOKO contenedor . cajones L86 H35 F40 . roble YOKO drawers container . W86 H35 D40 . oak	roble oak	1	392	392
YO_35C616	YOKO contenedor . tv cajones (para 2 módulos L90) L176 H17,5 F60 YOKO tv drawers container (for 2 modules W90) . W176 H17,5 D60	laca mate matt lacquer	1	494	494
YO_42E414	YOKO estante escritorio . L118 H2 F50 (para 2 módulos L61) YOKO desk shelf (for 2 modules W61) . W118 H2 D50	laca mate matt lacquer	1	88	88
<b>TOTAL</b>					<b>6736</b>

# Yoko 02

ref	descripción/description	acabado/finish	u	p/u	total
YO_11M351	<b>ESTRUCTURA/STRUCTURE</b> YOKO estructura . a suelo L90 H184 F32 YOKO structure to floor . W90 H184 D32	laca mate matt lacquer	5	544	2720
YO_21S111	YOKO separador . recto L1,2 H35 F31 YOKO straight divider . W1.2 H35 D31	laca mate matt lacquer	19	36	684
YO_22S111	YOKO separador . forma L1,2 H36 F31 YOKO form divider . W1.2 H36 D31	laca mate matt lacquer	18	36	648
YO_24S111	YOKO separador . recto tv L1,2 H17,5 F31 YOKO tv straight divider . W1.2 H17,5 D31	laca mate matt lacquer	4	32	128
YO_31C111	<b>COMPLEMENTOS/COMPLEMENTS</b> YOKO contenedor . abierto L13 H35 F35 YOKO open container . W13 H35 D35	laca mate matt lacquer	3	108	324
YO_32C411	YOKO contenedor . puerta madera batiente L57 H35 F35 YOKO hinged door container . W57 H35 D35	roble oak	1	268	268
YO_33C611	YOKO contenedor . puerta madera abatible L86 H35 F35 YOKO bottom hung door container . W86 H35 D35	roble oak	1	366	366
YO_34C412	YOKO contenedor . cajones L57 H35 F40 YOKO drawers container . W57 H35 D40	roble oak	1	330	330
YO_35C616	YOKO contenedor . tv cajones (para 2 módulos L90) L176 H17,5 F60 YOKO tv drawers container (for 2 modules W90) . W176 H17,5 D60	roble oak	1	660	660
YO_36C311	YOKO contenedor . cristal L42 H35 F35 YOKO glass container . W42 H35 D35	transparente transparent	2	260	520
<b>TOTAL</b>					<b>6648</b>

# Yoko 03

ref	descripción/description	acabado/finish	u	p/u	total
YO_11M351	<b>ESTRUCTURA/STRUCTURE</b> YOKO estructura . a suelo L90 H184 F32 YOKO structure to floor . W90 H184 D32	laca mate matt lacquer	3	544	1632
YO_11M251	YOKO estructura . a suelo L61 H184 F32 YOKO structure to floor . W61 H184 D32	laca mate matt lacquer	2	454	908
YO_21S111	YOKO separador . recto L1,2 H35 F31 YOKO straight divider . W1.2 H35 D31	laca mate matt lacquer	14	36	504
YO_22S111	YOKO separador . forma L1,2 H36 F31 YOKO form divider . W1.2 H36 D31	laca mate matt lacquer	16	36	576
YO_24S111	YOKO separador . recto tv L1,2 H17,5 F31 YOKO tv straight divider . W1.2 H17,5 D31	laca mate matt lacquer	4	32	128
YO_25S111	YOKO separador . recto escritorio L1,2 H33 F31 YOKO desk straight divider . W1.2 H33 D31	laca mate matt lacquer	2	36	72
YO_31C111	<b>COMPLEMENTOS/COMPLEMENTS</b> YOKO contenedor . abierto L13 H35 F35 YOKO open container . W13 H35 D35	laca mate matt lacquer	3	108	324
YO_32C211	YOKO contenedor . puerta madera batiente L28 H35 F35 YOKO hinged door container . W28 H35 D35	eucalipto ahumado smoked eucalyptus	1	240	240
YO_32C411	YOKO contenedor . puerta madera batiente L57 H35 F35 YOKO hinged door container . W57 H35 D35	eucalipto ahumado smoked eucalyptus	1	308	308
YO_34C412	YOKO contenedor . cajones L57 H35 F40 YOKO drawers container . W57 H35 D40	eucalipto ahumado smoked eucalyptus	1	368	368
YO_35C616	YOKO contenedor . tv cajones (para 2 módulos L90) L176 H17,5 F60 YOKO tv drawers container (for 2 modules W90) . W176 H17,5 D60	eucalipto ahumado smoked eucalyptus	1	778	778
YO_41E614	YOKO estante escritorio . L86 H2 F50 (para módulo L90) YOKO desk shelf (for module W90) . W86 H2 D50	laca mate matt lacquer	1	74	74
<b>TOTAL</b>					<b>5912</b>

# Yoko 04

ref	descripción/description	acabado/finish	u	p/u	total
YO_11M351	<b>ESTRUCTURA/STRUCTURE</b> YOKO estructura . a suelo L90 H184 F32 YOKO structure to floor . W90 H184 D32	laca mate matt lacquer	4	544	2176
YO_21S111	YOKO separador . recto L1,2 H35 F31 YOKO straight divider . W1.2 H35 D31	laca mate matt lacquer	16	36	576
YO_22S111	YOKO separador . forma L1,2 H36 F31 YOKO form divider . W1.2 H36 D31	laca mate matt lacquer	16	36	576
YO_24S111	YOKO separador . recto tv L1,2 H17,5 F31 YOKO tv straight divider . W1.2 H17,5 D31	laca mate matt lacquer	4	32	128
YO_31C111	<b>COMPLEMENTOS/COMPLEMENTS</b> YOKO contenedor . abierto L13 H35 F35 YOKO open container . W13 H35 D35	laca mate matt lacquer	2	108	216
YO_32C211	YOKO contenedor . puerta madera batiente L28 H35 F35 YOKO hinged door container . W28 H35 D35	nogal walnut	1	210	210
YO_32C411	YOKO contenedor . puerta madera batiente L57 H35 F35 YOKO hinged door container . W57 H35 D35	nogal walnut	1	268	268
YO_34C412	YOKO contenedor . cajones L57 H35 F40 YOKO drawers container . W57 H35 D40	nogal walnut	1	330	330
YO_35C616	YOKO contenedor . tv cajones (para 2 módulos L90) L176 H17,5 F60 YOKO tv drawers container (for 2 modules W90) . W176 H17,5 D60	nogal walnut	1	660	660
YO_36C411	YOKO contenedor . cristal L57 H35 F35 YOKO glass container . W57 H35 D35	transparente transparent	2	280	560
<b>TOTAL</b>					<b>5700</b>

# Yoko 05

ref	descripción/description	acabado/finish	u	p/u	total
YO_11M351	<b>ESTRUCTURA/STRUCTURE</b> YOKO estructura . a suelo L90 H184 F32 YOKO structure to floor . W90 H184 D32	laca mate matt lacquer	3	544	1632
YO_11M251	YOKO estructura . a suelo L61 H184 F32 YOKO structure to floor . W61 H184 D32	laca mate matt lacquer	1	454	454
YO_21S111	YOKO separador . recto L1,2 H35 F31 YOKO straight divider . W1.2 H35 D31	laca mate matt lacquer	12	36	432
YO_22S111	YOKO separador . forma L1,2 H36 F31 YOKO form divider . W1.2 H36 D31	laca mate matt lacquer	14	36	504
YO_24S111	YOKO separador . recto tv L1,2 H17,5 F31 YOKO tv straight divider . W1.2 H17,5 D31	laca mate matt lacquer	4	32	128
YO_25S111	YOKO separador . recto escritorio L1,2 H33 F31 YOKO desk straight divider . W1.2 H33 D31	laca mate matt lacquer	2	36	72
YO_31C111	<b>COMPLEMENTOS/COMPLEMENTS</b> YOKO contenedor . abierto L13 H35 F35 YOKO open container . W13 H35 D35	laca mate matt lacquer	2	108	216
YO_32C211	YOKO contenedor . puerta madera batiente L28 H35 F35 YOKO hinged door container . W28 H35 D35	laca mate matt lacquer	1	174	174
YO_32C311	YOKO contenedor . puerta madera batiente L42 H35 F35 YOKO hinged door container . W42 H35 D35	roble oak	1	242	242
YO_35C616	YOKO contenedor . tv cajones (para 2 módulos L90) L176 H17,5 F60 YOKO tv drawers container (for 2 modules W90) . W176 H17,5 D60	roble oak	1	660	660
YO_41E614	YOKO estante escritorio . L86 H2 F50 (para módulo L90) YOKO desk shelf (for module W90) . W86 H2 D50	roble oak	1	92	92
			<b>TOTAL</b>	<b>4606</b>	

# Yoko 06

LOYRATIME 1701171

ref	descripción/description	acabado/finish	u	p/u	total
YO_11M251	<b>ESTRUCTURA/STRUCTURE</b> YOKO estructura . a suelo L61 H184 F32 YOKO structure to floor . W61 H184 D32	laca mate matt lacquer	2	454	908
YO_11M351	YOKO estructura . a suelo L90 H184 F32 YOKO structure to floor . W90 H184 D32	laca mate matt lacquer	2	544	1088
YO_21S111	YOKO separador . recto L1,2 H35 F31 YOKO straight divider . W1.2 H35 D31	laca mate matt lacquer	10	36	360
YO_22S111	YOKO separador . forma L1,2 H36 F31 YOKO form divider . W1.2 H36 D31	laca mate matt lacquer	10	36	360
YO_24S111	YOKO separador . recto tv L1,2 H17,5 F31 YOKO tv straight divider . W1.2 H17,5 D31	laca mate matt lacquer	4	32	128
YO_32C411	<b>COMPLEMENTOS/COMPLEMENTS</b> YOKO contenedor . puerta madera batiente L57 H35 F35 YOKO hinged door container . W57 H35 D35	roble oak	5	268	1340
YO_35C616	YOKO contenedor . tv cajones (para 2 módulos L90) L176 H17,5 F60 YOKO tv drawers container (for 2 modules W90) . W176 H17,5 D60	laca mate matt lacquer	1	494	494
			<b>TOTAL</b>	<b>4678</b>	

# Yoko 07

ref	descripción/description	acabado/finish	u	p/u	total
YO_11M351	<b>ESTRUCTURA/STRUCTURE</b> YOKO estructura . a suelo L90 H184 F32 YOKO structure to floor . W90 H184 D32	laca mate matt lacquer	3	544	1632
YO_21S111	YOKO separador . recto L1,2 H35 F31 YOKO straight divider . W1.2 H35 D31	laca mate matt lacquer	13	36	468
YO_22S111	YOKO separador . forma L1,2 H36 F31 YOKO form divider . W1.2 H36 D31	laca mate matt lacquer	11	36	396
YO_25S111	YOKO separador . recto escritorio L1,2 H33 F31 YOKO desk straight divider . W1.2 H33 D31	laca mate matt lacquer	2	36	72
YO_31C111	<b>COMPLEMENTOS/COMPLEMENTS</b> YOKO contenedor . abierto L13 H35 F35 YOKO open container . W13 H35 D35	laca mate matt lacquer	2	108	216
YO_34C612	YOKO contenedor . cajones L86 H35 F40 YOKO drawers container . W86 H35 D40	roble oak	1	392	392
YO_36C311	YOKO contenedor . cristal L42 H35 F35 YOKO glass container . W42 H35 D35	transparente transparent	1	260	260
YO_42E614	YOKO estante escritorio . L176 H2 F50 (para 2 módulos L90) YOKO desk shelf (for 2 modules W90) . W176 H2 D50	laca mate matt lacquer	1	112	112
<b>TOTAL</b>					<b>3548</b>

# Yoko 08

LOYRATIME 1721173

ref	descripción/description	acabado/finish	u	p/u	total
YO_11M351	<b>ESTRUCTURA/STRUCTURE</b> YOKO estructura . a suelo L90 H184 F32 YOKO structure to floor . W90 H184 D32	laca mate matt lacquer	2	544	1088
YO_21S111	YOKO separador . recto L1,2 H35 F31 YOKO straight divider . W1.2 H35 D31	laca mate matt lacquer	6	36	216
YO_22S111	YOKO separador . forma L1,2 H36 F31 YOKO form divider . W1.2 H36 D31	laca mate matt lacquer	8	36	288
YO_24S111	YOKO separador . recto tv L1,2 H17,5 F31 YOKO tv straight divider . W1.2 H17,5 D31	laca mate matt lacquer	4	32	128
YO_31C111	<b>COMPLEMENTOS/COMPLEMENTS</b> YOKO contenedor . abierto L13 H35 F35 YOKO open container . W13 H35 D35	laca mate matt lacquer	2	108	216
YO_35C616	YOKO contenedor . tv cajones (para 2 módulos L90) L176 H17,5 F60 YOKO tv drawers container (for 2 modules W90) . W176 H17,5 D60	eucalipto ahumado smoked eucalyptus	1	778	778
<b>TOTAL</b>					<b>2714</b>

ref	descripción/description	acabado/finish	u	p/u	total
YO_11M351	<b>ESTRUCTURA/STRUCTURE</b> YOKO estructura . a suelo L90 H184 F32 YOKO structure to floor . W90 H184 D32	laca mate matt lacquer	1	544	544
YO_21S111	YOKO separador . recto L1,2 H35 F31 YOKO straight divider . W1.2 H35 D31	laca mate matt lacquer	4	36	144
YO_22S111	YOKO separador . forma L1,2 H36 F31 YOKO form divider . W1.2 H36 D31	laca mate matt lacquer	4	36	144
YO_25S111	YOKO separador . recto escritorio L1,2 H33 F31 YOKO desk straight divider . W1.2 H33 D31	laca mate matt lacquer	2	36	72
YO_32C211	<b>COMPLEMENTOS/COMPLEMENTS</b> YOKO contenedor . puerta madera batiente L28 H35 F35 YOKO hinged door container . W28 H35 D35	eucalipto ahumado smoked eucalyptus	1	240	240
YO_41E614	YOKO estante escritorio . L86 H2 F50 (para módulo L90) YOKO desk shelf (for module W90) . W86 H2 D50	eucalipto ahumado smoked eucalyptus	1	106	106
<b>TOTAL</b>					<b>1250</b>



# Yoko 09

ref	descripción/description	acabado/finish	u	p/u	total
	<b>ESTRUCTURA/STRUCTURE</b>				
YO_12M521	YOKO estructura . suspendida con patas L149 H95 F32 metal negro YOKO structure suspended with legs . W149 H95 D32	laca mate matt lacquer	1	470	470
YO_22S111	YOKO separador . forma L1,2 H36 F31 YOKO form divider . W1.2 H36 D31	laca mate matt lacquer	6	36	216
	<b>COMPLEMENTOS/COMPLEMENTS</b>				
YO_34C512	YOKO contenedor . cajones L72 H35 F40 YOKO drawers container . W72 H35 D40	roble oak	1	360	360
YO_32C311	YOKO contenedor . puerta madera batiente L42 H35 F35 YOKO hinged door container . W42 H35 D35	laca mate matt lacquer	1	184	184
YO_36C311	YOKO contenedor . cristal L42 H35 F35 YOKO glass container . W42 H35 D35	transparente transparent	1	260	260
			<b>TOTAL</b>	<b>1490</b>	

# Yoko 10

LOYRATIME 174 I 175

ref	descripción/description	acabado/finish	u	p/u	total
	<b>ESTRUCTURA/STRUCTURE</b>				
YO_11M721	YOKO estructura . a suelo L207 H76 F32 YOKO structure to floor . W207 H76 D32	laca mate matt lacquer	1	478	478
YO_22S111	YOKO separador . forma L1,2 H36 F31 YOKO form divider . W1.2 H36 D31	laca mate matt lacquer	10	36	360
	<b>COMPLEMENTOS/COMPLEMENTS</b>				
YO_31C111	YOKO contenedor . abierto L13 H35 F35 YOKO open container . W13 H35 D35	laca mate matt lacquer	2	108	216
YO_32C311	YOKO contenedor . puerta madera batiente L42 H35 F35 YOKO hinged door container . W42 H35 D35	laca mate matt lacquer	2	184	368
YO_34C612	YOKO contenedor . cajones L86 H35 F40 YOKO drawers container . W86 H35 D40	oak roble	1	392	392
			<b>TOTAL</b>	<b>1814</b>	

# Yoko 11

ref	descripción/description	acabado/finish	u	p/u	total
YO_12M711	<b>ESTRUCTURA/STRUCTURE</b> YOKO estructura . suspendida con patas L207 H59 F32 metal negro YOKO structure suspended with legs . W207 H59 D32	laca mate matt lacquer	1	418	418
YO_23S111	YOKO separador . forma doble L1,2 H37 F31 YOKO double form divider . W1.2 H37 D31	laca mate matt lacquer	5	36	180
YO_31C111	<b>COMPLEMENTOS/COMPLEMENTS</b> YOKO contenedor . abierto L13 H35 F35 YOKO open container . W13 H35 D35	laca mate matt lacquer	1	108	108
YO_34C512	YOKO contenedor . cajones L72 H35 F40 YOKO drawers container . W72 H35 D40	eucalipto ahumado smoked eucalyptus	1	406	406
YO_36C411	YOKO contenedor . cristal L57 H35 F35 YOKO glass container . W57 H35 D35	transparente transparent	1	280	280
<b>TOTAL</b>					<b>1392</b>

# Yoko 12

ref	descripción/description	acabado/finish	u	p/u	total
YO_11M511	<b>ESTRUCTURA/STRUCTURE</b> YOKO estructura . a suelo L149 H40 F32 YOKO structure to floor . W149 H40 D32	laca mate matt lacquer	1	272	272
YO_23S111	YOKO separador . forma doble L1,2 H37 F31 YOKO double form divider . W1.2 H37 D31	laca mate matt lacquer	5	36	180
YO_32C311	<b>COMPLEMENTOS/COMPLEMENTS</b> YOKO contenedor . puerta madera batiente L42 H35 F35 YOKO hinged door container . W42 H35 D35	roble oak	1	242	242
YO_32C211	YOKO contenedor . puerta madera batiente L28 H35 F35 YOKO hinged door container . W28 H35 D35	laca mate matt lacquer	1	174	174
<b>TOTAL</b>					<b>868</b>

ref	descripción/description	acabado/finish	nº	pv	total
YO_11M511	<b>ESTRUCTURA/STRUCTURE</b> YOKO estructura . a suelo L149 H40 F32 YOKO structure to floor . W149 H40 D32	laca mate matt lacquer	1	272	272
YO_23S111	YOKO separador . forma doble L1,2 H37 F31 YOKO double form divider . W1.2 H37 D31	laca mate matt lacquer	4	36	144
YO_31C111	<b>COMPLEMENTOS/COMPLEMENTS</b> YOKO contenedor . abierto L13 H35 F35 YOKO open container . W13 H35 D35	laca mate matt lacquer	1	108	108
YO_34C512	YOKO contenedor . cajones L72 H35 F40 YOKO drawers container . W72 H35 D40	roble oak	1	360	360
<b>TOTAL</b>					<b>884</b>

# Q 01

ref	descripción/description	acabado/finish	u	p/u	total
<b>ESTRUCTURA/STRUCTURE</b>					
Q2_S3131	Q2 contenedor suspendido . puerta madera abatible v1 L80 H35 F35 Q2 suspended container . bottom hung wooden door v1 W80 H35 D35	eucalipto ahumado smoked eucalyptus	1	396	396
Q1_S1111	Q1 contenedor suspendido . abierto v1 L35 H35 F30 Q1 suspended container . open v1 W35 H35 D30	laca mate matt lacquer	1	170	170
Q1_S1111	Q1 contenedor suspendido . abierto v1 L35 H35 F35 Q1 suspended container . open v1 W35 H35 D35	laca mate matt lacquer	1	170	170
Q1_S1111	Q1 contenedor suspendido . abierto v1 L35 H35 F30 Q1 suspended container . open v1 W35 H35 D30	laca mate matt lacquer	1	170	170
Q2_S3121	Q2 contenedor suspendido . puerta madera abatible v1 L60 H35 F35 Q2 suspended container . bottom hung wooden door v1 W60 H35 D35	eucalipto ahumado eucalypto ahumado	1	368	368
Q2_S2212	Q2 contenedor suspendido . puerta madera batiente v2 L35 H70 F30 Q2 suspended container . hinged wooden door v2 W35 H70 D30	nogal walnut	1	348	348
Q1_S1121	Q1 contenedor suspendido . abierto v1 L60 H35 F35 Q1 suspended container . open v1 W60 H35 D35	laca mate matt lacquer	1	184	184
			<b>TOTAL 1806</b>		
BR_13	BRICH bancada tv . 280x45 H35	metal negro eucalipto ahumado tapa porcelánico duomo	1	980	980
	BRICH tv bench . 280x45 H35	black metal smoked eucalyptus porcelain top duomo			
			<b>TOTAL 2786</b>		

# Q 02

LOYRATIME 1781179

ref	descripción/description	acabado/finish	u	p/u	total
Q2_S2121	Q2 contenedor suspendido . puerta madera batiente v1 L50 H40 F30 Q2 suspended container . hinged wooden door v1 W50 H40 D30	laca mate matt lacquer	1	222	222
Q2_S2122	Q2 contenedor suspendido . puerta madera batiente v1 L50 H45 F35 Q2 suspended container . hinged wooden door v1 W50 H45 D35	laca mate matt lacquer	1	228	228
Q1_S1121	Q1 contenedor suspendido . abierto v1 L60 H35 F30 Q1 suspended container . open v1 W60 H35 D30	laca mate matt lacquer	1	184	184
Q1_S1112	Q1 contenedor suspendido . abierto v1 L40 H50 F40 Q1 suspended container . open v1 W40 H50 D40	laca mate matt lacquer	1	180	180
Q2_S2121	Q2 contenedor suspendido . puerta madera batiente v1 L50 H35 F35 Q2 suspended container . hinged wooden door v1 W50 H35 D35	laca mate matt lacquer	1	222	222
			<b>TOTAL 1036</b>		
<b>ESTRUCTURA/STRUCTURE</b>					
IS_110S112	IOS v a suelo . separador 1h L3,5 H39,5 F42 IOS floor v . divider 1h W3,5 H39,5 D42	roble oak	5	78	390
IS_120M512	IOS v a suelo . m librería 1h L96 H39,5 F42 IOS floor v . bookcase module 1h W96 H39,5 D42	roble oak	4	214	856
<b>COMPLEMENTOS/COMPLEMENTS</b>					
IS_440E012	IOS e comunes . encimera cml H1,3 F42 L401,5 IOS common elements . top cover cml H1,3 D42 W401,5	laca mate matt lacquer	1	240,9	240,9
IS_510C512_1	IOS f interiores . IN jgo 2 cajones 1h L96 H32 F42 tirador embutido negro IOS inner fronts . IN set 2 drawers 1h W96 H32 D42 inlay black handle	laca mate matt lacquer	1	216	216
IS_710P51	IOS f correderos . PLAY puerta madera 1h L99 H35 IOS sliding fronts . PLAY wooden door 1h W99 H35	laca mate matt lacquer	2	132	264
AC_21	ACCESORIOS . guia corredera PLAY aluminio negro . tapeta roble L399,5 ACCESSORIES . PLAY black aluminum sliding guide . oak front cover W399,5	tapeta roble oak front cover	2	239,7	479,4
			<b>TOTAL 2446</b>		
			<b>TOTAL 3482</b>		

# Q 03

ref	descripción/description	acabado/finish	u	p/u	total
Q3_S2121	Q3 contenedor suspendido . puerta madera batiente v1 L50 H35 F35 Q3 suspended container . hinged wooden door v1 W50 H35 D35	laca mate / laca mate matt lacquer / matt lacquer	3	260	780
Q1_S1141	Q1 contenedor suspendido . abierto v1 L100 H30 F40 Q1 suspended container . open v1 W100 H30 D40	laca mate matt lacquer	1	216	216
Q3_S5121	Q3 contenedor suspendido . puerta cristal batiente v1 L50 H35 F35  Q3 suspended container . hinged glass door v1 W50 H35 D35	laca mate metal negro transparente  matt lacquer black metal transparent	3	392	1176
<b>TOTAL</b>					<b>2172</b>
BR_13	BRICH bancada tv . 280x45 H35  BRICH tv bench . 280x45 H35	metal negro roble tapa porcelánico duomo  black metal oak porcelain top duomo	1	980	980
<b>TOTAL</b>					<b>3152</b>

# Q 04

ref	descripción/description	acabado/finish	u	p/u	total
Q2_S2111	Q2 contenedor suspendido . puerta madera batiente v1 L40 H35 F35 Q2 suspended container . hinged wooden door v1 W40 H35 D35	laca mate matt lacquer	4	214	856
Q1_S1151	Q1 contenedor suspendido . abierto v1 L120 H30 F30 Q1 suspended container . open v1 W120 H30 D30	nogal walnut	1	338	338
<b>TOTAL</b>					<b>1194</b>
<b>ESTRUCTURA/STRUCTURE</b>					
MO_220A51	MOSS v suspendida . aparador asimétrico 1h L263,5 H35 F44 MOSS suspended v . asymmetric sideboard 1h W263.5 H35 D44		1	952	952
	acabado exterior outer finish	eucalipto ahumado smoked eucalyptus			
	acabado interior inner finish	laca mate matt lacquer			
<b>COMPLEMENTOS/COMPLEMENTS</b>					
MO_410C31_1	MOSS frentes . jgo 2 cajones 1h L64 H32 tirador embutido negro MOSS accessories . set 2 drawers 1h W64 H32 inlay black handle	eucalipto ahumado smoked eucalyptus	1	212	212
MO_442P21	MOSS frentes . jgo puertas madera bat 1h L80 H32 MOSS accessories . hinged wooden doors set 1h W80 H32	eucalipto ahumado smoked eucalyptus	1	144	144
MO_522E31	MOSS accesorios . estante madera suelto L64 H2 MOSS loose wooden shelf W64 H2	laca mate matt lacquer	1	42	42
MO_471P21	MOSS frentes . BET puerta cristal bat de 1h L48 H32 MOSS accessories . BET right hinged glass door 1h W48 H32	metal negro / dark grey black metal / dark grey	1	262	262
<b>TOTAL</b>					<b>1612</b>
<b>TOTAL</b>					<b>2806</b>

# Q 05

ref	descripción/description	acabado/finish	u	p/u	total
Q3_S5212	Q3 contenedor suspendido . puerta cristal batiente v2 L30 H80 F30 Q3 suspended container . hinged glass door v2 W30 H80 D30	metal negro transparente / roble black metal transparent / oak	1	494	494
OP_1291	OPCIONAL . incremento metal lacado . puerta cristal Q3 OPTIONAL . lacquered metal increment . Q3 glass door	laca mate matt lacquer	1	20	20
Q3_S2111	Q3 contenedor suspendido . puerta madera batiente v1 L30 H40 F30 Q3 suspended container . hinged wooden door v1 W30 H40 D30	roble / laca mate oak / matt lacquer	3	308	924
Q3_S2211	Q3 contenedor suspendido . puerta madera batiente v2 L30 H60 F35 Q3 suspended container . hinged wooden door v2 W30 H60 D35	roble / laca mate oak / matt lacquer	1	322	322
Q3_S5212	Q3 contenedor suspendido . puerta cristal batiente v2 L30 H80 F35 Q3 suspended container . hinged glass door v2 W30 H80 D35	metal negro transparente / roble black metal transparent / oak	1	494	494
OP_1291	OPCIONAL . incremento metal lacado . puerta cristal Q3 OPTIONAL . lacquered metal increment . Q3 glass door	laca mate matt lacquer	1	20	20
Q3_S2111	Q3 contenedor suspendido . puerta madera batiente v1 L30 H40 F35 Q3 suspended container . hinged wooden door v1 W30 H40 D35	roble / laca mate oak / matt lacquer	1	308	308
Q3_S2211	Q3 contenedor suspendido . puerta madera batiente v2 L30 H60 F30 Q3 suspended container . hinged wooden door v2 W30 H60 D30	roble / laca mate oak / matt lacquer	1	322	322
			<b>TOTAL</b>	<b>2904</b>	
BR_13	BRICH bancada tv . 280x45 H35 BRICH tv bench . 280x45 H35	metal negro / roble tapa porcelánico duomo black metal / oak porcelain top duomo	11	980	980
			<b>TOTAL</b>	<b>3884</b>	

# Q 06

ref	descripción/description	acabado/finish	u	p/u	total
Q3_S5311	Q3 contenedor suspendido . puerta cristal batiente v3 L35 H90 F35 Q3 suspended container . hinged glass door v3 W35 H90 D35	laca mate metal negro / transparente matt lacquer black metal / transparent	4	538	2152
<b>ESTRUCTURA/STRUCTURE</b>					
MO_320A41	MOSS v zócalo . aparador asimétrico 1h L231,5 H39 F44 MOSS plate base v . asymmetric sideboard 1h W231.5 H39 D44		1	842	842
	acabado exterior outer finish	roble oak			
	acabado interior inner finish	laca mate matt lacquer			
<b>COMPLEMENTOS/COMPLEMENTS</b>					
MO_442P21	MOSS frentes . jgo puertas madera bat 1h L80 H32 MOSS accessories . hinged wooden doors set 1h W80 H32	roble oak	2	136	272
			<b>TOTAL</b>	<b>1114</b>	
			<b>TOTAL</b>	<b>3266</b>	

# Q 07

ref	descripción/description	acabado/finish	u	p/u	total
Q3_S3221	Q3 contenedor suspendido . puerta madera abatible v2 L110 H30 F30 Q3 suspended container . bottom hung wooden door v2 W110 H30 D30	roble / laca mate oak / matt lacquer	3	568	1704
YO_11M611	<b>ESTRUCTURA/STRUCTURE</b> YOKO estructura . a suelo L178 H40 F32 YOKO structure to floor . W178 H40 D32	laca mate matt lacquer	1	304	304
YO_23S111	YOKO separador . forma doble L1,2 H37 F31 YOKO double form divider . W1,2 H37 D31	laca mate matt lacquer	4	36	144
YO_36C411	<b>COMPLEMENTOS/COMPLEMENTS</b> YOKO contenedor . cristal L57 H35 F35 YOKO glass container . W57 H35 D35	transparente transparent	1	280	280
YO_34C412	YOKO contenedor . cajones L57 H35 F40 YOKO drawers container . W57 H35 D40	roble oak	1	330	330
<b>TOTAL</b>					<b>1058</b>
YO_11M611	<b>ESTRUCTURA/STRUCTURE</b> YOKO estructura . a suelo L178 H40 F32 YOKO structure to floor . W178 H40 D32	laca mate matt lacquer	1	304	304
YO_23S111	YOKO separador . forma doble L1,2 H37 F31 YOKO double form divider . W1,2 H37 D31	laca mate matt lacquer	4	36	144
YO_32C311	<b>COMPLEMENTOS/COMPLEMENTS</b> YOKO contenedor . puerta madera batiente L42 H35 F35 YOKO hinged door container . W42 H35 D35	laca mate matt lacquer	1	184	184
YO_32C411	YOKO contenedor . puerta madera batiente L57 H35 F35 YOKO hinged door container . W57 H35 D35	roble oak	1	268	268
<b>TOTAL</b>					<b>900</b>
<b>TOTAL</b>					<b>3662</b>

# Q 08

ref	descripción/description	acabado/finish	u	p/u	total
Q3_S8221_0	Q3 contenedor suspendido . cajones v2 L110 H35 F40 sin tirador Q3 suspended container . drawers v2 W110 H35 D40 handleless	roble / laca mate oak / matt lacquer	1	694	694
Q2_S3221	Q2 contenedor suspendido . puerta madera abatible v2 L120 H30 F30 Q2 suspended container . bottom hung wooden door v2 W120 H30 D30	laca mate matt lacquer	2	362	724
<b>TOTAL</b>					<b>1418</b>
BR_12	BRICH bancada tv . 230x45 H35	metal negro roble tapa porcelánico paladio	1	880	880
	BRICH tv bench . 230x45 H35	black metal oak porcelain top paladio			
<b>TOTAL</b>					<b>2298</b>

# Q 09

ref	descripción/description	acabado/finish	u	p/u	total
Q1_S1111	Q1 contenedor suspendido . abierto v1 L40 H40 F30 Q1 suspended container . open v1 W40 H40 D30	laca mate matt lacquer	1	170	170
Q1_S1111	Q1 contenedor suspendido . abierto v1 L40 H40 F40 Q1 suspended container . open v1 W40 H40 D40	nogal walnut	1	222	222
Q1_S1111	Q1 contenedor suspendido . abierto v1 L40 H30 F35 Q1 suspended container . open v1 W40 H30 D35	eucalipto ahumado smoked eucalyptus	1	246	246
Q1_S1131	Q1 contenedor suspendido . abierto v1 L70 H30 F30 Q1 suspended container . open v1 W70 H30 D30	laca mate matt lacquer	1	200	200
Q1_S1111	Q1 contenedor suspendido . abierto v1 L40 H40 F30 Q1 suspended container . open v1 W40 H40 D30	laca mate matt lacquer	1	170	170
Q1_S1112	Q1 contenedor suspendido . abierto v1 L30 H50 F35 Q1 suspended container . open v1 W30 H50 D35	laca mate matt lacquer	1	180	180
Q1_S1111	Q1 contenedor suspendido . abierto v1 L40 H40 F40 Q1 suspended container . open v1 W40 H40 D40	nogal walnut	1	222	222
Q1_S1131	Q1 contenedor suspendido . abierto v1 L70 H30 F30 Q1 suspended container . open v1 W70 H30 D30	laca mate matt lacquer	1	200	200
Q1_S1111	Q1 contenedor suspendido . abierto v1 L40 H30 F35 Q1 suspended container . open v1 W40 H30 D35	eucalipto ahumado eucalypto ahumado	1	246	246
Q1_S1131	Q1 contenedor suspendido . abierto v1 L70 H30 F30 Q1 suspended container . open v1 W70 H30 D30	laca mate matt lacquer	1	200	200
Q1_S1111	Q1 contenedor suspendido . abierto v1 L40 H30 F35 Q1 suspended container . open v1 W40 H30 D35	eucalipto ahumado eucalypto ahumado	1	246	246
Q1_S1111	Q1 contenedor suspendido . abierto v1 L40 H40 F40 Q1 suspended container . open v1 W40 H40 D40	nogal walnut	1	222	222
Q1_S1112	Q1 contenedor suspendido . abierto v1 L30 H50 F35 Q1 suspended container . open v1 W30 H50 D35	laca mate matt lacquer	1	180	180
<b>TOTAL</b>					<b>2704</b>

# Q 10

ref	descripción/description	acabado/finish	u	p/u	total
Q1_S1131	Q1 contenedor suspendido . abierto v1 L80 H30 F30 Q1 suspended container . open v1 W80 H30 D30	laca mate matt lacquer	1	200	200
Q1_S1121	Q1 contenedor suspendido . abierto v1 L60 H30 F35 Q1 suspended container . open v1 W60 H30 D35	laca mate matt lacquer	1	184	184
Q1_S1211	Q1 contenedor suspendido . abierto v2 L30 H60 F35 Q1 suspended container . open v2 W30 H60 D35	laca mate matt lacquer	1	216	216
Q2_S2122	Q2 contenedor suspendido . puerta madera batiente v1 L45 H45 F30 Q2 suspended container . hinged wooden door v1 W45 H45 D30	roble oak	2	292	584
Q2_S8131_2	Q2 contenedor suspendido . cajones v1 L80 H35 F40 tirador pomo negro Q2 suspended container . drawers v1 W80 H35 D40 knob black handle	laca mate matt lacquer	1	358	358
Q2_S2121	Q2 contenedor suspendido . puerta madera batiente v1 L45 H35 F30 Q2 suspended container . hinged wooden door v1 W45 H35 D30	roble oak	1	282	282
<b>TOTAL</b>					<b>1824</b>

# Q 11

ref	descripción/description	acabado/finish	u	p/u	total
Q1_S1111	Q1 contenedor suspendido . abierto v1 L30 H30 F30 . laca mate Q1 suspended container . open v1 W30 H30 D30 . matt lacquer	laca mate matt lacquer	3	170	510
Q2_S5111	Q2 contenedor suspendido . puerta cristal batiente v1 L40 H40 F35  Q2 suspended container . hinged glass door v1 W40 H40 D35	metal negro dark grey / laca mate  black metal dark grey / matt lacquer	2	340	680
Q2_S3131	Q2 contenedor suspendido . puerta madera abatible v1 L80 H30 F35 Q2 suspended container . bottom hung wooden door v1 W80 H30 D35	roble oak	1	348	348
Q2_S3121	Q2 contenedor suspendido . puerta madera abatible v1 L50 H35 F40 Q2 suspended container . bottom hung wooden door v1 W50 H35 D40	roble oak	2	326	652
<b>TOTAL</b>				<b>2190</b>	

# Q 12

ref	descripción/description	acabado/finish	u	p/u	total
Q1_S1111	Q1 contenedor suspendido . abierto v1 L40 H30 F30 Q1 suspended container . open v1 W40 H30 D30	roble oak	1	222	222
Q1_S1111	Q1 contenedor suspendido . abierto v1 L40 H30 F35 Q1 suspended container . open v1 W40 H30 D35	roble oak	1	222	222
Q1_S1121	Q1 contenedor suspendido . abierto v1 L60 H30 F30 Q1 suspended container . open v1 W60 H30 D30	roble oak	1	244	244
Q2_S8131_1	Q2 contenedor suspendido . cajones v1 L80 H30 F40 tirador embutido negro Q2 suspended container . drawers v1 W80 H30 D40 inlay black handle	laca mate matt lacquer	1	362	362
Q1_S1131	Q1 contenedor suspendido . abierto v1 L80 H30 F35 Q1 suspended container . open v1 W80 H30 D35	roble oak	1	276	276
<b>TOTAL</b>				<b>1326</b>	



# Q 13

ref	descripción/description	acabado/finish	u	p/u	total
Q3_S3131	Q3 contenedor suspendido . puerta madera abatible v1 L70 H40 F30 Q3 suspended container . bottom hung wooden door v1 W70 H40 D30	eucalipto ahumado / laca mate eucalipto ahumado / laca mate	1	460	460
Q3_S5211	Q3 contenedor suspendido . puerta cristal batiente v2 L40 H65 F35 Q3 suspended container . hinged glass door v2 W40 H65 D35	metal negro dark grey / eucalipto a  black metal dark grey / smoked eucalyptus	1	588	588
Q1_S1122	Q1 contenedor suspendido . abierto v1 L50 H45 F40 Q1 suspended container . open v1 W50 H45 D40	laca mate matt lacquer	1	192	192
Q3_S3121	Q3 contenedor suspendido . puerta madera abatible v1 L60 H35 F35 Q3 suspended container . bottom hung wooden door v1 W60 H35 D35	eucalipto ahumado / laca mate smoked eucalyptus / matt lacquer	1	418	418
<b>TOTAL</b>				<b>1658</b>	

# Q 14

ref	descripción/description	acabado/finish	u	p/u	total
Q3_S2311	Q3 contenedor suspendido . puerta madera batiente v3 L40 H85 F35 Q3 suspended container . hinged wooden door v3 W40 H85 D35	roble / laca mate oak / matt lacquer	1	512	512
Q3_S2122	Q3 contenedor suspendido . puerta madera batiente v1 L55 H50 F35 Q3 suspended container . hinged wooden door v1 W55 H50 D35	roble / laca mate oak / matt lacquer	1	354	354
Q3_S2121	Q3 contenedor suspendido . puerta madera batiente v1 L55 H35 F35 Q3 suspended container . hinged wooden door v1 W55 H35 D35	roble / laca mate oak / matt lacquer	1	336	336
<b>TOTAL</b>				<b>1202</b>	

ref	descripción/description	acabado/finish	u	p/u	total
Q3_S2122	Q3 contenedor suspendido . puerta madera batiente v1 L55 H50 F35 Q3 suspended container . hinged wooden door v1 W55 H50 D35	roble / laca mate oak / matt lacquer	1	354	354
Q3_S2111	Q3 contenedor suspendido . puerta madera batiente v1 L40 H35 F35 Q3 suspended container . hinged wooden door v1 W40 H35 D35	roble / laca mate oak / matt lacquer	1	308	308
Q3_S2121	Q3 contenedor suspendido . puerta madera batiente v1 L55 H35 F35 Q3 suspended container . hinged wooden door v1 W55 H35 D35	roble / laca mate oak / matt lacquer	1	336	336
Q3_S2112	Q3 contenedor suspendido . puerta madera batiente v1 L40 H50 F35 Q3 suspended container . hinged wooden door v1 W40 H50 D35	roble / laca mate oak / matt lacquer	1	326	326
<b>TOTAL</b>				<b>1324</b>	
<b>TOTAL</b>				<b>2526</b>	

Diseño Gráfico\_Graphic Design  
*Ximo Roca Diseño*

Imágenes\_Images  
*Vertice Fotógrafos*

Impresión\_Printed by  
*Rafa Sanz*

Creaciones Loyra S.L.

Argenters, 21 - Pol. Ind. L'Alter  
Apdo. de Correos, 111  
46290 Alcàsser, Valencia - Spain

[www.loyratime.com](http://www.loyratime.com)

CREACIONES LOYRA © 2021

Reservados todos los derechos. Esta publicación no puede ser copiada total o parcialmente por cualquier medio sin previa autorización del editor. Todos los modelos están protegidos mediante patente internacional.

*All rights reserved. This publication may not be reproduced in whole or in part in any manner whatsoever without the permission of the publisher. All models are protected by international patent.*

