

The Collection 2020

ACACIA

Inspired by the ancient baobab, the table collection is made of rattan poles fastened together to create sculptural and fluid contours. The natural and raw assemblage of rattan is a striking contrast to the more streamlined and minimalist table top.

Acacia rectangular dining table in natural.



ACACIA



DINING TABLE, rectangular

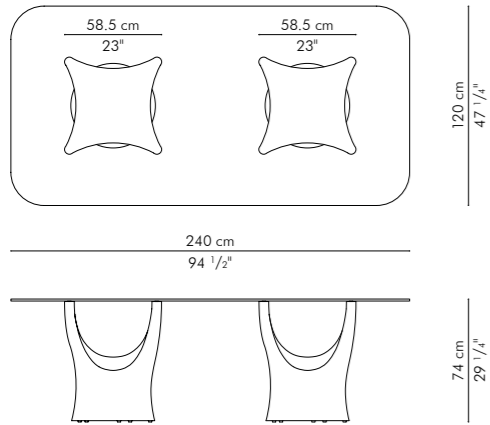

Standard glass size:
240 cm W x 120 cm D x 12 mm thickness
(94 1/2" W x 47 1/4" D x 1/2"), pencil edge



DINING TABLE ROUND, large

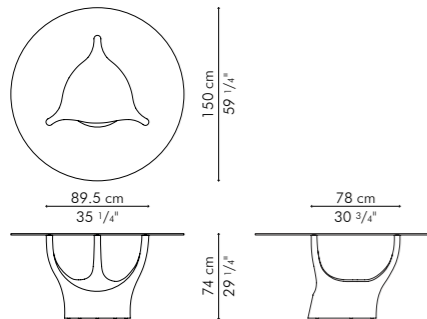

Standard glass size:
150 cm Ø x 12 mm thickness
(59" Ø x 1/2"), pencil edge

INDOOR rattan, steel



DINING TABLE ROUND, regular

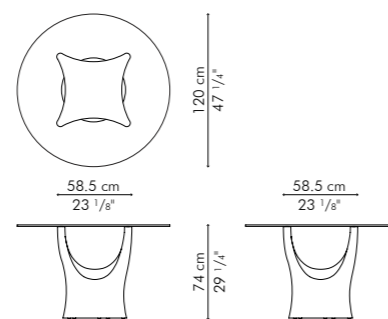

Standard glass size:
120 cm Ø x 12 mm thickness
(47 1/4" Ø x 1/2"), pencil edge



COFFEE TABLE

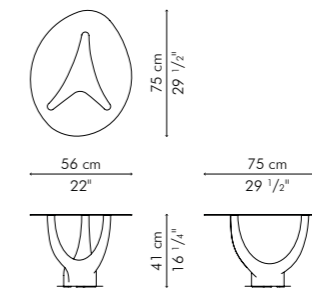

END TABLE

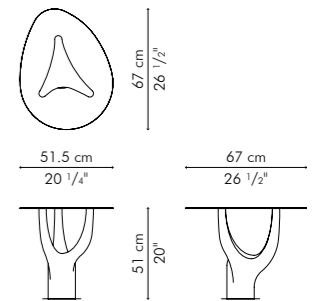

INDOOR rattan, steel

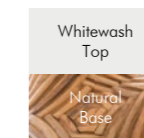

ADESSO

The boldly colored frame and geometric weave pattern of Adesso brings to mind a summer field of flowers. Coupled with a dining table that showcases clean, solid lines, the exuberant interplay of patterns, colors, and lines results in a carefree collection that will complement any decor.

Adesso armchairs in brown and dining tables in pale gray.

Designed by Federica Capitani



ARMCHAIR

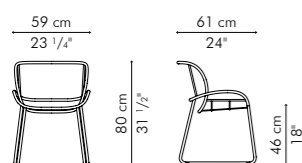

OUTDOOR polyethylene, aluminum

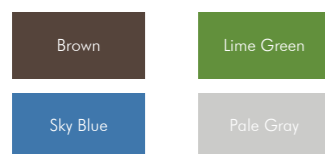

DINING TABLE

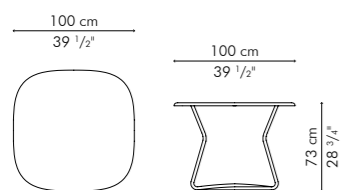

OUTDOOR fiberglass, aluminum

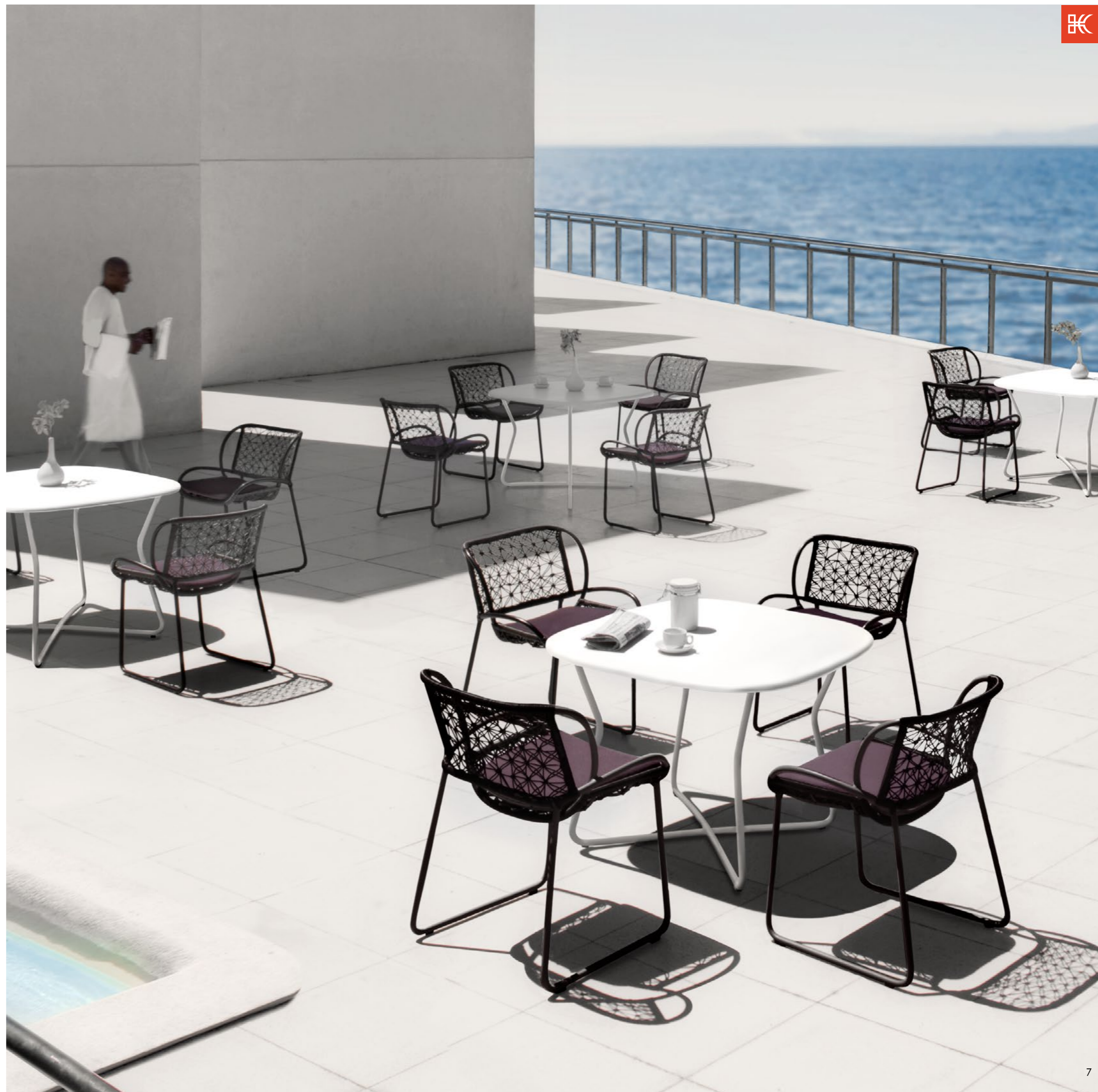

AMAYA & DIMPLE

Its design inspired by fish traps, the Amaya dining table projects an aura of a vortex trapped within a cylinder.

Amaya dining tables in brown and Dimple stacking armchairs in bronze.



Amaya end and coffee tables in brown.



Dimple stacking armchairs in bronze.



AMAYA

DINING TABLE, large

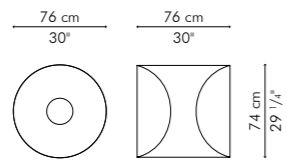

Standard glass size:
137 cm Ø x 12 mm thickness
(54" Ø x 1/2"), pencil edge

DINING TABLE, regular

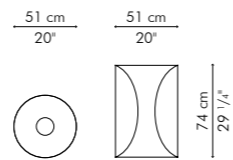

Standard glass size:
122 cm Ø x 12 mm thickness
(48" Ø x 1/2"), pencil edge

COFFEE TABLE

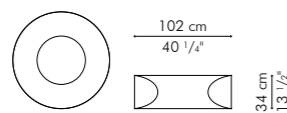

Standard glass size:
102 cm Ø x 12 mm thickness
(40 1/4" Ø x 1/2"), pencil edge

END TABLE

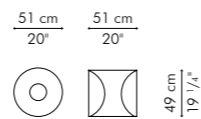

Standard glass size:
51 cm Ø x 10 mm thickness
(20" Ø x 3/8"), pencil edge

INDOOR abaca, steel

OUTDOOR polyethylene, steel

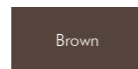
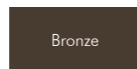
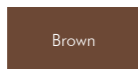

DIMPLE

STACKING ARMCHAIR

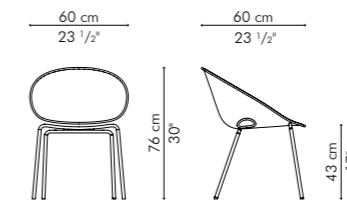

OUTDOOR polyethylene, steel, stainless steel

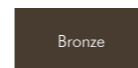

ANNIKA

With the soft curves of the seat complemented by the straight and rigid lines of the frame, Annika is a contemporary play on contrasts.



ARMCHAIR

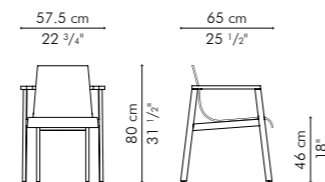

SIDE CHAIR

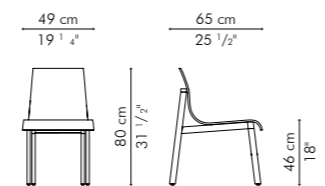

INDOOR maple and polyester fabric

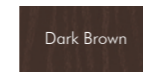
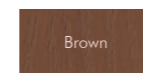

Annika armchairs in brown with the Suzy Wong buffet cabinet.



APOLLO

Apollo is for those whose imagination and childlike wonder never left them. A blast from the past of building makeshift forts as a kid, this spaceship for the young at heart has an open weave that allows air to flow through for a comfortable and leisurely rest.

The Apollo daybed accompanied by Lulu club chairs and a Croissant coffee table – all in brown.



DAYBED

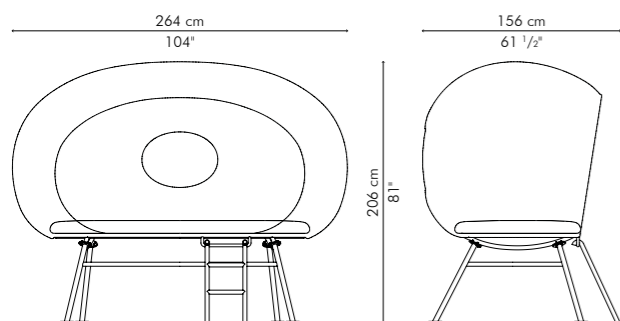

OUTDOOR polyethylene, aluminum

Brown



ARIA

Aria combines a lightweight powder-coated aluminum frame with a unique handcrafted weaving pattern that's rich in texture. This collection epitomizes the value of simply enjoying time to relax both indoors and outdoors.

Aria chaise lounges in hershey.

Designed by Federica Capitani



ARIA

CHAISE LOUNGE

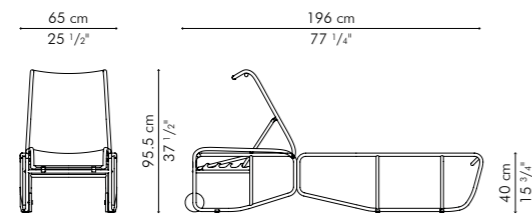

EASY ARMCHAIR

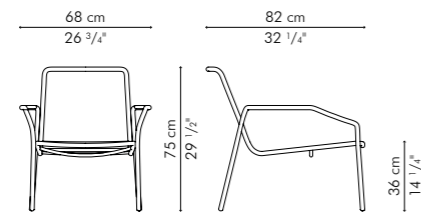

C-TABLE

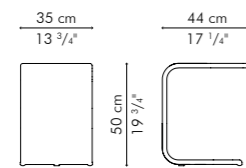

OUTDOOR polyethylene, aluminum



Snowflake



Matcha

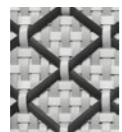

Macchiato

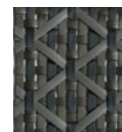

Hershey

END TABLE

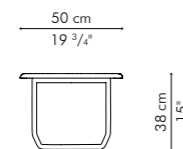

OUTDOOR glass fiber reinforced concrete (GFRC), aluminum

Pale Gray

Aria easy armchairs in snowflake and the end table in pale gray.



BABAR

Part cabinet, part study, the majestic frame of the Babar is wrapped with a unique weaving pattern inspired by the rough texture of elephant skin. This piece evolves into a working desk with a drawer and several compartments for tomes and artifacts.

Babar cabinet in natural with the Harry rocking stool.

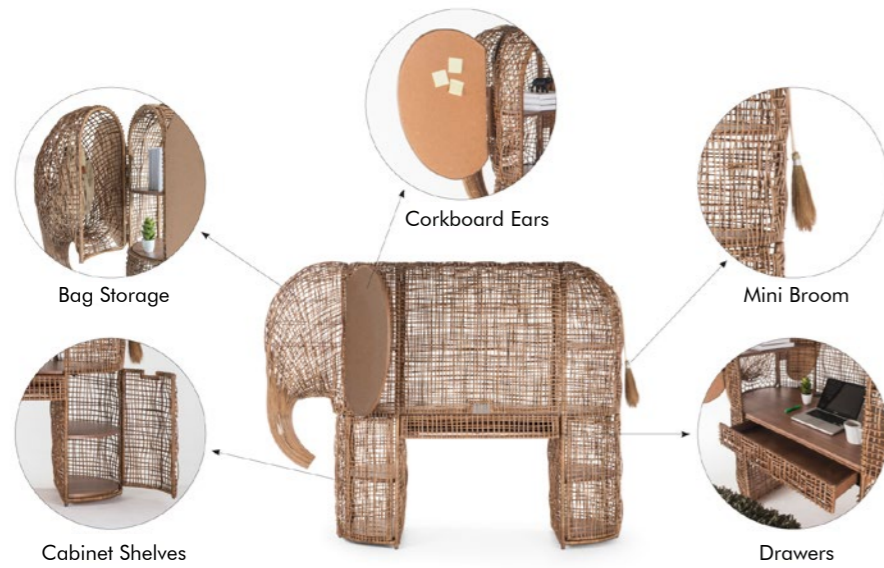

CABINET

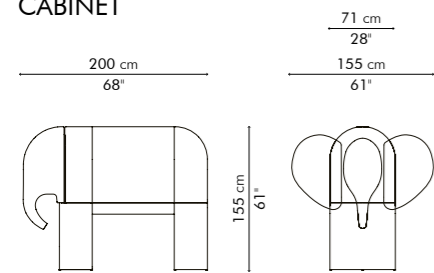

INDOOR rattan, wood, cork, steel

Natural



BALOU

The Balou easy armchair exudes comfort through its round plump form. Its transparent design gives the impression of sitting on air.

Set 1: Balou outdoor easy armchair, small coffee table, and ottoman in brown;

Set 2: Balou outdoor easy armchair and small coffee table in natural.



EASY ARMCHAIR

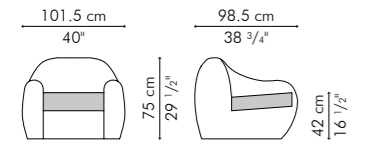

OTTOMAN

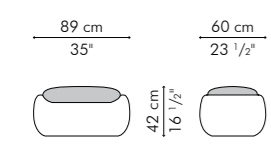

INDOOR abaca, rattan, nylon, steel

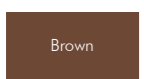

OUTDOOR polyethylene, steel

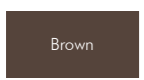



Balou outdoor easy armchairs, sofa, small and medium coffee tables in brown.

BALOU

SOFA

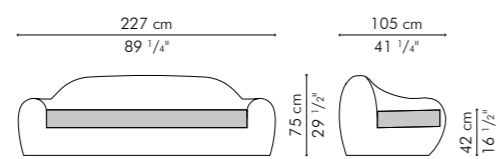

INDOOR abaca, rattan, nylon, steel

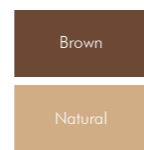

LOVESEAT

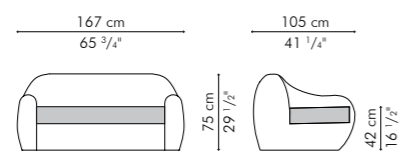

OUTDOOR polyethylene, steel

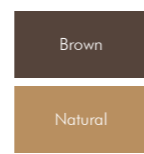

COFFEE TABLE, medium

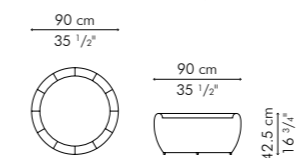

Standard glass size:
69.5 cm Ø x 10 mm thickness
(27 1/4" Ø x 3/8"), frosted, swiped edge

INDOOR abaca, rattan, nylon, steel

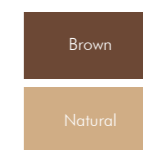

COFFEE TABLE, small

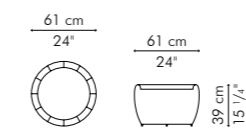

Standard glass size:
44.5 cm Ø x 6 mm thickness
(17 1/2" Ø x 1/4"), frosted, swiped edge

OUTDOOR polyethylene, steel

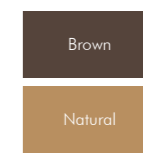

BLOOM

Welcome the organic beauty of the garden indoors. Inspired by a delicate blossom, the Bloom is composed of hundreds of fine running stitches that radiate from the center of the seat.

Bloom swivel easy armchairs in moss green and yellow.



BLOOM



black with copper base

EASY ARMCHAIR, swivel

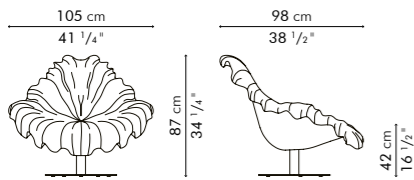

INDOOR microfiber, fiberglass reinforced polymer and steel



muted red



tangerine



yellow



lime green



moss green



black

Bloom swivel easy armchair in cobalt blue.



cobalt blue

BOUQUET

The Bouquet catches the spectator's eye as it stands prominent across an organic landscape. The delicate lines of the signature floral relief pattern decorates a fiberglass reinforced polymer top with a contrasting stainless steel base.

(Right Page) Detail of the Bouquet coffee and end tables in white.



COFFEE TABLE

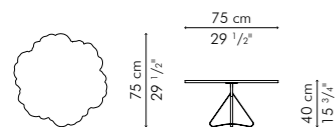

END TABLE

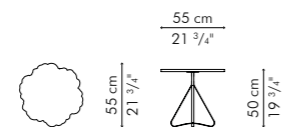

INDOOR fiberglass reinforced polymer and stainless steel



OUTDOOR fiberglass reinforced polymer and stainless steel



CABARET

Cabaret provides a modern take on the brand's sought-after craftsmanship techniques. The innovative technique of weaving fabric-wrapped foam on a steel frame lends sophistication to any space.

Cabaret outdoor lounge chairs, easy armchairs, highback sofa, coffee table, and end table in pale gray.





Cabaret indoor easy armchair, lounge chair, and highback sofa, regular coffee table, and end table in charcoal.



SOFA, highback

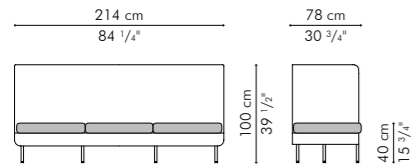

SOFA, lowback

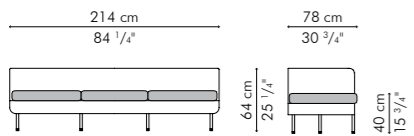

LOVESEAT, highback

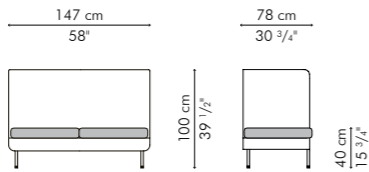

LOVESEAT, lowback

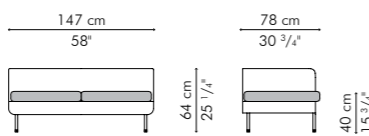

LOUNGE CHAIR

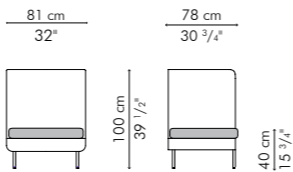

EASY ARMCHAIR

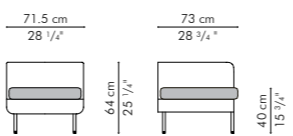

COFFEE TABLE

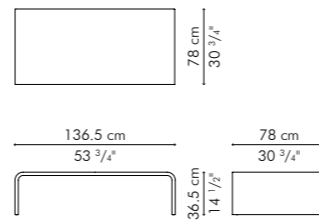

END TABLE

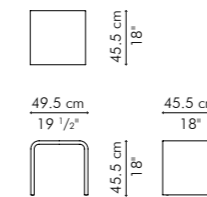

INDOOR fiberglass reinforced polymer, polyester fabric, urethane foam



OUTDOOR fiberglass reinforced polymer, acrylic fabric, reticulated foam

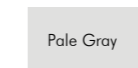

INDOOR polyester fabric, urethane foam, steel, stainless steel

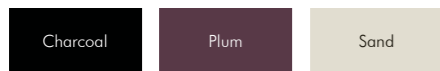

OUTDOOR acrylic fabric, reticulated foam, steel, stainless steel

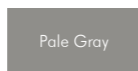



Cabaret European King bed in plum.



Cabaret indoor highback sofa and easy armchair, lounge chair, regular coffee table, and end table in charcoal.

CABARET



BED, American king

239 cm	208 cm
94"	82"
INSIDE FRAME	INSIDE FRAME
204 cm	194 cm
80 1/4"	76 1/4"



BED, American queen

239 cm	167 cm
94"	66"
INSIDE FRAME	INSIDE FRAME
204 cm	153.5 cm
80 1/4"	60 1/2"



BED, European Extra king

234 cm	214 cm
92"	84 1/4"
INSIDE FRAME	INSIDE FRAME
200 cm	200 cm
78 3/4"	78 3/4"

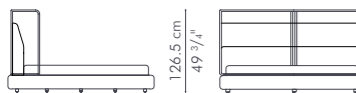

BED, European king

234 cm	194 cm
92"	76 1/4"
INSIDE FRAME	INSIDE FRAME
200 cm	180 cm
78 3/4"	70 3/4"



BED, European queen

234 cm	174 cm
92"	68 1/2"
INSIDE FRAME	INSIDE FRAME
200 cm	160 cm
78 3/4"	63"



INDOOR polyester fabric, urethane foam, wood, steel



Cabaret outdoor lounge chair, easy armchairs, highback sofa, regular coffee table, and end table in pale gray.



CALYX

Like the lustrous diamond, Calyx features a matrix of interwoven polyethylene strands and a wide crown, making any space stylish with its elegant silhouette.

Calyx lowback easy armchairs, loveseat, coffee table, and end table in whitewash.

CALYX

EASY ARMCHAIR, highback

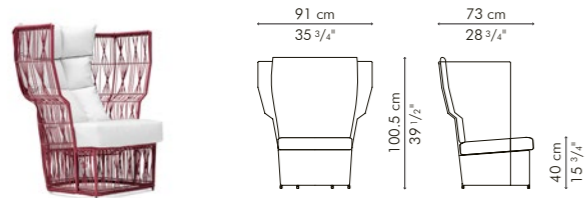

LOVESEAT

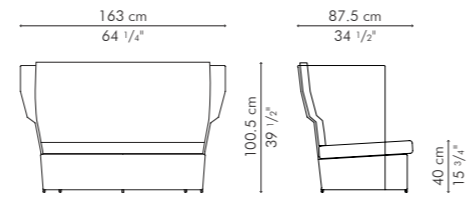

EASY ARMCHAIR, lowback

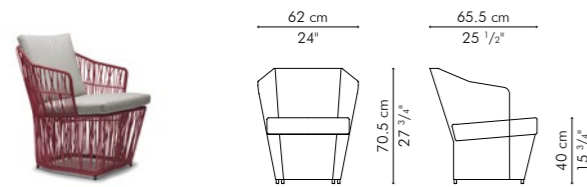

ARMCHAIR

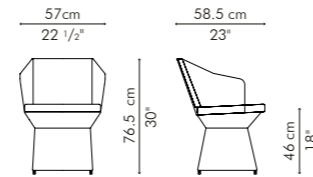

COFFEE TABLE

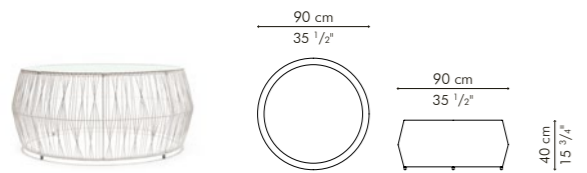

END TABLE

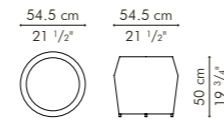

Standard glass size:
76.5 cm Ø x 10 mm thickness
(30" Ø x 3/8"), pencil edge

Standard glass size:
41.5 cm Ø x 10 mm thickness
(16 1/4" Ø x 3/8"), pencil edge

OUTDOOR polyethylene, steel



BISTRO TABLE

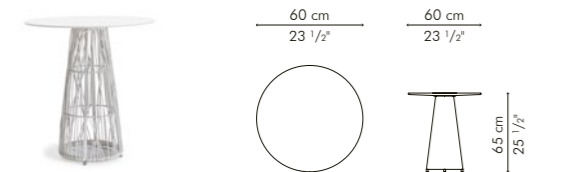

DINING TABLE

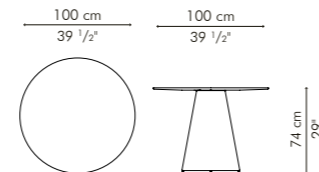

OUTDOOR polyethylene, steel, stonecast



Calyx armchairs and dining table in whitewash.



Calyx highback easy armchairs in burgundy and the end table in whitewash.





Chiquita stools in black, denim blue, and orchid pink.



orchid pink



denim blue



tangerine



sky blue



pearl white



black



silver



chocolate brown

CHIQUITA

The Chiquita stool has a secret to tell but only for those fortunate enough to enjoy its charms. Rigid-looking vertical sections of rattan poles unexpectedly recede into the seat for a pleasant surprise and sitting experience like no other.



muted red

STOOL

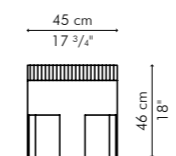

INDOOR rattan, polyurethane foam, steel

Silver	Chocolate Brown	Sky Blue
Muted Red	Denim Blue	Tangerine
Black	Orchid Pink	Pearl White



CROISSANT

The distinctive shape of the Croissant collection promotes a posture of leisure, its low arms beckoning to be reclined upon.

Croissant outdoor easy armchairs, sofa, and end table in brown.





Croissant indoor easy armchairs and end table in brown.

CROISSANT



SOFA

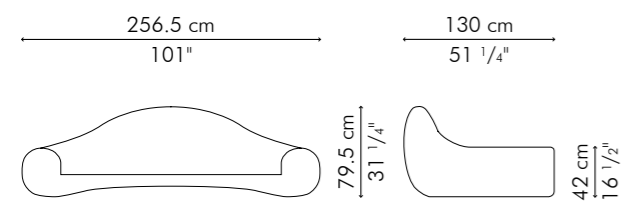

EASY ARMCHAIR

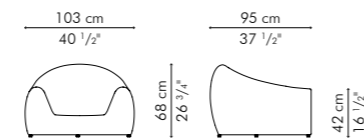

COFFEE TABLE, large

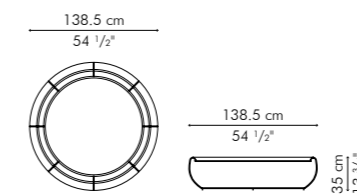

Standard glass size:
119.5 cm Ø x 10 mm thickness
(47" Ø x 3/8"), frosted, swiped edge



COFFEE TABLE, medium

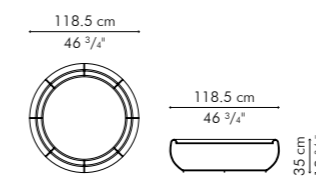

Standard glass size:
100 cm Ø x 10 mm thickness
(39 1/2" Ø x 3/8"), frosted, swiped edge



END TABLE

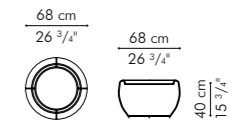

Standard glass size:
50 cm Ø x 6 mm thickness
(19 3/4" Ø x 1/4"), frosted, swiped edge



INDOOR abaca, nylon, steel

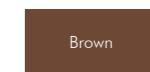

OUTDOOR polyethylene, steel

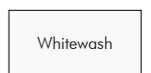
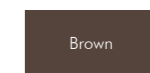



Dolly easy armchairs in pale gray and bistro table.



DOLLY

Dolly is a dainty easy armchair that's made for comfort. Inspired by the traditional beach chair, Dolly has a special vintage charm that's all its own.

EASY ARMCHAIR

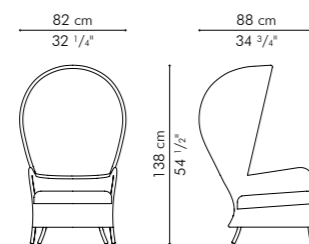

OUTDOOR polyethylene, acrylic fabric, aluminum

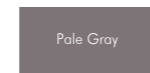

BISTRO TABLE

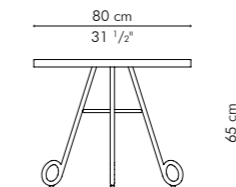

OUTDOOR fiberglass, aluminum

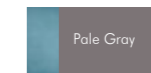

DRAGNET

Inspired by fishermen's nets and created from fabric twisted and wrapped around a steel frame, the Dragnet lounge chair surrounds you like a cocoon.



LOUNGE CHAIR

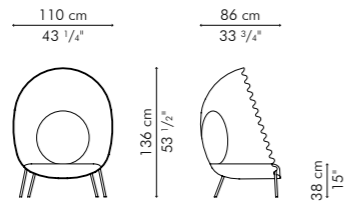

HANGING LOUNGE CHAIR

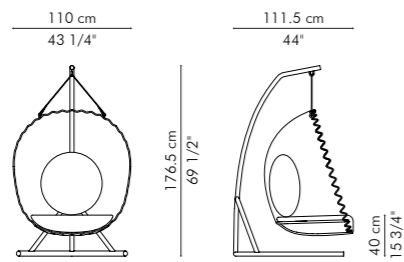

SWING

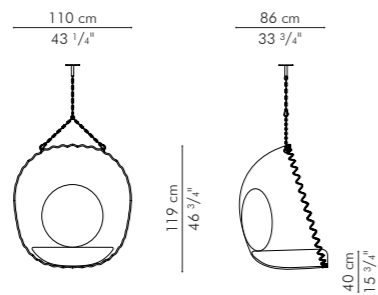

INDOOR polycotton, steel, stainless steel



OUTDOOR acrylic fabric, steel, stainless steel



DREAMCATCHER

Dreamcatcher is our seating adaptation of a traditional Native American charm.

STOOL, 120

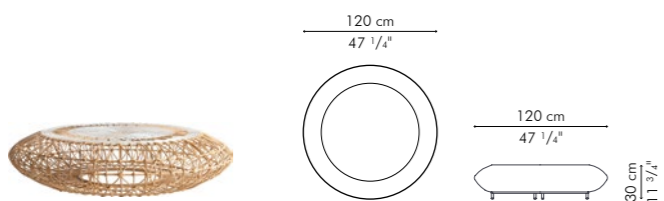

STOOL, 100

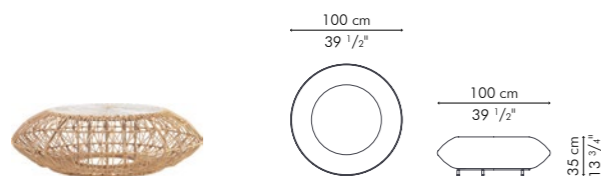

STOOL, 80

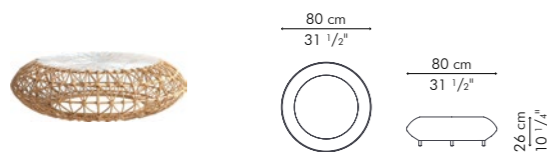

STOOL, 50

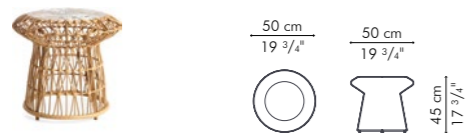

OUTDOOR polyethylene, nylon, steel

Natural

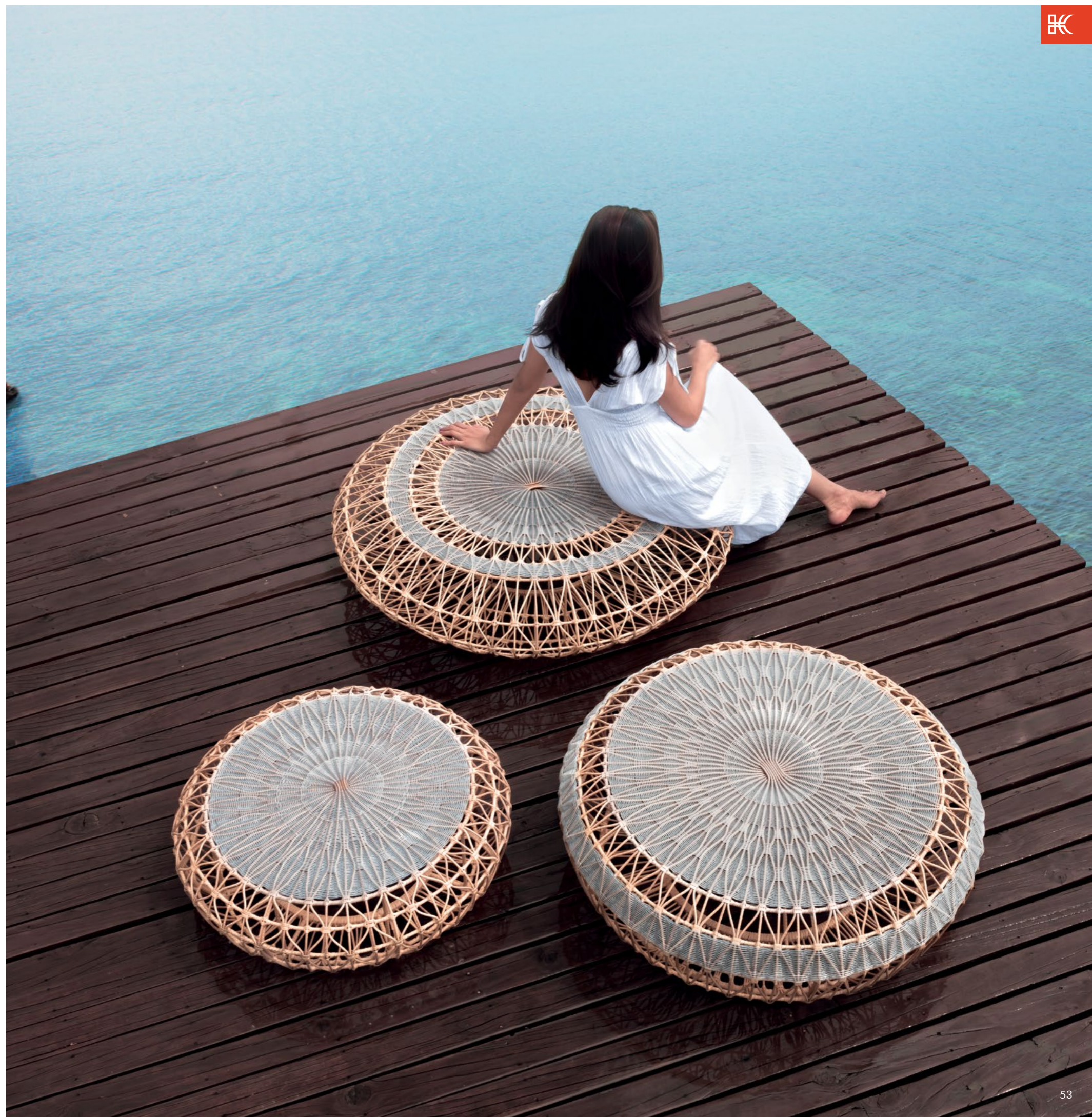

FORMA

A contemporary collection perfect for both indoor and outdoor spaces, the balanced shape of the armchair and the daybed makes them ideal to recline in.

Designed by Federica Capitani, the thin steel frame is dressed with threads of three different diameters emphasizing Forma's modern feel.





FORMA OUTDOOR



DAYBED

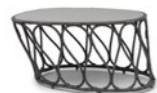
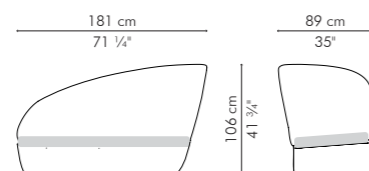

COFFEE TABLE

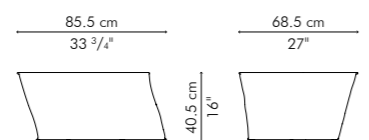

END TABLE

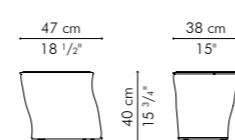

EASY ARMCHAIR, left

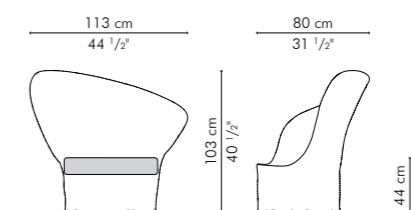

EASY ARMCHAIR, petite right

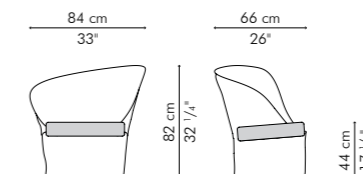

EASY ARMCHAIR, right

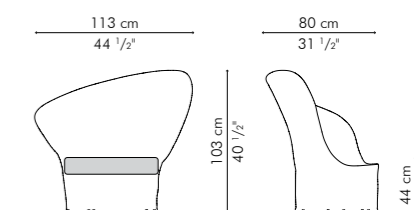

EASY ARMCHAIR, petite left

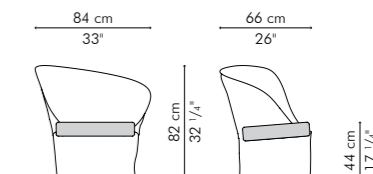

BISTRO TABLE

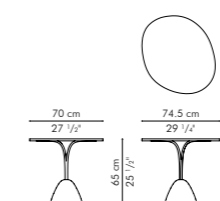

OUTDOOR polyethylene, steel



FORMA INDOOR



LOVESEAT

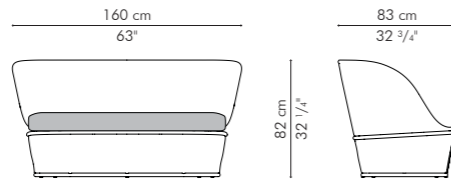

EASY ARMCHAIR, petite right

EASY ARMCHAIR, petite left

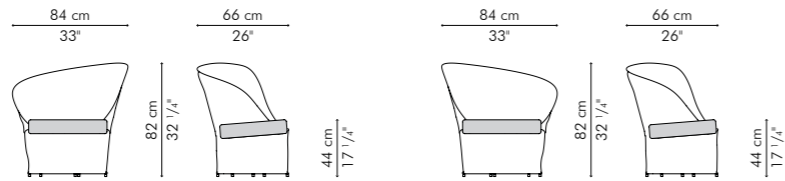

COFFEE TABLE

END TABLE

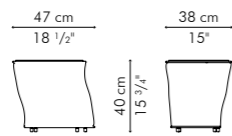
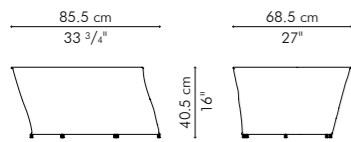

SIDE CHAIR

DINING TABLE

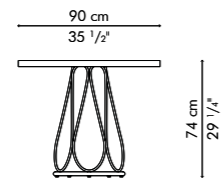
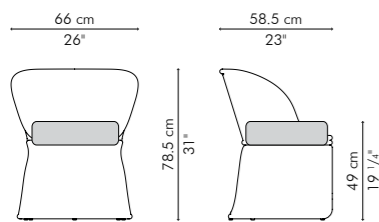

INDOOR rattan

INDOOR fiberglass, steel

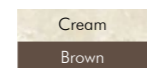

GOBI

Inspired by the characteristic form of the cactus, Gobi is a striking set of tables with its copper tones and a hammered finish. Each piece is handmade and unique creating rich visual textures, made not only to be decorative, but also functional.

DINING TABLE

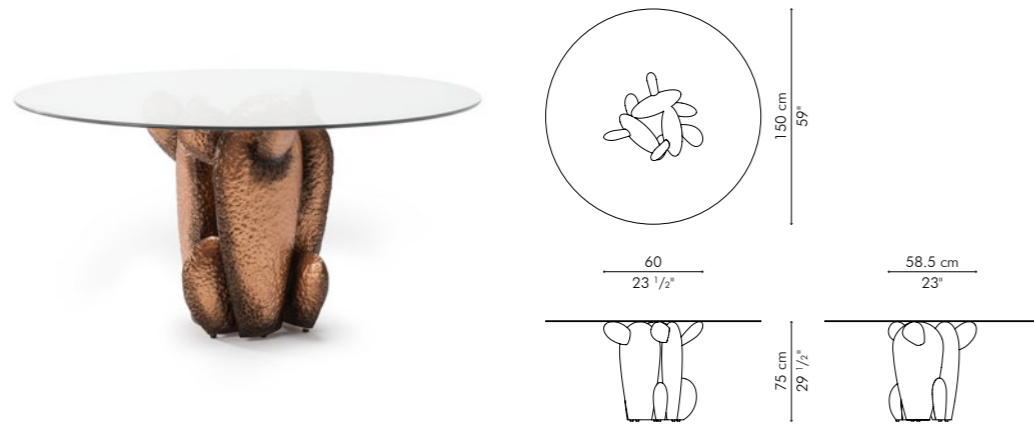

Standard glass size:
150 cm Ø x 12 mm thickness
(59" Ø x 1/2"), pencil edge

COFFEE TABLE, low

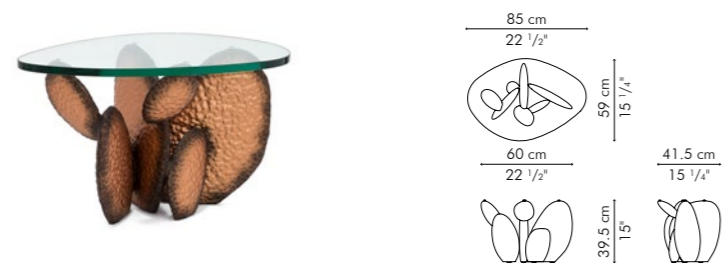

Standard glass size:
59 cm D x 85 cm W x 19 mm thickness
(23 1/4" D x 33 1/2" W x 3/4"), hubble edge

COFFEE TABLE, high



Standard glass size:
45 cm D x 66 cm W x 19 mm thickness
(17 3/4" D x 26" W x 3/4"), hubble edge

INDOOR steel





HAGIA

Your search for shade ends with the Hagia collection. Bask in regal luxury as its gothic temperament gratifies you with a lofty haven.

Hagia daybed, easy armchair, coffee table, and end table in black.

HAGIA



DAYBED

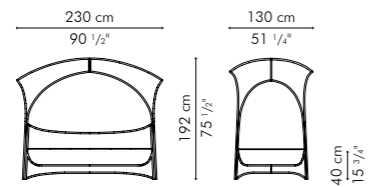

EASY ARMCHAIR

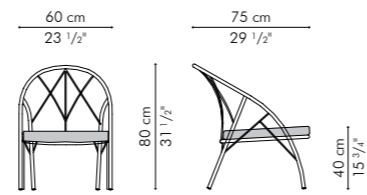

COFFEE TABLE

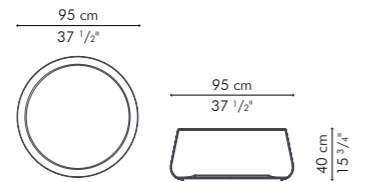

END TABLE

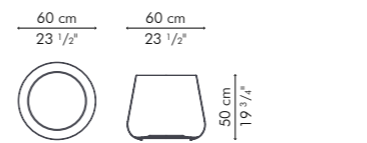

Standard glass size:
79 cm Ø x 10 mm thickness
(31" Ø x 3/8"), swiped edge, frosted

Standard glass size:
42.5 cm Ø x 6 mm thickness
(16 3/4" Ø x 1/4"), swiped edge, frosted

SIDE CHAIR

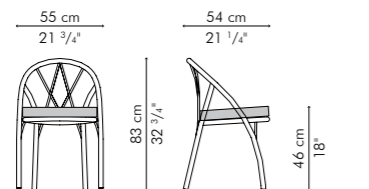

DINING TABLE

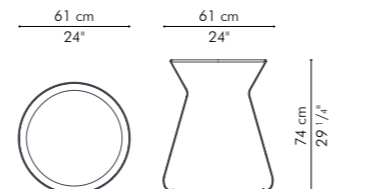

Standard glass size:
100 cm Ø x 12 mm thickness
(39 1/2" Ø x 1/2"), pencil edge, frosted

OUTDOOR polyethylene, nylon, steel



HARRY

A rocking stool topped in microfiber strips stiched to interchangeable covers, Harry will bring out the child in everyone.



yellow



lime green



moss green



muted red



brown



black

ROCKING STOOL

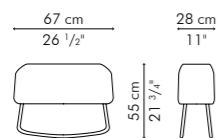

INDOOR microfiber, urethane foam, stainless steel, plywood

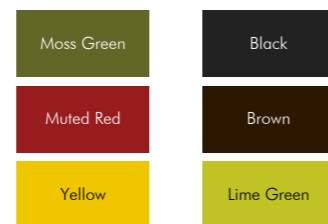

KAJA

Transform your living room into an indoor garden with Kaja. Made of naturally crushed stones and a welded powder-coated metal base, this collection seamlessly marries clean, simple lines with the organic beauty of nature.



COFFEE TABLE

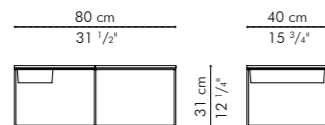

END TABLE, high

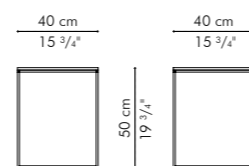

END TABLE, low

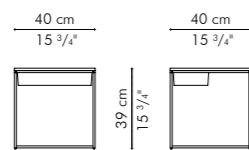

C-TABLE

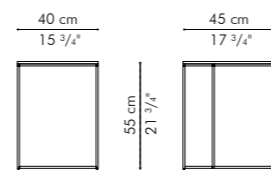

INDOOR steel, stonecast



LA LUNA

La Luna's quiet sophistication is defined by a soft, round shape that feels like a snug embrace. This collection is made of rattan and maple, and features two different weaves that seamlessly merge, making it a classic masterpiece in the art of weaving.

EASY ARMCHAIR

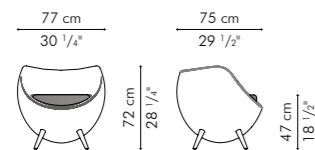

OTTOMAN

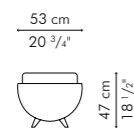

INDOOR rattan, rattan peel, polyurethane foam, maple

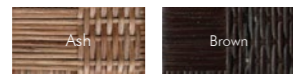

LUNA

OCCASIONAL TABLE, 80

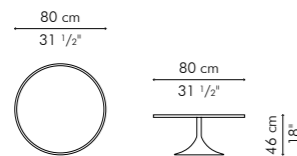

OCCASIONAL TABLE, 60

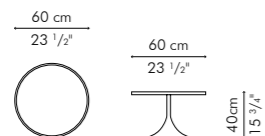

OCCASIONAL TABLE, 50

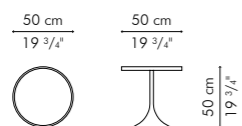

INDOOR rattan, high-pressure laminate, maple

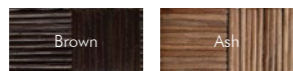

The highlight of the piece can be found along the ridge of the arms and backrest, where two different weaves, inside and out, seamlessly merge.



LASSO

Drift away on a flight of dreams in Lasso, a visual expression of the story of storks carrying babies to their homes. Made of rattan and steel covered in warm and cool hues, Lasso is a cradle of solitude and comfort.

*Bird sculpture is sold separately.



LOUNGE CHAIR

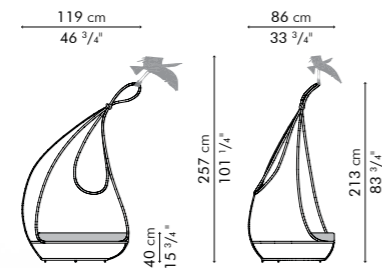

OTTOMAN

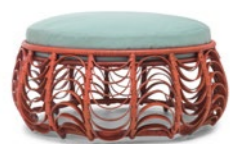
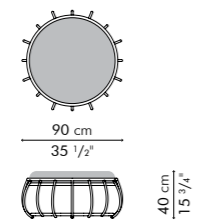

INDOOR rattan, steel

Terracotta

OUTDOOR polyethylene, aluminum

Terracotta

Pale Gray



Lasso lounge chair and ottoman in terracotta with the Acacia coffee table in whitewash natural and the Cloud hanging lamp.





LOLAH

Created using traditional boat-building techniques, the Lolah is constructed of thin rattan strips cut with planer knives and fastened over a light rattan frame. Presented with the Design for Asia Award - Asia's highest award for design - Lolah entices the sitter with its sensuous form, economy of the material and structural beauty.

Lolah indoor set consisting of the capsule in whitewash, the sofa in dark brown, easy armchair in whitewash, and the large oval coffee table and end table in dark brown and whitewash respectively.

LOLAH



BAR CABINET (INDOOR USE ONLY)

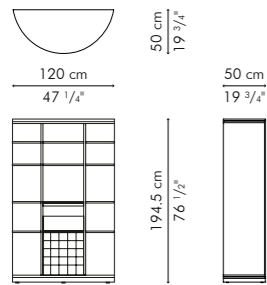

SOFA

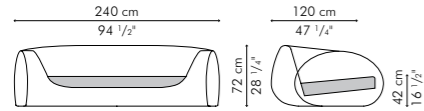

COFFEE TABLE, oval large

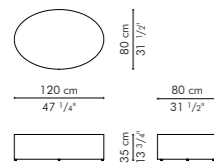

Standard glass size:
78 cm D x 118 cm W x 10 mm thickness
(30 3/4" D x 46 1/2" W x 3/8"), frosted, swiped edge

INDOOR rattan, nylon

Dark Brown

Whitewash



CAPSULE, 2 seater (OUTDOOR VERSION ONLY)

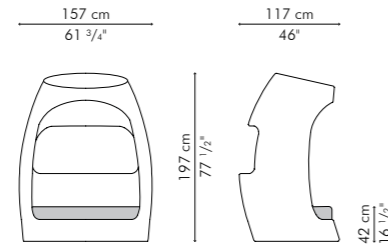

EASY ARMCHAIR

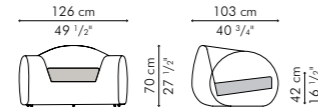

COFFEE TABLE, oval medium

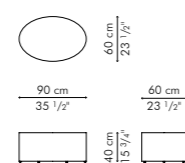

Standard glass size:
58 cm D x 88 cm W x 6 mm thickness
(22 3/4" D x 34 3/4" W x 1/4"), frosted, swiped edge

OUTDOOR polyethylene, aluminum

Brown

Whitewash



CAPSULE, 1 seater

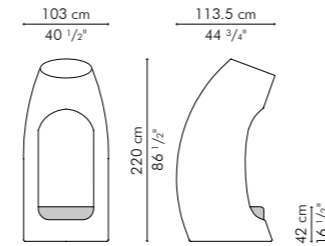

END TABLE

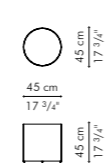

Standard glass size:
44 cm Ø x 6 mm thickness
(17 1/4" Ø x 1/4"), frosted, swiped edge





LOLITA

We developed a unique weave for the Lolita stacking side chair and shaped the contours of its back to hug yours.



STACKING SIDE CHAIR

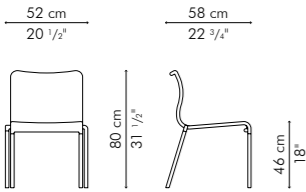

OUTDOOR polyethylene, stainless steel, aluminum

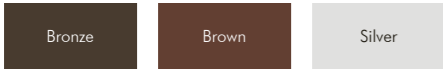

MARCEL

The Marcel collection complements any outdoor space with pieces that are made for comfort.



STACKING ARMCHAIR

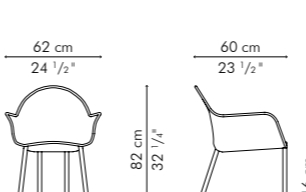

EASY ARMCHAIR

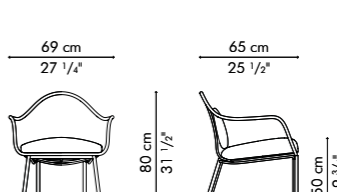

OUTDOOR polyethylene, stainless steel, aluminum

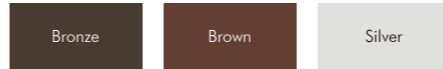



LULU

Lulu adds grace to any space with its clean, nest-like silhouette. Its open weave allows air to pass through, resulting in a cool lounging experience.



LULU



EASY ARMCHAIR

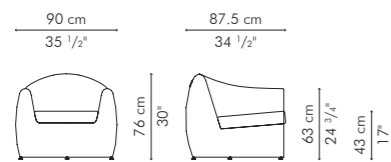

CLUB CHAIR

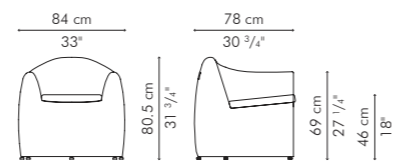

INDOOR abaca, nylon, steel

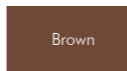

OUTDOOR polyethylene, steel

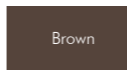



MANOLO

Inspired by the seductive curves of a woman's sandal, Manolo's sinuous lines channel sensuality not unlike that of a come-hither prance. Manolo is made of polyethylene strands hand-tied over a steel frame and bound with nylon.



EASY ARMCHAIR

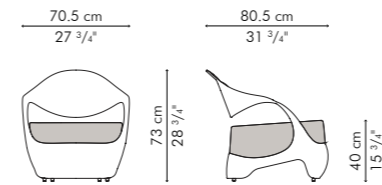

END TABLE

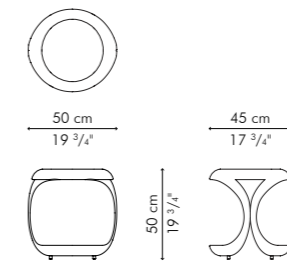

INDOOR rattan, nylon, steel

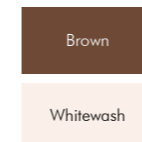

OUTDOOR polyethylene, nylon, steel

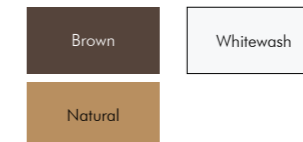

MASON

Jars are typically placed on shelves and cupboards. Mason is a reimagining of that, transforming these storage tools into life-sized tables you can fill with conversations over coffee.



COFFEE TABLE, high

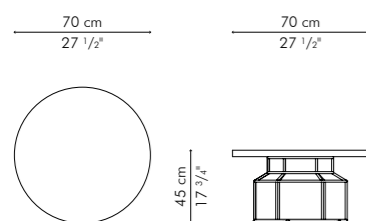

COFFEE TABLE, low

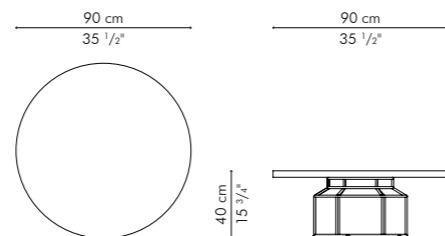

END TABLE

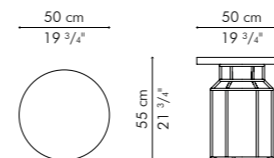

INDOOR walnut, steel

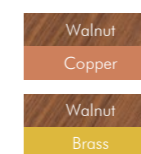

OUTDOOR fiberglass, aluminum

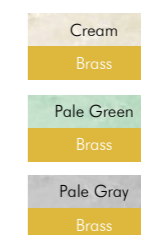

MATILDA

The Matilda relies on a minimal skeletal rattan frame and thick rattan strips to create a strong, tight structure that applies the same principle as a woven basket.

Its robust contours constitute a handsome counterpoint in an outdoor setting.

Outdoor version in polyethylene and aluminum.



MATILDA



SOFA

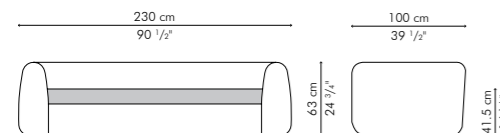

EASY ARMCHAIR

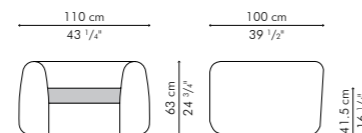

EASY CHAIR

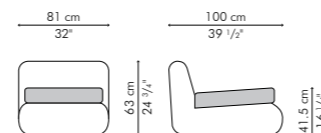

COFFEE TABLE



Standard glass size:
121 cm W x 71 cm D x 10 mm thickness
(47 3/4" W x 28" D x 3/8"), frosted, swiped edge



END TABLE, round

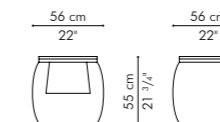

Standard glass size: (outdoor)
TOP 45 cm Ø x 6 mm thickness
(17 3/4" Ø x 1/4"), frosted, swiped edge
SHELF 50.5 cm Ø x 6 mm thickness
(20" Ø x 1/4"), frosted, swiped edge

INDOOR rattan, steel

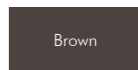

OUTDOOR polyethylene, aluminum

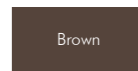

MERMAID

From the imagination of alluring mythology emerges the voluptuous and runway-ready Mermaid.

Designed by Peter Hertel & Sebastian Klarhoefer



CHAISE LOUNGE

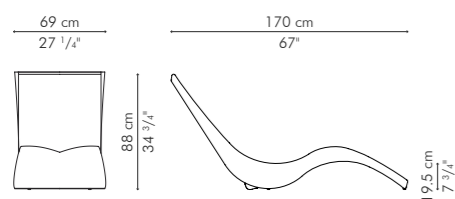

END TABLE

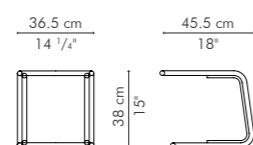

OUTDOOR polyethylene, aluminum

- Bronze
- Silver
- White



NOODLE

A creation of rattan vines bent in fluid lines that derive from random doodling, Noodle evokes the excitement inherent in the accidents that drive the imagination.

NOODLE



LOVESEAT

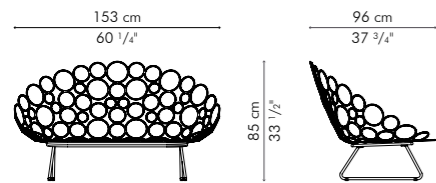

INDOOR rattan, nylon, steel, stainless steel

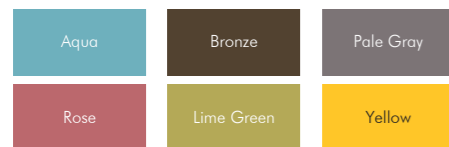

EASY ARMCHAIR

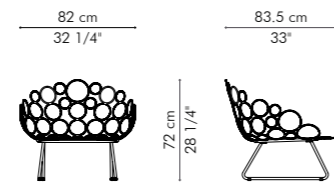

OUTDOOR polyethylene, nylon, steel, stainless steel



ARMCHAIR

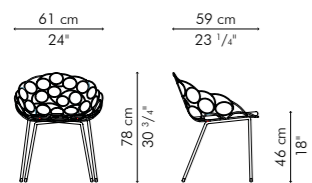

INDOOR rattan, nylon, steel, stainless steel

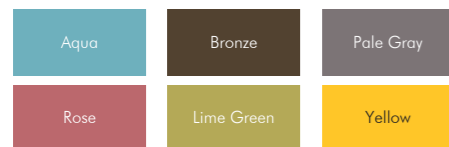

OUTDOOR polyethylene, nylon, steel, stainless steel





OASIS

Inspired by the delicate shape of the tulip,
Oasis provides soothing comfort.



OASIS



LOVESEAT

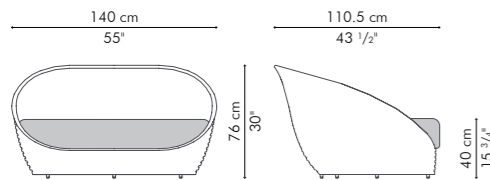

COFFEE TABLE

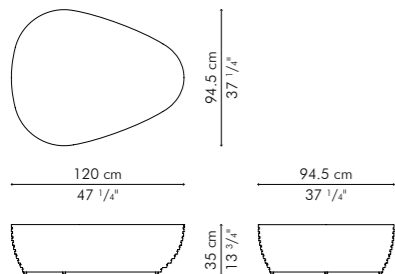

Standard glass size:
118 cm D x 92.5 cm W x 10 mm thickness
(46 1/2" D x 36 1/2" W x 3/8"), frosted, swiped edge

OUTDOOR polyethylene, aluminum



LOUNGE CHAIR

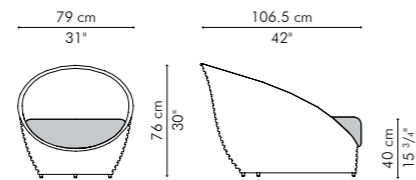

END TABLE

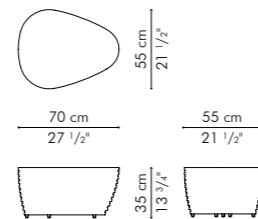

Standard glass size:
68 cm D x 53 cm W x 6 mm thickness
(26 3/4" D x 20 3/4" W x 1/4"), frosted, swiped edge



PAPILLON

The Papillon easy armchair features handwoven polyethylene on a frame that's shaped to resemble a butterfly's fluttering wings.



EASY ARMCHAIR

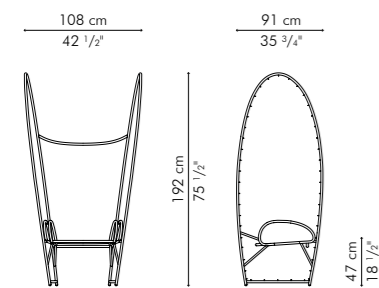

OTTOMAN

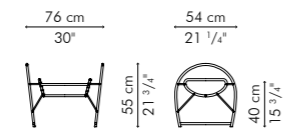

OUTDOOR polyethylene, steel

Whitewash





PARCHMENT

Inspired by bound manuscripts, the edges and surfaces of the Parchment collection respects the natural effect of time on paper



PARCHMENT



LOVESEAT

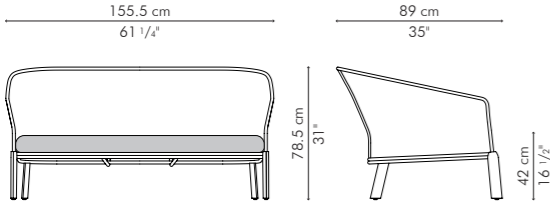

EASY ARMCHAIR

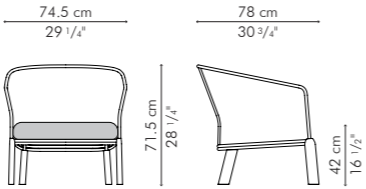

ARMCHAIR

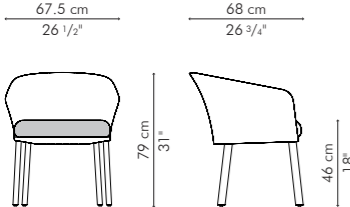

INDOOR maple, steel

Canvas	Heather Beige	Spa
Dove	Graphite	Taupe
Bay Brown	Navy	



PEACOCK

Peacock is a modern take on the traditional wicker chair of the same name. Like the majestic bird, this lounge chair truly stands out among the flock.



EASY CHAIR

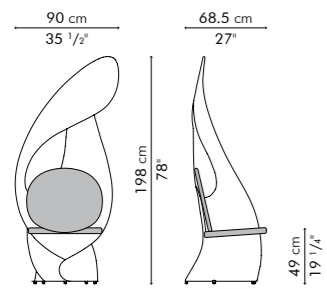

INDOOR rattan, steel

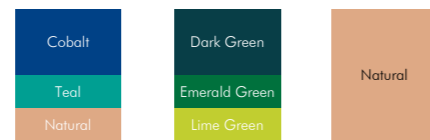

END TABLE

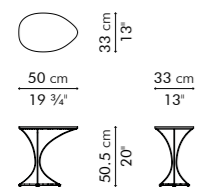

INDOOR beech wood, steel

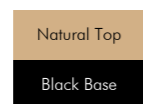

PEBBLE

Tabletops echo shapes found in nature. Arrange the Pebble tables to mimic stepping stones in a riverbed, a forest canopy or simply situate these slender masterpieces throughout the living room.



COFFEE TABLE, medium

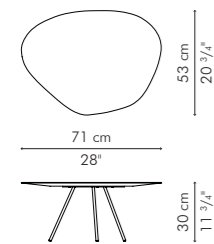

COFFEE TABLE, small

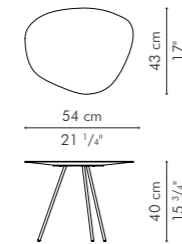

END TABLE, high

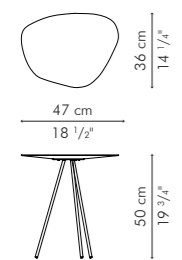

END TABLE, low

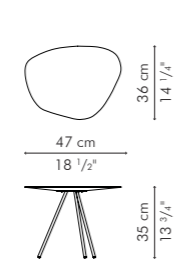

INDOOR sapele, macassar or walnut, steel

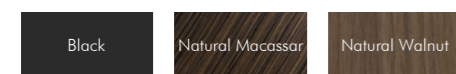

OUTDOOR steel

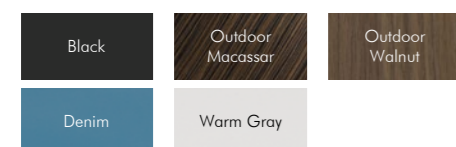

PIGALLE

The inspiration behind Pigalle stems from a classic source:
the very contours of a woman's body.

Strands of abaca rope are individually hand-tied with more
than 3000 knots over a hand-sculptured steel frame.





PIGALLE



LOVESEAT

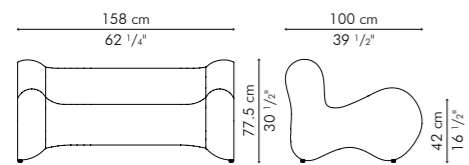

EASY ARMCHAIR

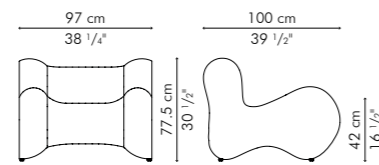

BARSTOOL

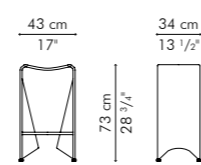

INDOOR abaca, nylon, steel



OUTDOOR polyethylene, steel





RAPUNZEL

Settle into Rapunzel and let a story emerge from beneath the fine wool braids. Thick hand-coiled upholstered foam curves over a steel frame.

INDOOR polypile, urethane foam, stainless steel, steel

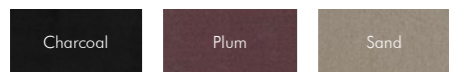

EASY ARMCHAIR

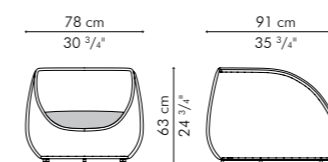

OTTOMAN

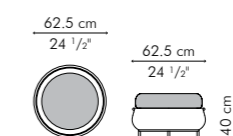

RINGO

March to the beat of your own drum with Ringo. The lightness of the intricately strung open weave adds a subtle groove to any space.



COFFEE TABLE

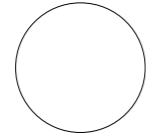

90 cm
35 1/2"

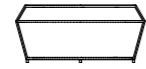

40 cm
15 3/4"

Standard glass size:
73 cm Ø x 10 mm thickness
(28 3/4" Ø x 3/8"), frosted, swiped edge

END TABLE, short



57 cm
22 1/2"



44 cm
17 1/2"

Standard glass size:
38 cm Ø x 6 mm thickness
(15" Ø x 1/4"), frosted, swiped edge

END TABLE, tall



43 cm
17"



53 cm
20 3/4"

Standard glass size:
33 cm Ø x 6 mm thickness
(13" Ø x 1/4"), frosted, swiped edge

OUTDOOR polyethylene, aluminum



RUSSELL

Russell brings the allure of escape to your space. Rest in its airy woven frame as stories of adventure across the land, seas, and sky are being told.



LOVESEAT

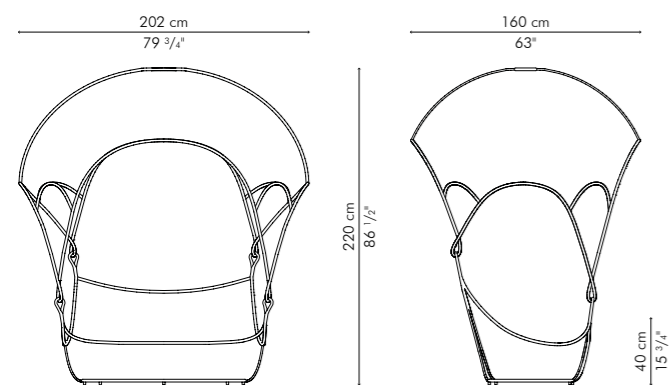

EASY ARMCHAIR

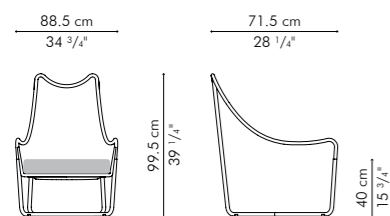

OUTDOOR polyethylene, aluminum

Pale Gray



SUZY WONG

Woven panels create a feeling of intimacy while defining space within a room.



SUZY WONG



SOFA, highback

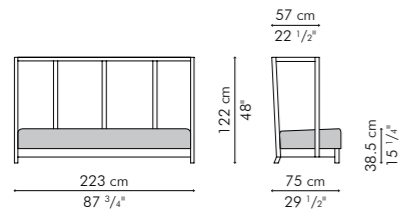

LOVESEAT, highback

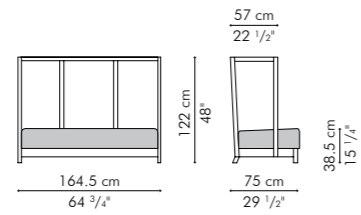

EASY ARMCHAIR, highback

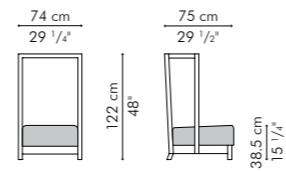

SOFA, lowback

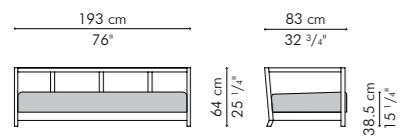

LOVESEAT, lowback

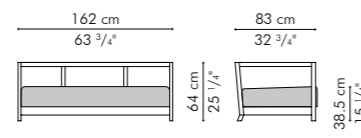

EASY ARMCHAIR, lowback

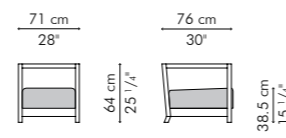

CABINET

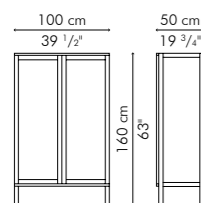

BUFFET CABINET

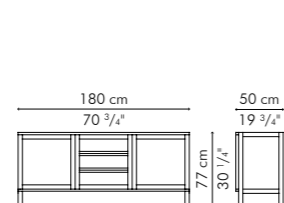

ENTERTAINMENT CONSOLE

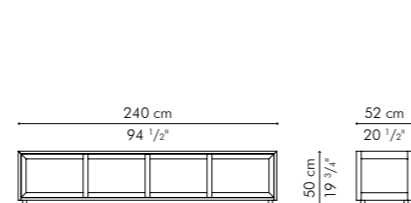

INDOOR abaca, rattan, maple or lampakanai, rattan, walnut



TILT

The Tilt chair is handmade in our workshops to very precise standards by our best wood craftsmen. The pieces are individually cut, sanded, and joined at different angles to create a work of art that celebrates masterful joinery. Tilt pays homage to the centuries-old tradition of woodworking.



EASY ARMCHAIR

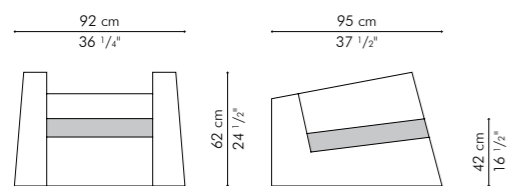

INDOOR maple or walnut



TRAME

This vibrantly-hued collection features an innovative design by Federica Capitani. Pushing the boundaries of traditional weaving, Trame has five interlocking asymmetrical loops that create interesting shapes.



TRAME



ARMCHAIR

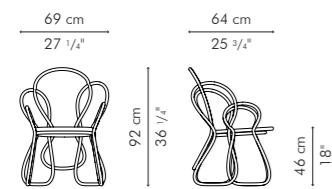

EASY ARMCHAIR

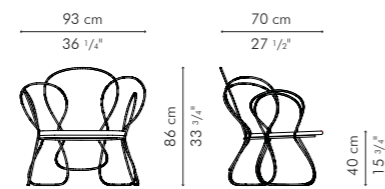

OUTDOOR polyethylene, nylon, steel



DINING TABLE

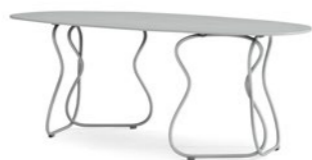
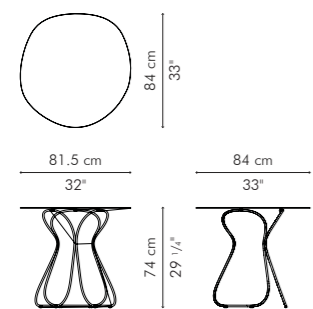

COFFEE TABLE

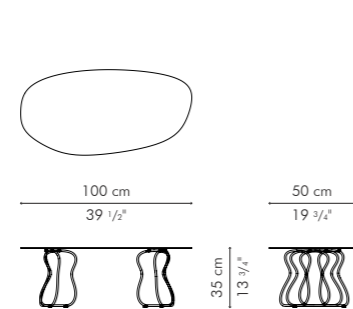

END TABLE

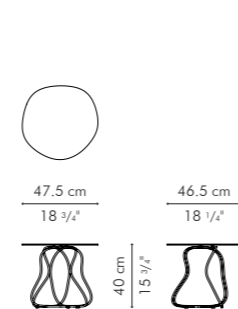

OUTDOOR fiberglass, steel

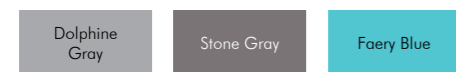



TROPEZ

Oversized armrests made of thick woven rattan strips punctuate the minimalist silhouette of Tropez. Understated details and clean lines result in a comfortable collection that is architectural in proportion and timeless in design.



SOFA

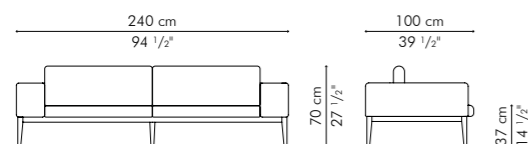

EASY ARMCHAIR

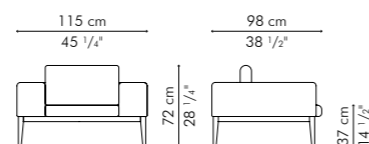

INDOOR rattan, ash, steel



OUTDOOR polyethylene, aluminum





VIVO

Vivo features lithe forms made of hand-bent metal sheets, inspired by the age-old tradition of fine jewelry making. Its antique copper finish adds to the striking filigree, and to the harmonious balance between pure design and artisanal craft.



VIVO

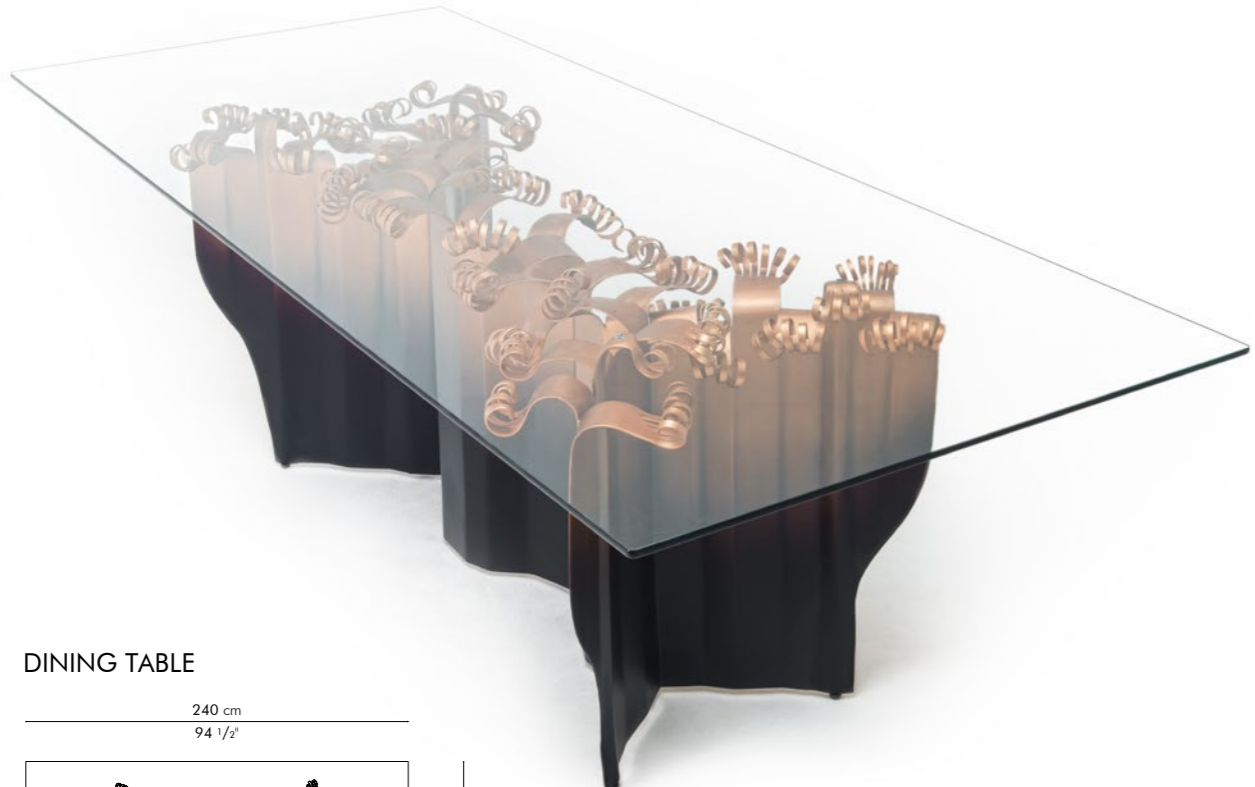

DINING TABLE

240 cm
94 1/2"

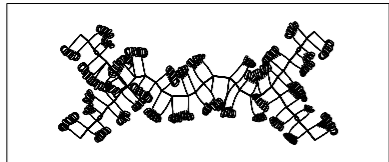

110 cm
43 1/2"

Standard glass size:
110 cm D x 240 cm W x 12 mm thickness
(43 1/2" D x 94 1/2" W x 1/2"), bevel edge

174 cm
68 1/2"

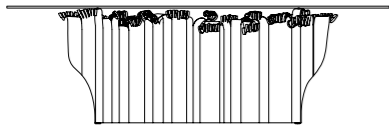

74 cm
29 1/4"

77.5 cm
30 1/2"

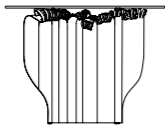

INDOOR steel

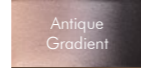

ARMCHAIR

61.5 cm
24 1/4"



80 cm
31 1/2"

55.5 cm
21 3/4"



50 cm
19 3/4"

INDOOR wood, fabric

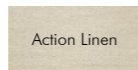
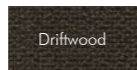



VOYAGE

We believe that whenever we fall asleep at night, we journey to a world of dreams. What better way to travel than in a bed reminiscent of papyrus and reed boats.



VOYAGE



BED, American king

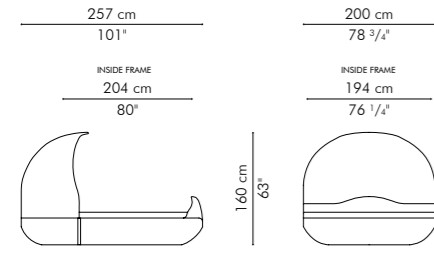

BED, American queen

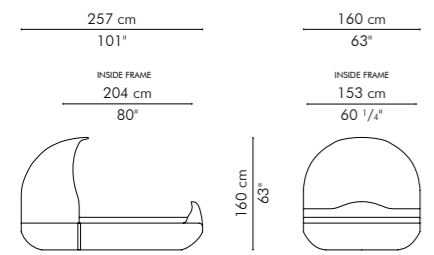

BED, European extra king

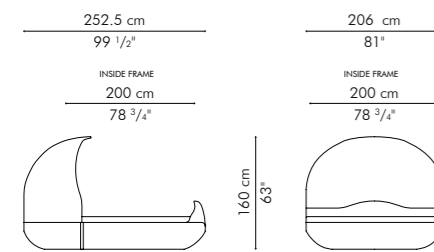

BED, European king

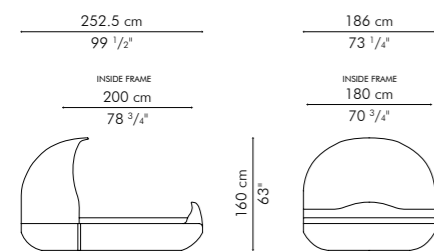

BED, European queen

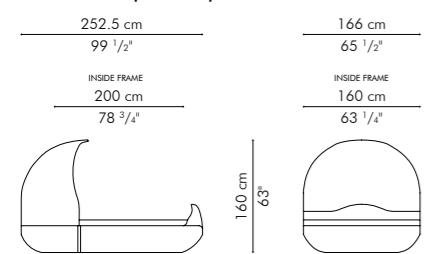

NITE TABLE

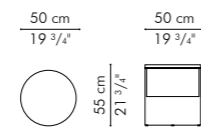

INDOOR abaca, nylon, steel

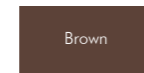

LE PETIT

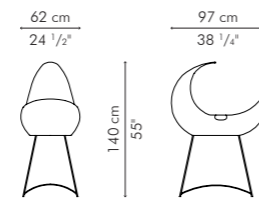

INDOOR rattan, nylon, steel

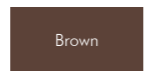



WAVE

With wooden elements arranged in the likeness of an ocean current, Wave is as much a sculpture as it is a table. Fashioned from solid walnut or maple, it captures and solidifies the undulation of the salty sea in a rhythmic, sculptural form that's graceful and profound.

WAVE



DINING TABLE, large

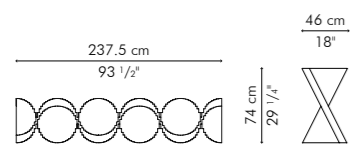

Standard glass size:
110 cm D x 300 cm W x 12 mm thickness
(43 1/2" x 118" x 1/2"), pencil edge

DINING TABLE, medium

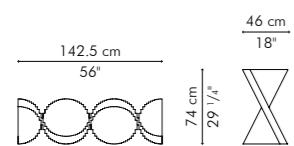

Standard glass size:
100 cm D x 200 cm W x 12 mm thickness
(39 1/2" x 78 3/4" x 1/2"), pencil edge

DINING TABLE, small

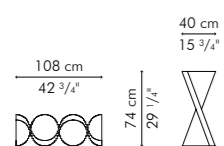

Standard glass size:
80 cm D x 160 cm W x 12 mm thickness
(31 1/2" x 63" x 1/2"), pencil edge

INDOOR maple or walnut



YIN & YANG

The Yin & Yang incarnates a fusion of opposing elements: geometric with organic, pliable rattan with rigid steel and solid form with transparent volume.

This first design in the KC collection was destined to be a classic.



YIN & YANG



EASY ARMCHAIR

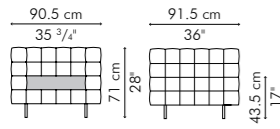

SOFA

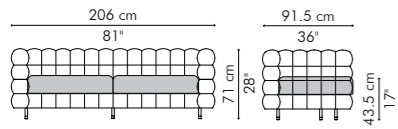

L-SOFA

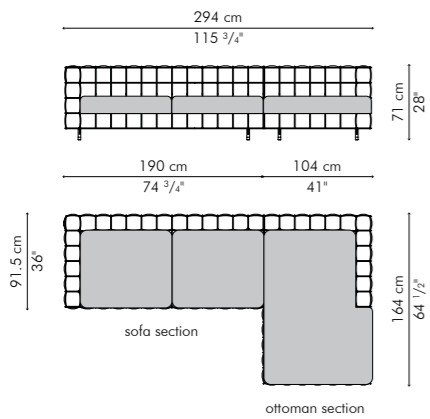

INDOOR rattan, rattan peel, stainless steel, steel



LOVESEAT

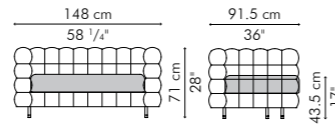

SOFA, extra large

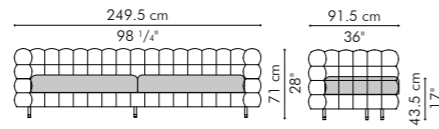

OTTOMAN, large

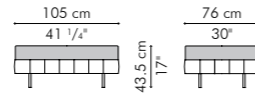

OTTOMAN, regular

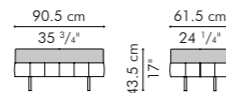

OUTDOOR polyethylene, stainless steel, steel



YIN & YANG



DINING TABLE, rectangular

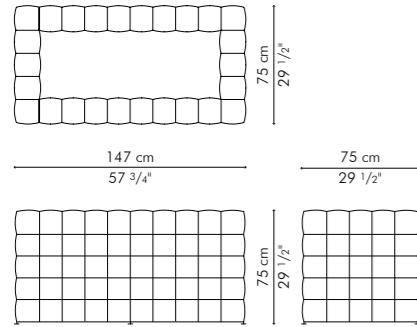

Standard glass size:
137 cm D x 223.5 cm W x 12 mm thickness
(54" D x 88" W x 1/2"), pencil edge



DINING TABLE, round

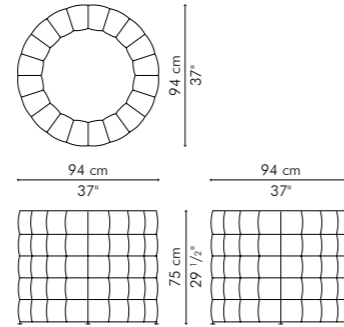

Standard glass size:
152 cm Ø x 12 mm thickness
(60" Ø x 1/2"), pencil edge



DINING TABLE, square regular

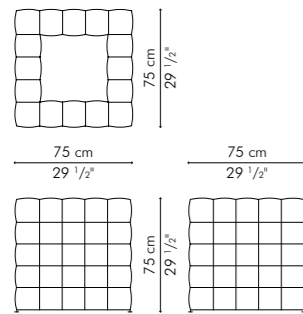

Standard glass size:
137 cm D x 137 cm W x 12 mm thickness
(54" D x 54" W x 1/2"), pencil edge

DINING TABLE, square small

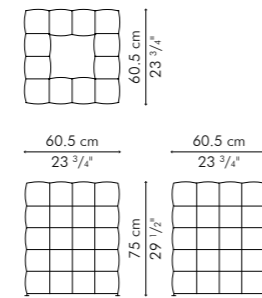

Standard glass size:
122 cm D x 122 cm W x 12 mm thickness
(48" D x 48" W x 1/2"), pencil edge



SIDE CHAIR

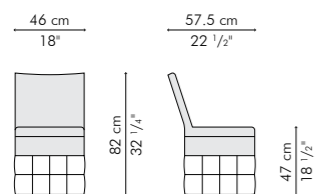

INDOOR rattan, rattan peel, steel



OUTDOOR polyethylene, steel



YIN & YANG



BED, American king

225 cm	200 cm
88 1/2"	78 3/4"
INSIDE FRAME	INSIDE FRAME
204 cm	194 cm
80 1/4"	76 1/4"

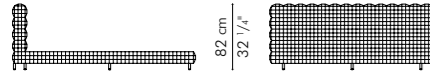

BED, American queen

225 cm	160 cm
88 1/2"	63"
INSIDE FRAME	INSIDE FRAME
204 cm	153.5 cm
80 1/4"	60 1/2"

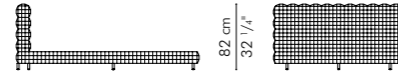

BED, European Extra king

221 cm	206.5 cm
85 3/4"	80 1/4"
INSIDE FRAME	INSIDE FRAME
200 cm	200 cm
78 3/4"	78 3/4"

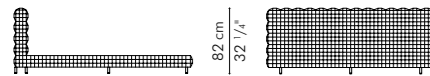

BED, European king

221 cm	186.5 cm
85 3/4"	72 1/4"
INSIDE FRAME	INSIDE FRAME
200 cm	180 cm
78 3/4"	70 3/4"

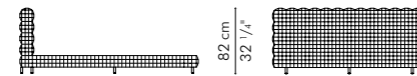

BED, European queen

221 cm	165.5 cm
85 3/4"	64 1/4"
INSIDE FRAME	INSIDE FRAME
200 cm	160 cm
78 3/4"	63"

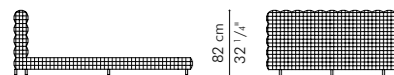

INDOOR rattan, rattan peel, stainless steel, steel



NITE TABLE



50 cm	50 cm
19 3/4"	19 3/4"
50 cm	50 cm
19 3/4"	19 3/4"

INDOOR ash or maple, reconstituted leather



YODA

Tapping the natural tension of the rattan vine, the Yoda supports your back and offers comfort concealed in the seeming randomness of the material.



YODA



EASY CHAIR

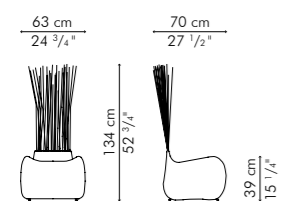

SIDE CHAIR

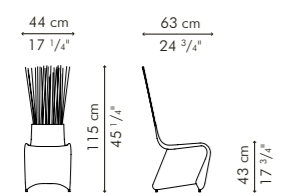

BARSTOOL

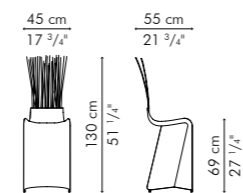

INDOOR rattan, nylon, steel



Blue Monkey, Amirandes, Greece





YODA

SOFA, section center

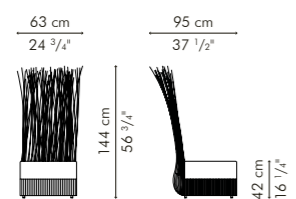

SOFA, section short

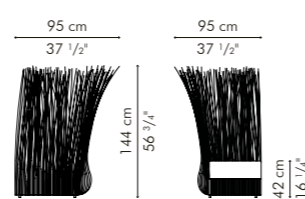

SOFA, section long left

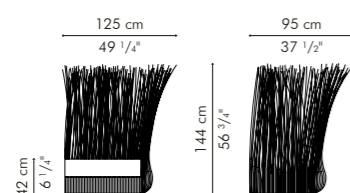

SOFA, section long right

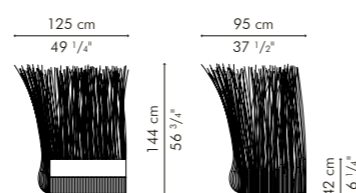

COFFEE TABLE, large

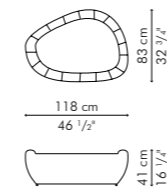

COFFEE TABLE, medium

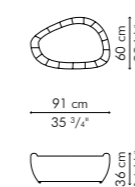

END TABLE



Standard glass size:
62.5 cm D x 95 cm W x 10 mm thickness
(24 1/2" D x 37 1/2" W x 3/8"), frosted, swiped edge

Standard glass size:
43 cm D x 74.5 cm W x 10 mm thickness
(17" D x 29 1/4" W x 3/8"), frosted, swiped edge

Standard glass size:
45.5 cm D x 28 cm W x 6 mm thickness
(18" D x 11" W x 1/4"), frosted, swiped edge

INDOOR rattan, nylon, steel





ZAZA

With its dramatic plume and generous scale, Zaza is not your typical chair. A whimsical take on nature, the seemingly delicate fronds wrapped in microfiber not only provide supple yet ample support, but a theatrical backdrop to any space as well.



ZOEY

Zoey is perfect for lounging in the living room, by the pool, or on the shore as waves ebb to and fro. Sinking into Zoey's tilted backrest is an experience of finding your well-deserved rest.

SIDE CHAIR

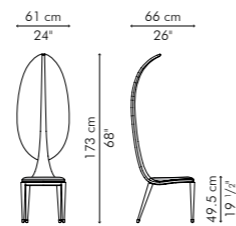

INDOOR microfiber, fiber glass, steel

- Black
- Moss Green
- Lime Green



CHAISE LOUNGE

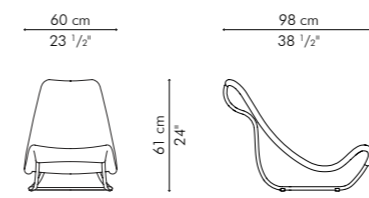

OUTDOOR polyethylene, aluminum



END TABLE

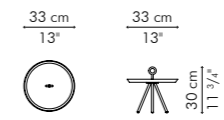

OUTDOOR aluminum, steel, fiberglass

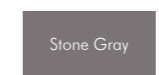



INDEX

Collection	Pages
ACACIA	2
ADESSO	6
AMAYA & DIMPLE	8
ANNIKA	12
APOLLO	14
ARIA	16
BABAR	20
BALOU	22
BLOOM	26
BOUQUET	30
CABARET	32
CALYX	38
CHIQUITA	42
CROISSANT	44
DOLLY	48
DRAGNET	50
DREAMCATCHER	52
FORMA	54
GOBI	60
HAGIA	62
HARRY	66
KAJA	68
LA LUNA	70
LASSO	72
LOLAH	74
LOLITA	78
MARCEL	79
LULU	80
MANOLO	84
MASON	86
MATILDA	88
MERMAID	92
NOODLE	94
OASIS	98
PAPILLON	102
PARCHMENT	104
PEACOCK	108
PEBBLE	110
PIGALLE	112
RAPUNZEL	116
RINGO	118
RUSSELL	120
SUZY WONG	122
TILT	126
TRAME	128
TROPEZ	132
VIVO	134
VOYAGE	138
WAVE	142
YIN & YANG	146
YODA	154
ZAZA	160
ZOEY	161



www.kennethcobonpue.com