



nomon
JEWELRY FOR HOME

**LIGHTING
COLLECTION**

LINEA H

nomon
JEWELRY FOR HOME

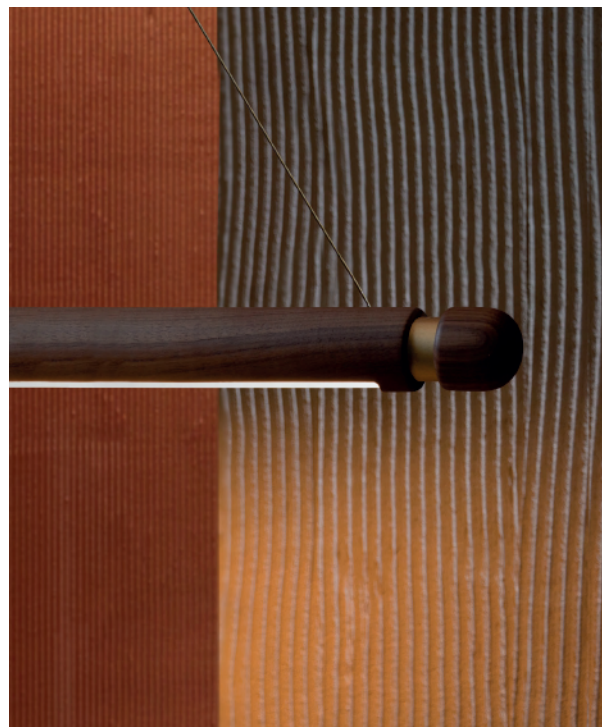
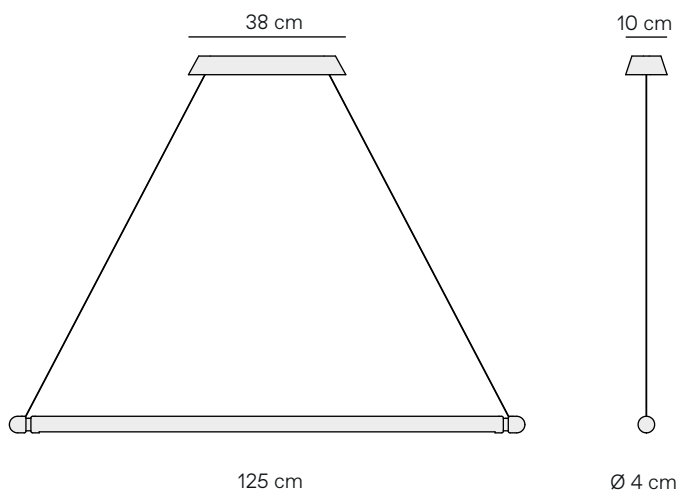

MATERIALS

MATERIALES

LINEA H Gold

Body lamp in natural solid walnut wood.
Details in brass finished metal and steel string.
Cuerpo en nogal natural con detalles en metal
acabado latón. Cable de acero.

LINEA H Black

Body lamp in natural solid walnut wood.
Details in black finish metal and steel string.
Cuerpo en nogal natural con detalles en metal
acabado grafito. Cable de acero.

MATERIALS

Materiales

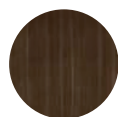

Walnut
Nogal



Metal in brass finish
Metal acabado latón



Metal in graphite finish
Metal acabado grafito

LIGHT TECHNICAL INFORMATION

DETALLES TÉCNICOS DE LA LUZ

Light source: LED Monocolor
Power: 0,0132Kw
Nominal Luminous Flux: 1078-1155lm
CRI: >95
Deviation (SDCM): 3 step MacAdam ellipse
Color temperature: 2700-3000-4000-6000K
Light emission 120°

Fuente de luz: LED Monocolor
Potencia: 0,0132Kw
Flujo Luminoso nominal: 1078-1155lm
CRI: >95
Uniformidad de color: 3 pasos MacAdam
Temperatura de color: 2700-3000-4000-6000K
Apertura: 120°

LINEA V

nomon
JEWELRY FOR HOME

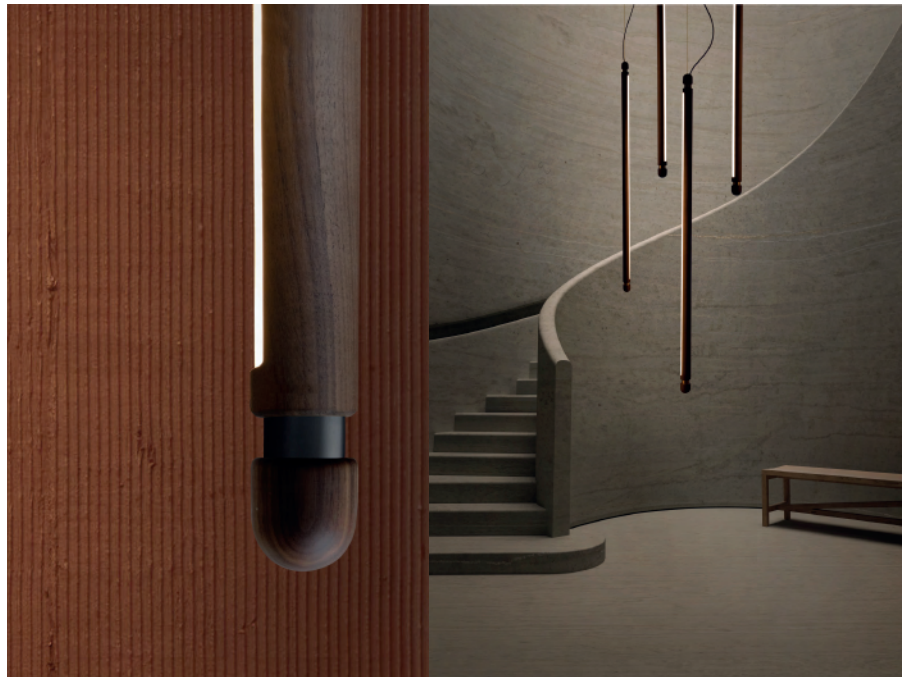
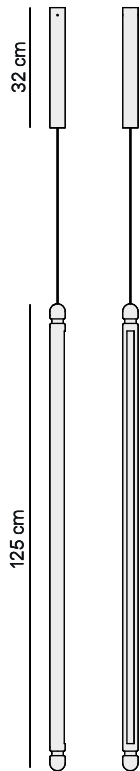

MATERIALS

MATERIALES

LINEA H Gold

Body lamp in natural solid walnut wood.
Details in brass finished metal and steel string.
Cuerpo en nogal natural con detalles en metal
acabado latón. Cable de acero.

LINEA H Black

Body lamp in natural solid walnut wood.
Details in black finish metal and steel string.
Cuerpo en nogal natural con detalles en metal
acabado grafito. Cable de acero.

MATERIALS

Materiales



Walnut
Nogal



Metal in brass finish
Metal acabado latón

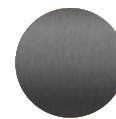

Metal in graphite finish
Metal acabado grafito

LIGHT TECHNICAL INFORMATION

DETALLES TÉCNICOS DE LA LUZ

Light source: LED Monocolor
Power: 0,0132Kw
Nominal Luminous Flux: 1078-1155lm
CRI: >95
Deviation (SDCM): 3 step MacAdam ellipse
Color temperature: 2700-3000-4000-6000K
Light emission 120°

Fuente de luz: LED Monocolor
Potencia: 0,0132Kw
Flujo Luminoso nominal: 1078-1155lm
CRI: >95
Uniformidad de color: 3 pasos MacAdam
Temperatura de color: 2700-3000-4000-6000K
Apertura: 120°

LINEA D

nomon
JEWELRY FOR HOME

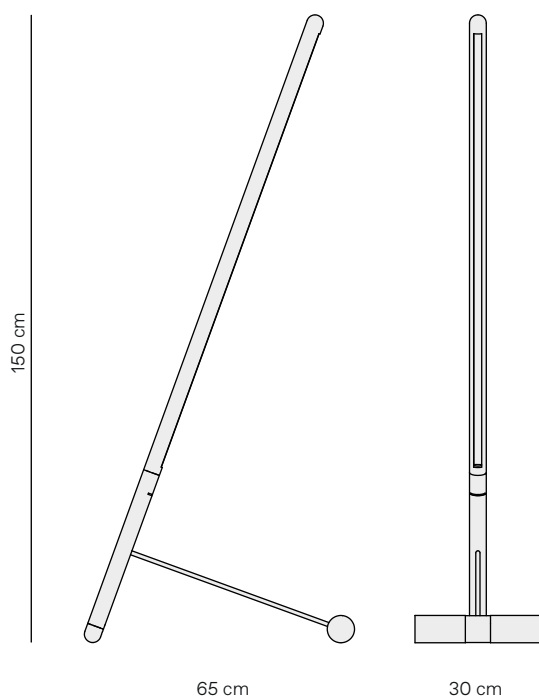

MATERIALS

MATERIALES

LINEA H Gold

Body lamp in natural solid walnut wood.
Details in brass finished metal and steel string.
Cuerpo en nogal natural con detalles en metal
acabado latón. Cable de acero.

LINEA H Black

Body lamp in natural solid walnut wood.
Details in black finish metal and steel string.
Cuerpo en nogal natural con detalles en metal
acabado grafito. Cable de acero.

MATERIALS

Materiales

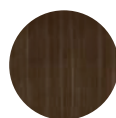

Walnut
Nogal



Metal in brass finish
Metal acabado latón



Metal in graphite finish
Metal acabado grafito

LIGHT TECHNICAL INFORMATION

DETALLES TÉCNICOS DE LA LUZ

Light source: LED Monocolor
Power: 0,0132Kw
Nominal Luminous Flux: 1078-1155lm
CRI: >95
Deviation (SDCM): 3 step MacAdam ellipse
Color temperature: 2700-3000-4000-6000K
Light emission 120°

Fuente de luz: LED Monocolor
Potencia: 0,0132Kw
Flujo Luminoso nominal: 1078-1155lm
CRI: >95
Uniformidad de color: 3 pasos MacAdam
Temperatura de color: 2700-3000-4000-6000K
Apertura: 120°

LINEA UNO

nomon
JEWELRY FOR HOME

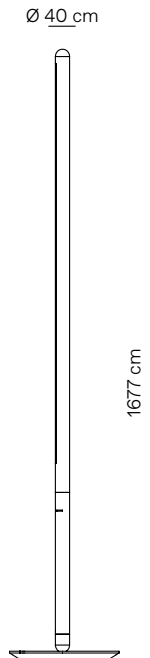

MATERIALS

MATERIALES

LINEA H Gold

Body lamp in natural solid walnut wood.
Details in brass finished metal and steel string.
Cuerpo en nogal natural con detalles en metal
acabado latón. Cable de acero.

LINEA H Black

Body lamp in natural solid walnut wood.
Details in black finish metal and steel string.
Cuerpo en nogal natural con detalles en metal
acabado grafito. Cable de acero.

MATERIALS

Materiales

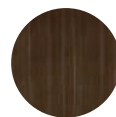

Walnut
Nogal



Metal in brass finish
Metal acabado latón

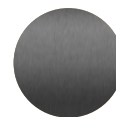

Metal in graphite finish
Metal acabado grafito

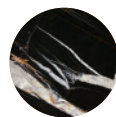

Sahara marble
Mármol Sahara



Calacatta marble
Mármol Calacatta

LIGHT TECHNICAL INFORMATION

DETALLES TÉCNICOS DE LA LUZ

Light source: LED Monocolor
Power: 0,0132Kw
Nominal Luminous Flux: 1078-1155lm
CRI: >95
Deviation (SDCM): 3 step MacAdam ellipse
Color temperature: 2700-3000-4000-6000K
Light emission 120°

Fuente de luz: LED Monocolor
Potencia: 0,0132Kw
Flujo Luminoso nominal: 1078-1155lm
CRI: >95
Uniformidad de color: 3 pasos MacAdam
Temperatura de color: 2700-3000-4000-6000K
Apertura: 120°